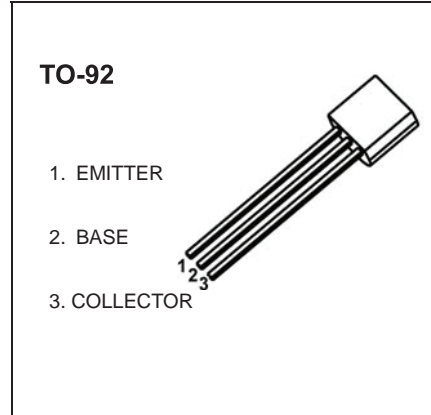
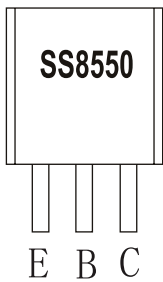

SS8550 TRANSISTOR (PNP)

FEATURES

- Power dissipation
 $P_C : 1\text{ W}$ ($T_a=25^\circ\text{C}$)

MARKING

SS8550= Device code

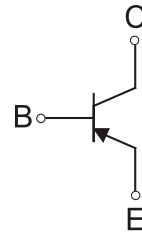
Equivalent Circuit

ORDERING INFORMATION

Part Number	Package	Packing Method	Pack Quantity
SS8550	TO-92	Bulk	1000pcs/Bag
SS8550	TO-92	Tape	2000pcs/Box

MAXIMUM RATINGS ($T_a=25^\circ\text{C}$ unless otherwise noted)

Symbol	Parameter	Value	Unit
V_{CBO}	Collector-Base Voltage	-40	V
V_{CEO}	Collector-Emitter Voltage	-25	V
V_{EBO}	Emitter-Base Voltage	-5	V
I_C	Collector Current -Continuous	-1.5	A
P_D	Collector Power Dissipation	1000	mW
$R_{\theta JA}$	Thermal Resistance from Junction to Ambient	125	$^\circ\text{C} / \text{W}$
T_J, T_{stg}	Operation Junction and Storage Temperature Range	-55~+150	$^\circ\text{C}$

ELECTRICAL CHARACTERISTICS ($T_a=25^{\circ}\text{C}$, unless otherwise specified)

Parameter	Symbol	Test conditions	Min	Typ	Max	Unit
Collector-base breakdown voltage	$V_{(BR)CBO}$	$I_C=-100\mu\text{A}$, $I_E=0$	-40			V
Collector-emitter breakdown voltage	$V_{(BR)CEO}$	$I_C=-0.1\text{mA}$, $I_B=0$	-25			V
Emitter-base breakdown voltage	$V_{(BR)EBO}$	$I_E=-100\mu\text{A}$, $I_C=0$	-5			V
Collector cut-off current	I_{CBO}	$V_{CB}=-40\text{V}$, $I_E=0$			-0.1	μA
Emitter cut-off current	I_{CEO}	$V_{CE}=-20\text{V}$, $I_E=0$			-0.1	μA
Emitter cut-off current	I_{EBO}	$V_{EB}=-5\text{V}$, $I_C=0$			-0.1	μA
DC current gain	$h_{FE(1)}$	$V_{CE}=-1\text{V}$, $I_C=-100\text{mA}$	85		400	
	$h_{FE(2)}$	$V_{CE}=-1\text{V}$, $I_C=-800\text{mA}$	40			
Collector-emitter saturation voltage	$V_{CE(sat)}$	$I_C=-800\text{mA}$, $I_B=-80\text{mA}$			-0.5	V
Base-emitter saturation voltage	$V_{BE(sat)}$	$I_C=-800\text{mA}$, $I_B=-80\text{mA}$			-1.2	V
Base-emitter voltage	$V_{BE(on)}$	$V_{CE}=-1\text{V}$, $I_C=-10\text{mA}$			-1	V
Out capacitance	C_{ob}	$V_{CB}=-10\text{V}$, $I_E=0\text{mA}$, $f=1\text{MHz}$			20	pF
Transition frequency	f_T	$V_{CE}=-10\text{V}$, $I_C=-50\text{mA}$, $f=30\text{MHz}$	100			MHz

 CLASSIFICATION OF $h_{FE(1)}$

Rank	B	C	D
Range	85-160	120-200	160-300

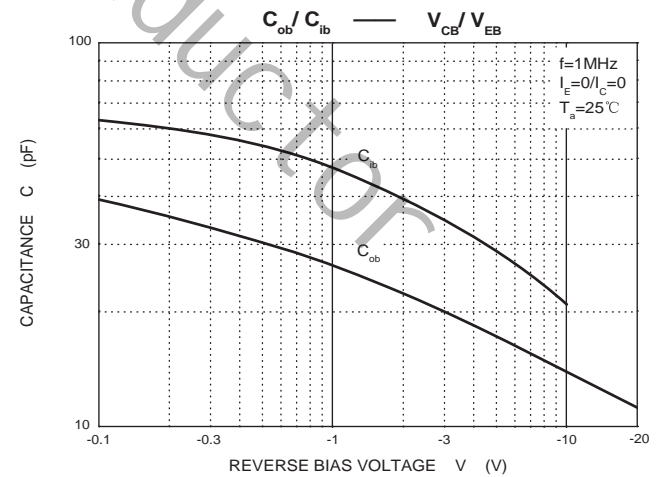
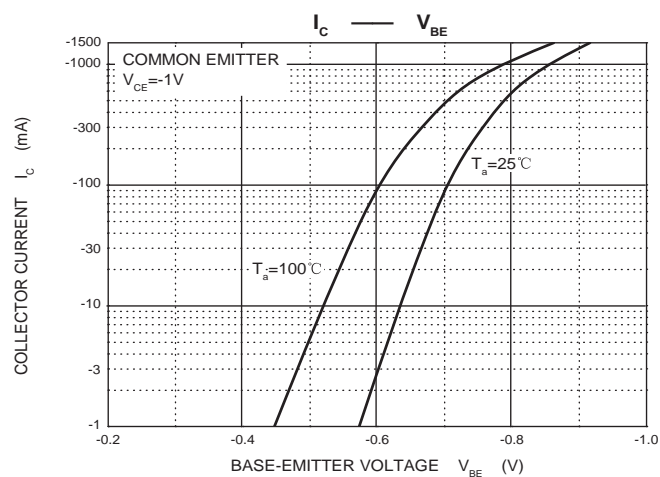
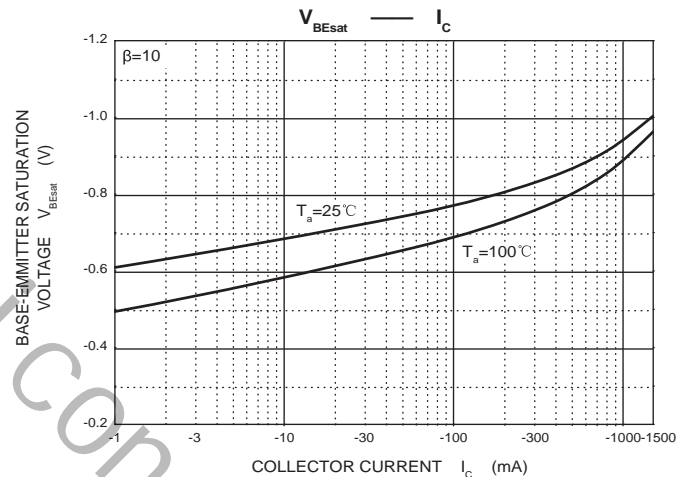
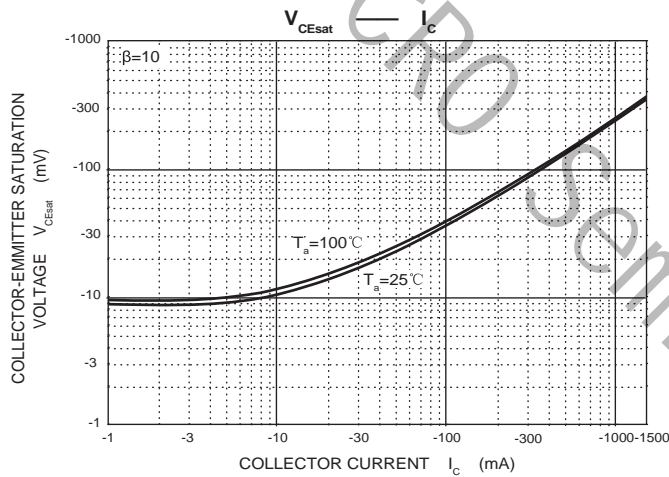
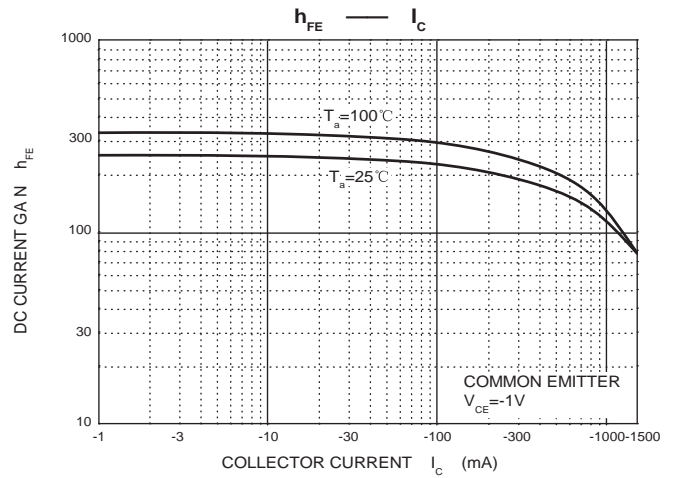
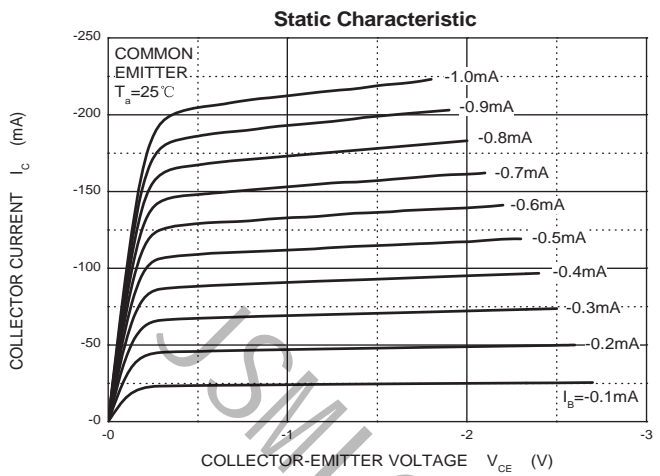
Typical Characteristics

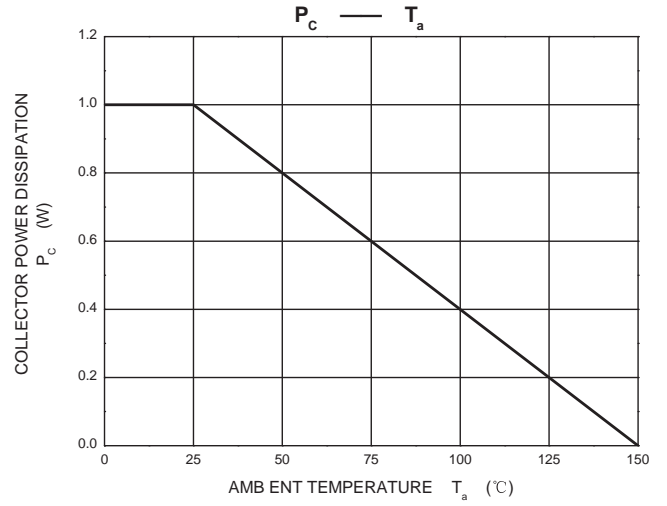
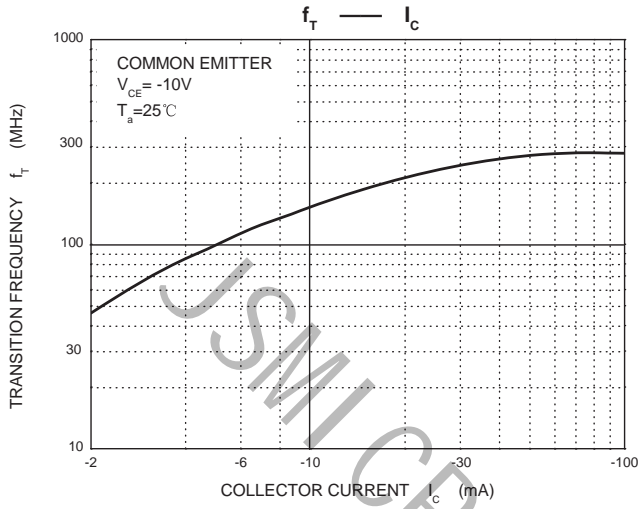
Typical Characteristics(Con.)

TO-92 Package Outline Dimensions

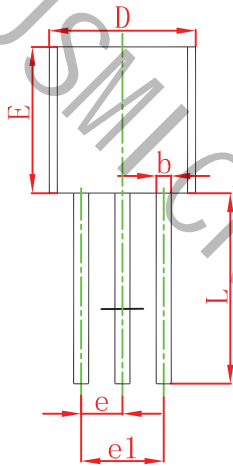
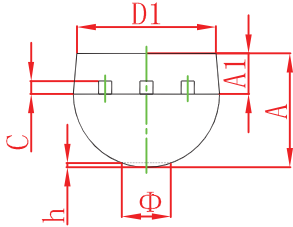

Symbol	Dimensions In Millimeters		Dimensions In Inches	
	Min	Max	Min	Max
A	3.300	3.700	0.130	0.146
A1	1.100	1.400	0.043	0.055
b	0.380	0.550	0.015	0.022
c	0.360	0.510	0.014	0.020
D	4.300	4.700	0.169	0.185
D1	3.430		0.135	
E	4.300	4.700	0.169	0.185
e	1.270 TYP		0.050 TYP	
e1	2.440	2.640	0.096	0.104
L	14.100	14.500	0.555	0.571
Φ		1.600		0.063
h	0.000	0.380	0.000	0.015

TO-92 Suggested Pad Layout

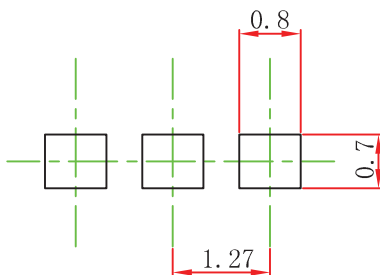

Note:

1. Controlling dimension: in millimeters.
2. General tolerance: $\pm 0.05\text{mm}$.
3. The pad layout is for reference purposes only.

TO-92 Tape and Reel

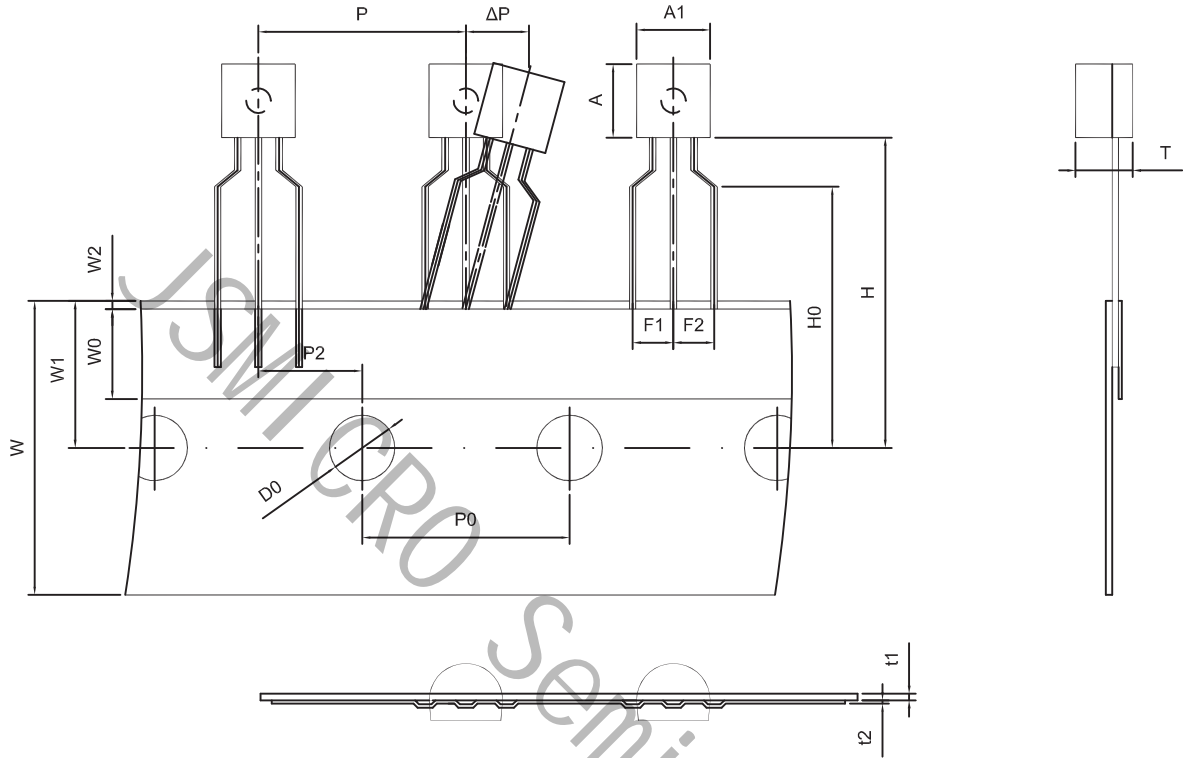

Dimensions are in millimeter

A1	A	T	P	P0	P2	F1	F2	W
4.5	4.5	3.5	12.7	12.7	6.35	2.5	2.5	18.0
W0	W1	W2	H	H0	D0	t1	t2	ΔP
6.0	9.0	1.0 MAX.	19.0	16.0	4.0	0.4	0.2	0

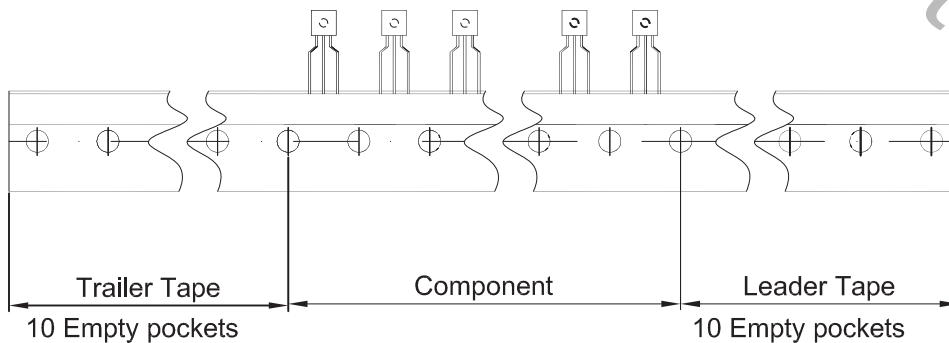

Package	Box	Box Size(mm)	Carton	Carton Size(mm)
TO-92	2000 pcs	333×162×43	20,000 pcs	350×340×250