

描述 / Descriptions

TO-220 塑封封装 NPN 半导体三极管。
 Silicon NPN transistor in a TO-220 Plastic Package.

特征 / Features

宽阔的安全工作区,于 2SA940 互补。
 Wide Safe Operating Area, complementary to 2SA940.

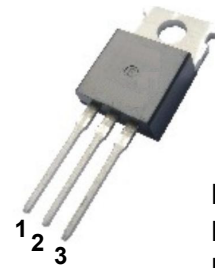

PIN1 : Base
 PIN 2 : Collector
 PIN 3 : Emitter

用途 / Applications

用于功率放大和帧频输出。
 Power amplifier applications, vertical output applications.

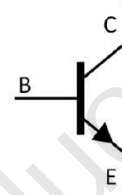
极限参数 / Absolute Maximum Ratings(Ta=25°C)

参数 Parameter	符号 Symbol	数值 Rating	单位 Unit
Collector to Base Voltage	V_{CBO}	150	V
Collector to Emitter Voltage	V_{CEO}	150	V
Emitter to Base Voltage	V_{EBO}	5.0	V
Collector Current - Continuous	I_C	1.5	A
Base Current - Continuous	I_B	0.5	A
Collector Power Dissipation	P_C	2.0	W
	$P_C(T_c=25^\circ\text{C})$	25	W
Junction Temperature	T_j	150	°C
Storage Temperature Range	T_{stg}	-55~150	°C

电性能参数 / Electrical Characteristics(Ta=25°C)

参数 Parameter	符号 Symbol	测试条件 Test Conditions	最小值 Min	典型值 Typ	最大值 Max	单位 Unit
Collector Cut-Off Current	I_{CBO}	$V_{CB}=120V$ $I_E=0$			10	μA
Emitter Cut-Off Current	I_{EBO}	$V_{EB}=5.0V$ $I_C=0$			10	μA
DC Current Gain	h_{FE}	$V_{CE}=10V$ $I_C=500\text{mA}$	40	75	140	
Collector to Emitter Saturation Voltage	$V_{CE(sat)}$	$I_C=500\text{mA}$ $I_B=50\text{mA}$			1.5	V
Base to Emitter Voltage	V_{BE}	$V_{CE}=10V$ $I_C=500\text{mA}$	0.65	0.75	0.85	V
Transition Frequency	f_T	$V_{CE}=10V$ $I_C=500\text{mA}$		4.0		MHz
Collector output capacitance	C_{ob}	$V_{CB}=10V$ $I_E=0$ $f=1.0\text{MHz}$		35		pF

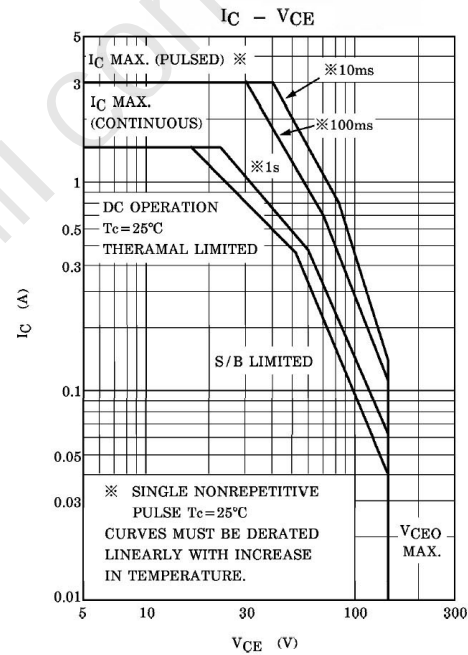
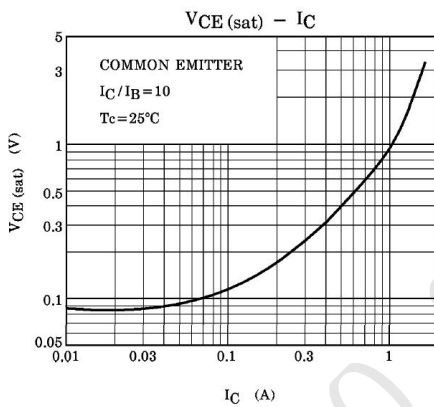
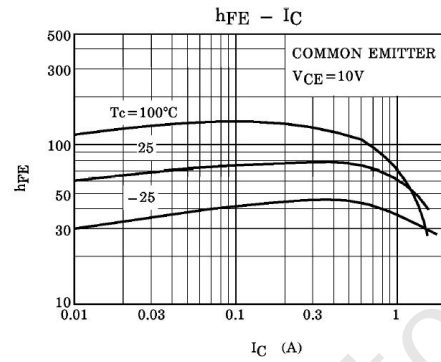
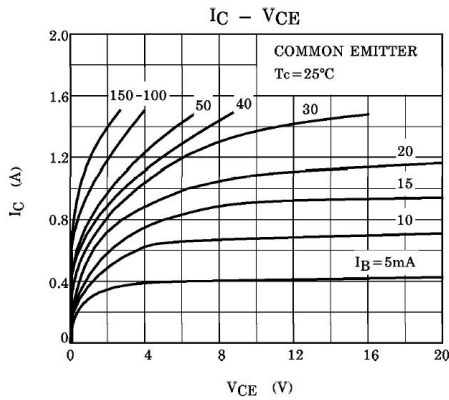
电参数曲线图 / Electrical Characteristic Curve

外形尺寸图 / Package Dimensions

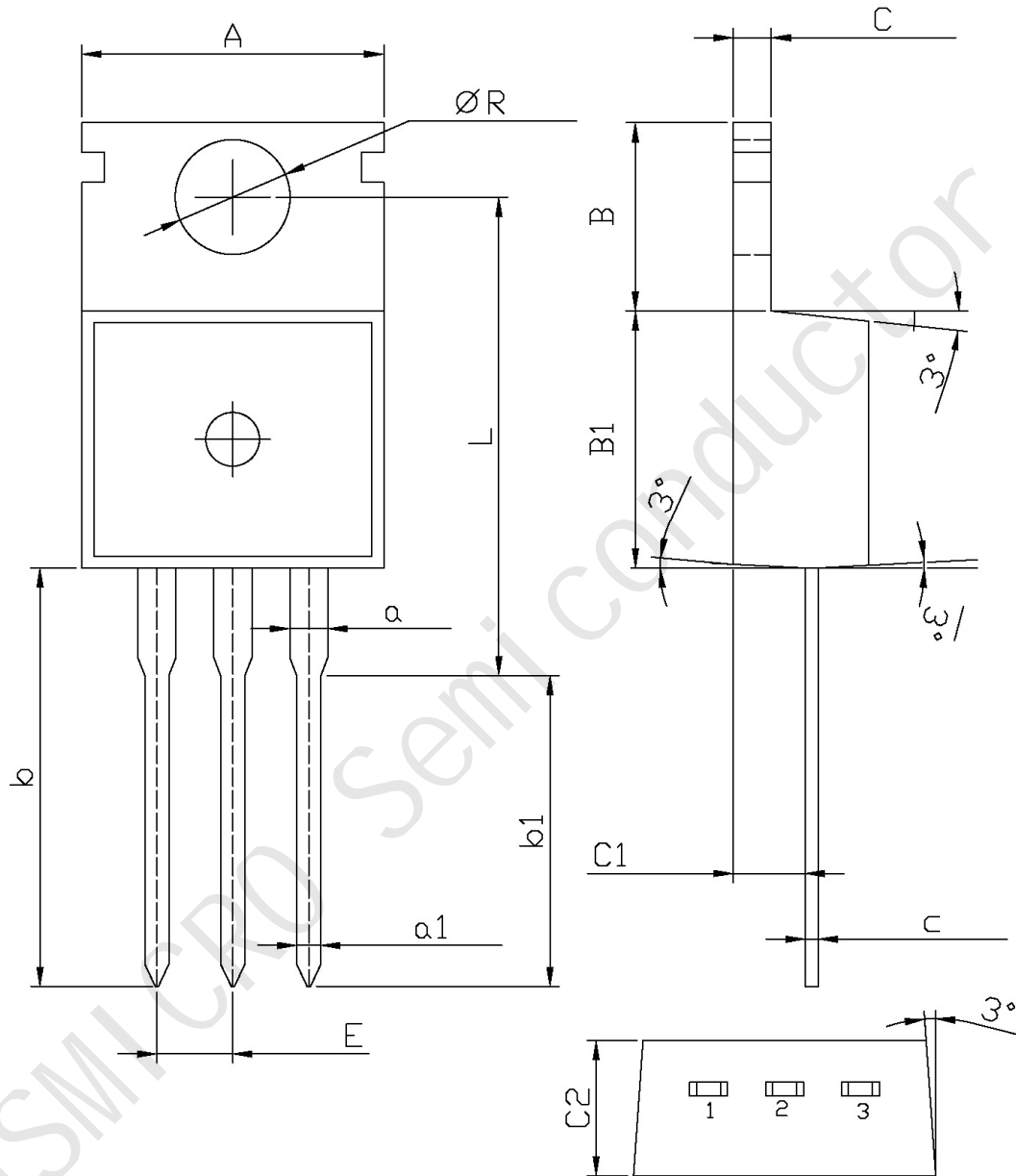

Symbol	Dimensions In Millimeters		Symbol	Dimensions In Millimeters	
	Min	Max		Min	Max
A	9.8	10.2	C	1.2	1.4
R	3.56	3.64	B	6.3	6.7
L	15.7	16.1	B1	9.0	9.4
b	12.6	13.6	C1	2.2	2.6
b1	9.6	10.6	a1	0.7	0.9
a	1.22	1.32	c	0.4	0.6
E	2.34	2.74	C2	4.3	4.7