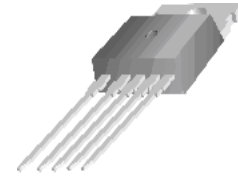
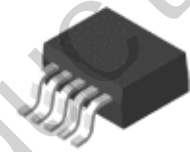

FEATURES

- 3.3V, 5.0V, 12V and Adjustable Output Versions
- Adjustable Version Output Voltage Range, 1.23 to 37V
+/- 4% maximum over line and load conditions
- Guaranteed 3.0A Output Current
- Wide Input Voltage Range
- Requires Only 4 External Components
- 52kHz Fixed Frequency Internal Oscillator
- TTL Shutdown Capability, Low Power Standby Mode
- High Efficiency
- Uses Readily Available Standard Inductors
- Thermal Shutdown and Current Limit Protection
- Moisture Sensitivity Level 3 for SMD packages

TO-220 PKG**TO-263 PKG**

APPLICATION

- Simple High-Efficiency Step-Down(Buck) Regulator
- Efficient Pre-Regulator for Linear Regulators
- On-Card Switching Regulators
- Positive to Negative Converter(Buck-Boost)
- Negative Step-Up Converters
- Power Supply for Battery Chargers

DESCRIPTION

The LM2576T-ADJ series of regulators are monolithic integrated circuits ideally suited for easy and convenient design of a step-down switching regulator (buck converter).

All circuits of this series are capable of driving a 3.0A load with excellent line and load regulation. These devices are available in fixed output voltages of 3.3V, 5.0V, 12V and an adjustable output version.

These regulators were designed to minimize the number of external components to simplify the power supply design. Standard series of inductors optimized for use with the LM2576T-ADJ are offered by several different inductor manufacturers.

Since the LM2576T-ADJ converter is a switch-mode power supply, its efficiency is significantly higher in comparison with popular three-terminal linear regulators, especially with higher input voltages.

In many cases, the power dissipated is so low that no heatsink is required or its size could be reduced dramatically. A standard series of inductors optimized for use with the LM2576T-ADJ are available from several different manufacturers. This feature greatly simplifies the design of switch-mode power supplies. The LM2576T-ADJ features include a guaranteed +/- 4% tolerance on output voltage within specified input voltages and output load conditions, and +/-10% on the oscillator frequency (+/- 2% over 0°C to 125°C).

External shutdown is included, featuring 80 μ A (typical) standby current. The output switch includes cycle-by-cycle current limiting, as well as thermal shutdown for full protection under fault conditions.

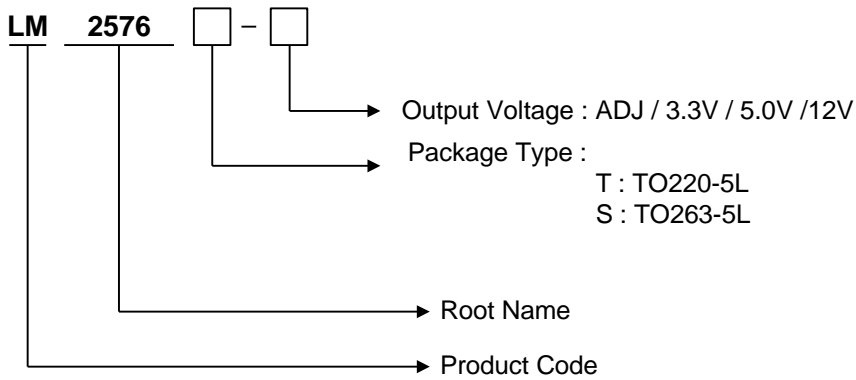

JSMICRO Semi-conductor

PIN CONFIGURATION

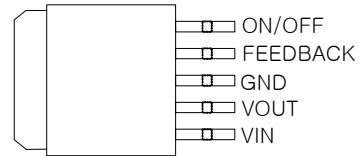

TO220-5L



TO263-5L

PIN DESCRIPTION

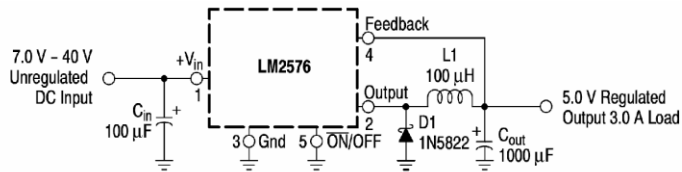
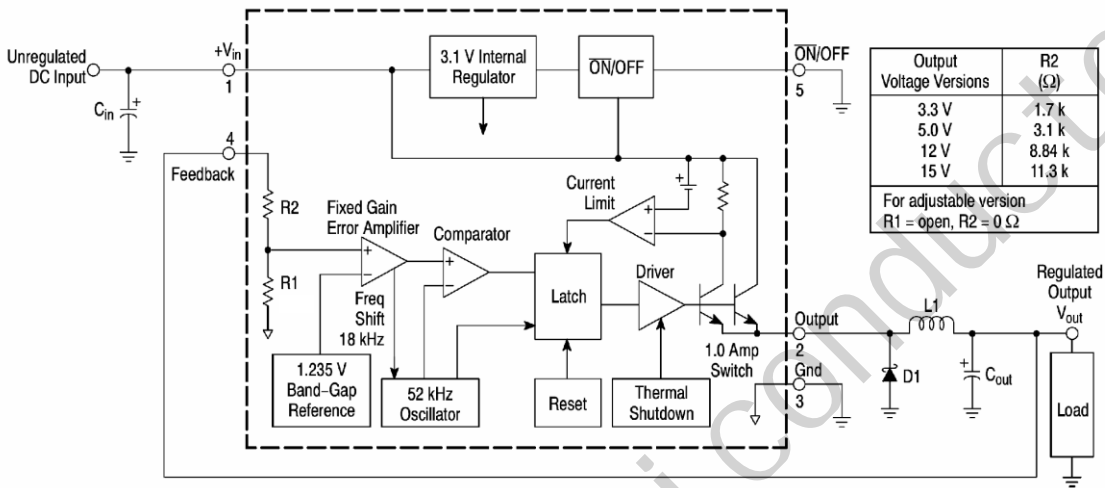
Package	Symbol	Description
TO-220 5L TO-263 5L		
1	VIN	This pin is the positive input supply for the JSM2576 step-down switching regulator. In order to minimize voltage transients and to supply the switching currents needed by the regulator, a suitable input bypass capacitor must be present. (C _{in} in Figure 1).
2	VOUT	This is the emitter of the internal switch. The saturation voltage V _{SAT} of this output switch is typically 1.5V. It should be kept in mind that the PCB area connected to this pin should be kept to a minimum in order to minimize coupling to sensitive circuitry.
3	GND	Circuit ground pin. See the information about the printed circuit board layout.
4	FEEDBACK	This pin senses regulated output voltage to complete the feedback loop. The signal is divided by the internal resistor divider network R ₂ , R ₁ and applied to the non-inverting input of the internal error amplifier. In the adjustable version of the LM2576 switching regulator this pin is the direct input of the error amplifier and the resistor network R ₂ , R ₁ is connected externally to allow programming of the output voltage.
5	ON/OFF	It allows the switching regulator circuit to be shutdown using logic level signals, thus dropping the total input supply current to approximately 80uA. The threshold voltage is typically 1.4V. Applying a voltage above this value (up to +V _{in}) shuts the regulator off. If the voltage applied to this pin is lower than 1.4V or if this pin is left open, the regulator will be in the "on" condition

Typical Application (Fixed Output Voltage Versions)

Representative Block Diagram and Typical Application

ABSOLUTE MAXIMUM RATINGS

(Absolute Maximum Ratings indicate limits beyond which damage to the device may occur)

Rating	Symbol	Value	UNIT
Maximum Supply Voltage	V _{in}	45	V
On/Off Pin Input Voltage	-	-0.3V ≤ V ≤ +V _{in}	V
Output Voltage to Ground (Steady-State)	-	-1.0	V
TO-220 5Lead Thermal Resistance, Junction to Ambient	P _D θ _{JA}	Internally Limited 65	W °C/W
Thermal Resistance, Junction to Case	θ _{JC}	5	°C/W
TO-263 5Lead Thermal Resistance, Junction to Ambient	P _D θ _{JA}	Internally Limited 70	W °C/W
Thermal Resistance, Junction to Case	θ _{JC}	5	°C/W
Storage Temperature Range	T _{STG}	-60 to +150	°C
Minimum ESD Rating(Human Body Model: C=100 pF, R=1.5kΩ)	-	2.0	kV
Lead Temperature (Soldering, 10seconds)	-	260	°C
Maximum Junction Temperature	T _J	150	°C

OPERATING RATINGS (Operating Ratings indicate conditions for which the device is intended to be functional, but do not guarantee specific performance limits. For guaranteed specifications, see the Electrical Characteristics.)

Rating	Symbol	Value.	Unit
Operating Junction Temperature Range	T _J	-40 to +125	°C
Supply Voltage	V _{in}	40	V

ELECTRICAL CHARACTERISTICS / SYSTEM PARAMETERS ([Note 1] Test Circuit Figure 15)

(Unless otherwise specified, $V_{in} = 12V$ for the 3.3V, 5.0V, and Adjustable version, $V_{in} = 25V$ for the 12V version. $I_{LOAD} = 500\text{ mA}$. For typical values $T_J = 25^\circ\text{C}$, for min/max values T_J is the operating junction temperature range that applies [Note 2], unless otherwise noted.)

Characteristics	Symbol	Min	TYP	Max	Unit
JSM2576-3.3V ([Note 1] Test Circuit Figure 2)					
Output Voltage ($V_{in} = 12V, I_{LOAD}=0.5A, T_J=25^\circ\text{C}$)	Vout	3.234	3.3	3.366	V
Output Voltage ($6.0V \leq V_{in} \leq 40V, 0.5A \leq I_{LOAD} \leq 3.0A$ $T_J=25^\circ\text{C}$ $T_J= -40^\circ\text{C} \sim +125^\circ\text{C}$)	Vout	3.168 3.135	3.3 -	3.432 3.465	V
Efficiency ($V_{in}=12V, I_{LOAD}=3.0A$)	η	-	75	-	%

JSM2576-5.0V ([Note 1] Test Circuit Figure 2)					
Output Voltage ($V_{in} = 12V, I_{LOAD}=0.5A, T_J=25^\circ\text{C}$)	Vout	4.9	5.0	5.1	V
Output Voltage ($8.0V \leq V_{in} \leq 40V, 0.5A \leq I_{LOAD} \leq 3.0A$ $T_J=25^\circ\text{C}$ $T_J= -40^\circ\text{C} \sim +125^\circ\text{C}$)	Vout	4.8 4.75	5.0 -	5.2 5.25	V
Efficiency ($V_{in}=12V, I_{LOAD}=3.0A$)	η	-	77	-	%

JSM2576-12V ([Note 1] Test Circuit Figure 2)					
Output Voltage ($V_{in} = 25V, I_{LOAD}=0.5A, T_J=25^\circ\text{C}$)	Vout	11.76	12	12.24	V
Output Voltage ($15V \leq V_{in} \leq 40V, 0.5A \leq I_{LOAD} \leq 3.0A$ $T_J=25^\circ\text{C}$ $T_J= -40^\circ\text{C} \sim +125^\circ\text{C}$)	Vout	11.52 11.4	12 -	12.48 12.6	V
Efficiency ($V_{in}=25V, I_{LOAD}=3.0A$)	η	-	88	-	%

JSM2576T-ADJ ([Note 1] Test Circuit Figure 2)					
Feedback Voltage ($V_{in}=12V, I_{LOAD}=0.5A, T_J=25^\circ\text{C}$)	Vout	1.217	1.23	1.243	V
Feedback Voltage ($8.0V \leq V_{in} \leq 40V, 0.5A \leq I_{LOAD} \leq 3.0A, V_{out}=5.0V$) $T_J=25^\circ\text{C}$ $T_J= -40^\circ\text{C} \sim +125^\circ\text{C}$)	Vout	1.193 1.18	1.23 -	1.267 1.28	V
Efficiency ($V_{in}=12V, I_{LOAD}=3.0A, V_{out}=5.0V$)	η	-	77	-	%

- External components such as the catch diode, inductor, input and output capacitors can affect switching regulator system performance.
When the JSM2576 is used as shown in the Figure 15 test circuit, system performance will be as shown in system parameters section.
- Tested junction temperature range for the JSM2576: $T_{low} = -40^\circ\text{C}$ $T_{high} = +125^\circ\text{C}$

ELECTRICAL CHARACTERISTICS / Device Parameters

(Unless otherwise specified, $V_{in} = 12V$ for the 3.3V, 5.0V, and Adjustable version, $V_{in} = 25V$ for the 12V version. $I_{Load} = 500\text{ mA}$. For typical values $T_J = 25^\circ\text{C}$, for min/max values T_J is the operating junction temperature range that applies [Note 2], unless otherwise noted.)

Characteristics	Symbol	MIN.	TYP.	MAX.	Unit
All Output Voltage Versions					
Feedback Bias Current ($V_{out}=5.0V$ [Adjustable Version Only]) $T_J=25^\circ\text{C}$ $T_J= -40\text{ to }+125^\circ\text{C}$	I_b	- -	25 -	100 200	nA
Oscillator Frequency [Note 3] $T_J=25^\circ\text{C}$ $T_J= 0\text{ to }+125^\circ\text{C}$ $T_J= -40\text{ to }+125^\circ\text{C}$	F_{OSC}	- 47 42	52 - -	- 58 63	kHz
Saturation Voltage ($I_{out}=3.0A$ [note 4]) $T_J= 25^\circ\text{C}$ $T_J= -40\text{ to }+125^\circ\text{C}$	V_{SAT}	- -	1.5 -	1.8 2	V
Max Duty Cycle ("0") [Note 5]	DC	94	98	-	%
Current Limit (Peak Current [Note 3 and 4]) $T_J= 25^\circ\text{C}$ $T_J= -40\text{ to }+125^\circ\text{C}$	I_{CL}	4.2 3.5	5.8 -	6.9 7.5	A
Output Leakage Current [Note 6 and 7], $T_J=25^\circ\text{C}$ Output = 0V Output = -1.0V	I_L	- -	0.8 6	50 30	mA
Quiescent Current [Note 6] $T_J= 25^\circ\text{C}$ $T_J= -40\text{ to }+125^\circ\text{C}$	I_Q	- -	5 -	9 11	mA
Standby Quiescent Current (ON/OFF Pin = 5.0V ("off")) $T_J=25^\circ\text{C}$ $T_J= -40\text{ to }+125^\circ\text{C}$	I_{STBY}	- -	80 -	200 400	μA
ON/OFF Pin Logic Input Level (Test circuit Figure 15) $V_{out}=0V$ $T_J=25^\circ\text{C}$ $T_J= -40\text{ to }+125^\circ\text{C}$	V_{IH}	2.2 2.4	1.4 -	- -	V
$V_{out}=\text{Nominal Output Voltage}$ $T_J=25^\circ\text{C}$ $T_J= -40\text{ to }+125^\circ\text{C}$	V_{IL}	- -	1.2 -	1 0.8	V
ON/OFF Pin Input Current (Test Circuit Figure 15) ON/OFF Pin = 5.0V (Regulator OFF), $T_J=25^\circ\text{C}$ ON/OFF Pin = 0V (Regulator ON), $T_J=25^\circ\text{C}$	I_{IH} I_{IL}	- -	15 0	30 0.5	μA

- The oscillator frequency reduces to approximately 18 kHz in the event of an output short or an overload which causes the regulated output voltage to drop approximately 40% from the nominal voltage. This self protection feature lowers the average dissipation of the IC by lowering the minimum duty cycle from 5% down to approximately 2%
- Output sourcing current. No diode, inductor or capacitor connected to output pin.
- Feedback removed from output and connected to 0V.
- Feedback removed from output and connected to +12V for the Adjustable, 3.3V, and 5.0V versions, and +25V for the 12V version, to force the output transistor "off".
- $V_{in} = 40V$.

TYPICAL PERFORMANCE CHARACTERISTICS (Circuit of Figure 15)

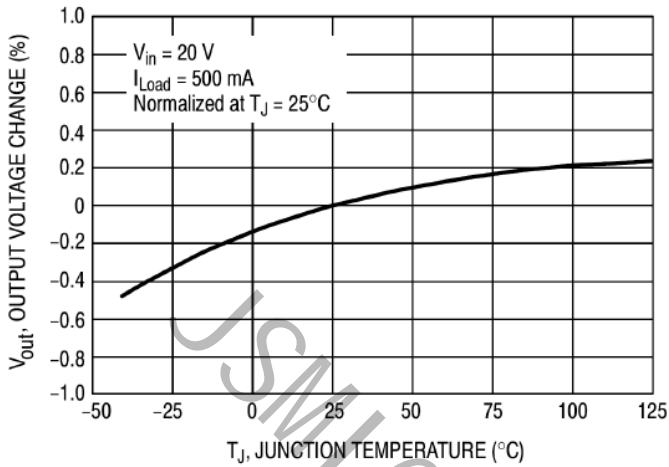

Figure 2. Normalized Output Voltage

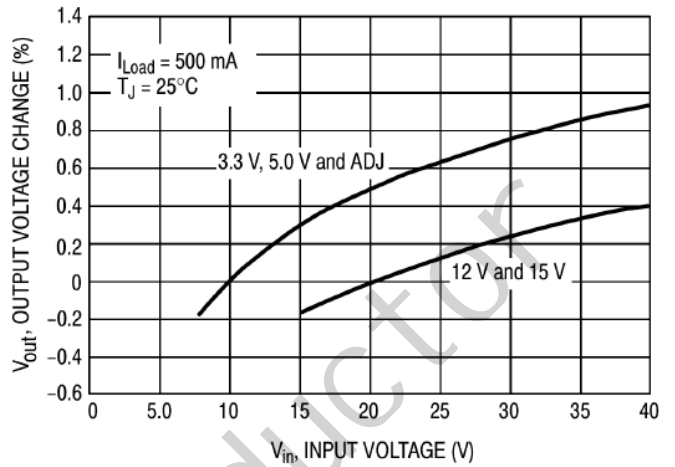

Figure 3. Line Regulation

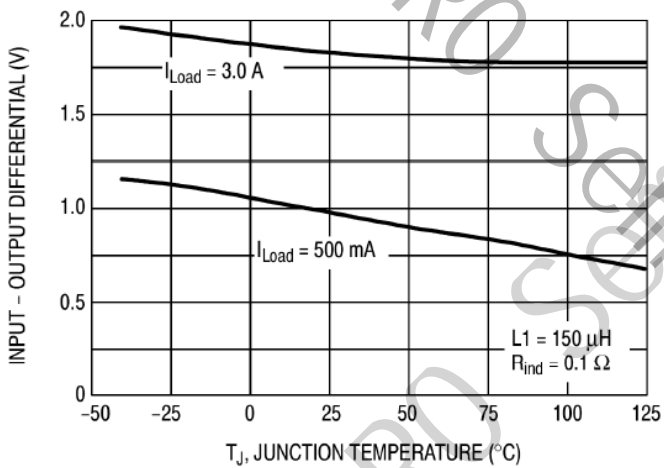

Figure 4. Dropout Voltage

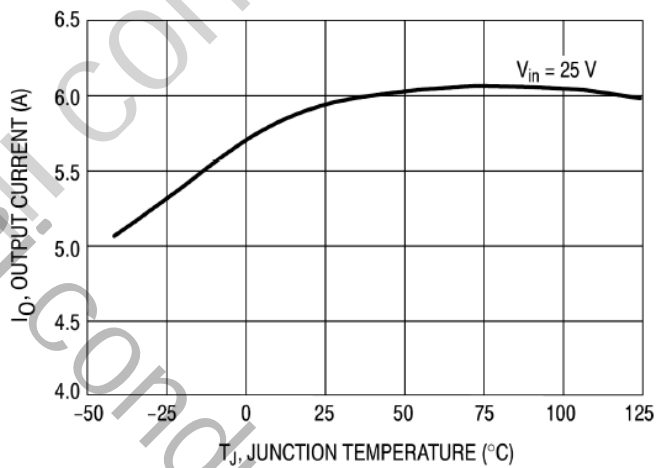

Figure 5. Current Limit

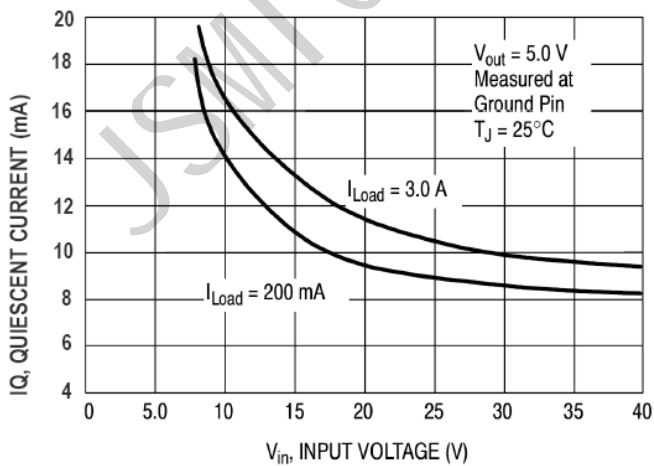

Figure 6. Quiescent Current

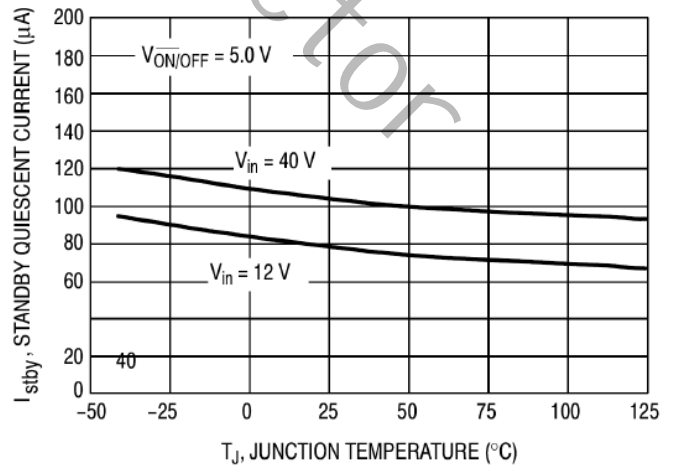

Figure 7. Standby Quiescent Current

TYPICAL PERFORMANCE CHARACTERISTICS (Circuit of Figure 15)

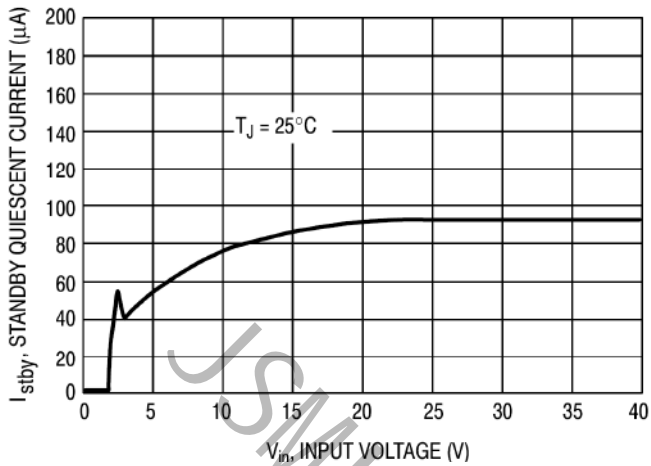

Figure 8. Standby Quiescent Current

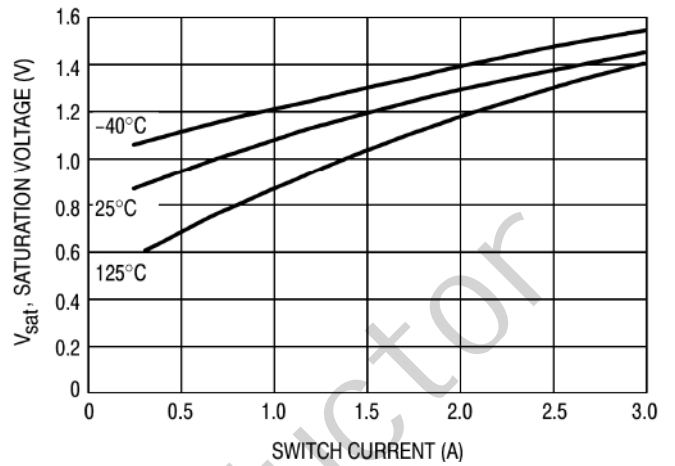

Figure 9. Switch Saturation Voltage

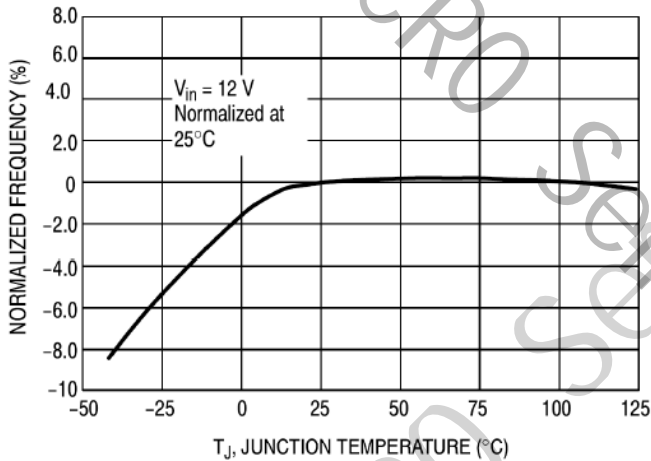

Figure 10. Oscillator Frequency

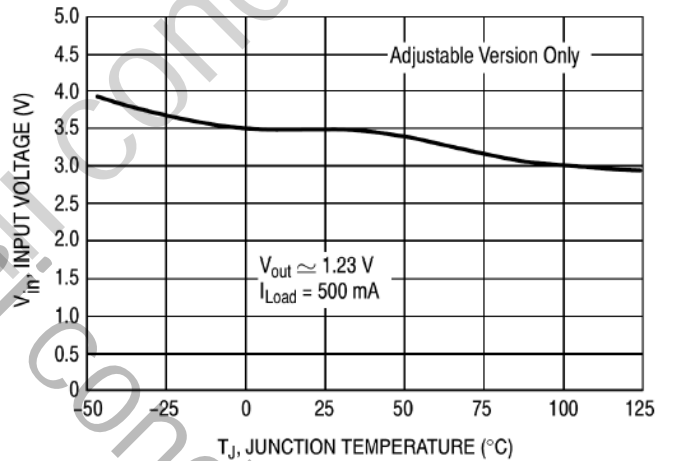

Figure 11. Minimum Operating Voltage

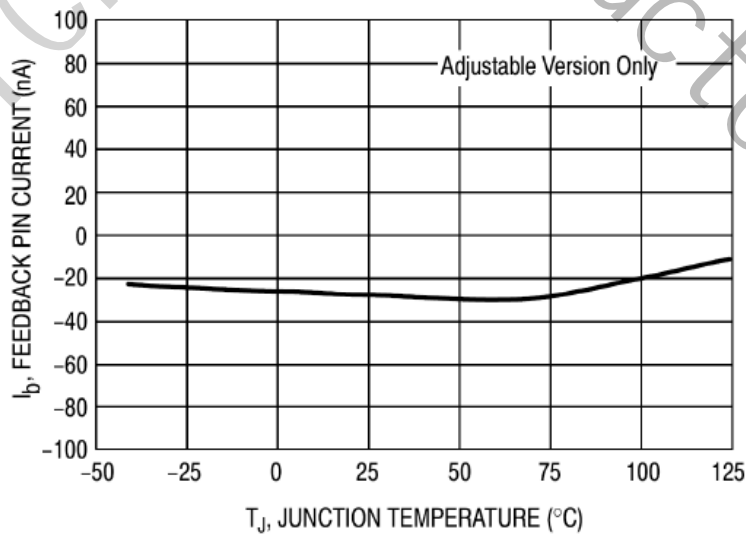
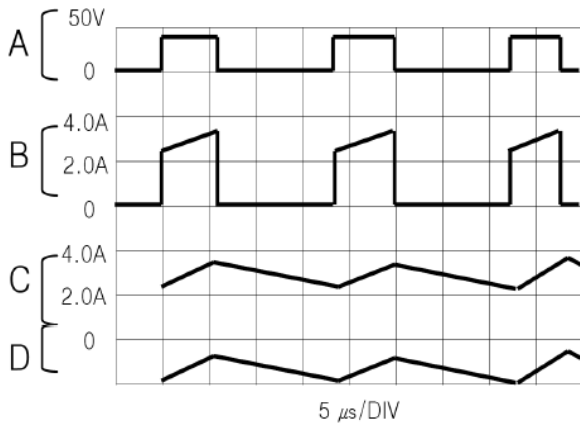
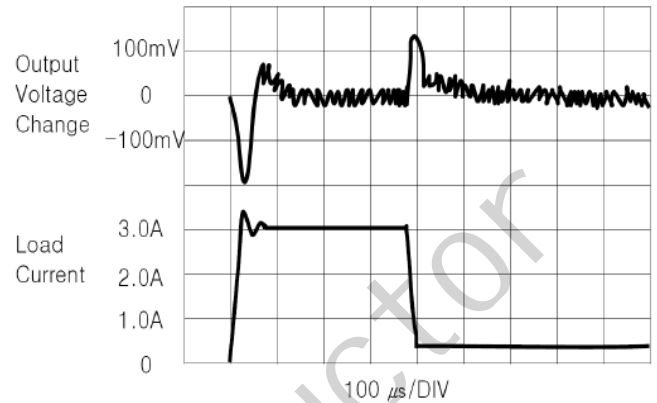

Figure 12. Feedback Pin Current

TYPICAL PERFORMANCE CHARACTERISTICS

Figure 13. Switching Waveforms

Figure 14. Load Transient Response

$V_{out} = 15V$

A : Output Pin Voltage, 10V/DIV

B: Inductor Current, 2.0A/DIV

C: Inductor Current, 2.0A/DIV

D: Output Ripple Voltage, 50mV/DIV, AC-Coupled

Horizontal Time Base : 5.0 μ s/DIV

Outline Drawing:TO-220-5

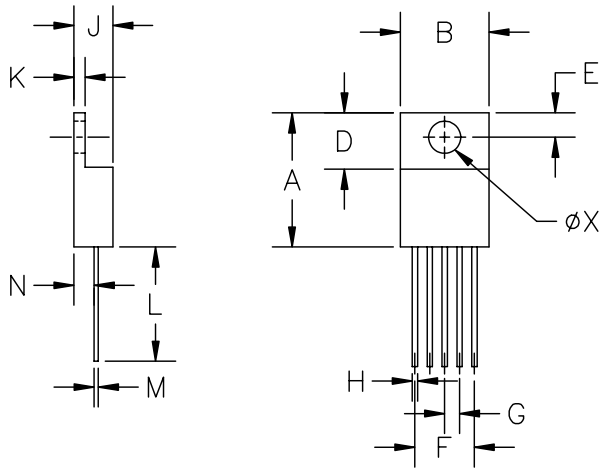

DIM ^N	INCHES		MM		NOTE
	MIN	MAX	MIN	MAX	
A	.560	.650	14.22	16.51	—
B	.380	.420	9.65	10.67	—
D	.230	.260	5.84	6.60	—
E	.100	.135	2.54	3.43	—
F	.263	.273	6.68	6.94	—
G	.062	.072	1.57	1.83	—
H	.025	.040	.63	1.02	—
J	.140	.190	3.55	4.83	—
K	.045	.055	1.14	1.40	—
L	.540	.560	13.72	14.22	—
M	.014	.022	.35	.56	—
N	.080	.120	2.03	3.05	—
φX	.139	.161	3.53	4.09	—

JEDEC TO-220

Outline Drawing:TO-263-5

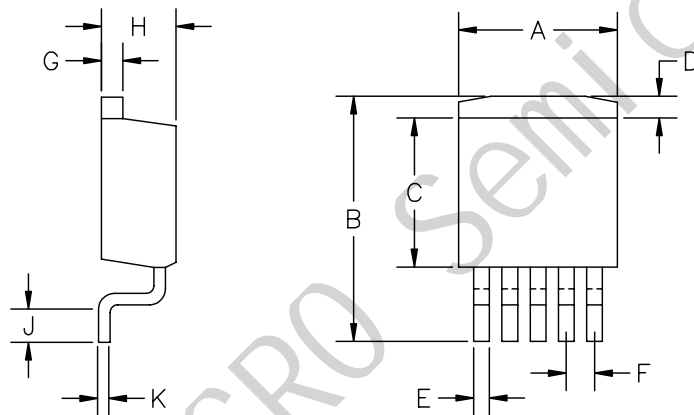

DIM ^N	INCHES		MM		NOTE
	MIN	MAX	MIN	MAX	
A	.380	.405	9.65	10.29	—
B	.575	.625	14.60	15.88	—
C	.325	.380	8.25	9.66	—
D	—	.055	—	1.40	—
E	.020	.039	.50	.99	—
F	.060	.072	1.52	1.83	—
G	.045	.055	1.14	1.40	—
H	.160	.190	4.06	4.83	—
J	.090	.110	2.28	2.80	—
K	.018	.029	.457	.736	—

JEDEC TO-263