

SWITCHING DIODE

FEATURES

- Fast Switching Speed
- Surface Mount Package Ideally Suited for Automatic Insertion
- For General Purpose Switching Applications
- High Conductance

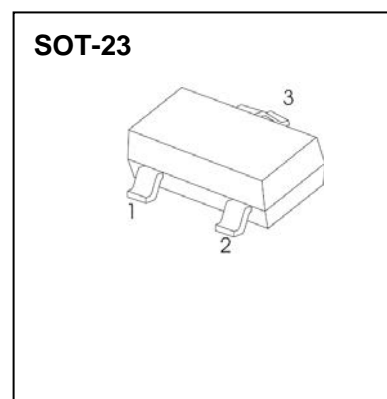

BAS21	BAS21A	BAS21C	BAS21S
MARKING: JS	MARKING: JS2	MARKING: JS3	MARKING: JS4

Maximum Ratings @Ta=25°C

Parameter	Symbol	Limit	Unit
Repetitive peak reverse voltage	V_{RRM}	250	V
Working peak reverse voltage	V_{RWM}		
DC blocking voltage	V_R		
Forward continuous current	I_{FM}	400	mA
Average rectified output current	I_O	200	mA
Non-Repetitive Peak Forward Surge Current @ t=8.3ms	I_{FSM}	2.5	A
Repetitive peak forward surge current	I_{FRM}	625	mA
Power dissipation	P_D	225	mW
Thermal resistance junction to ambient	$R_{\theta JA}$	555	°C/W
Operation Junction and Storage Temperature Range	T_J, T_{STG}	-55~+150	°C

ELECTRICAL CHARACTERISTICS (Ta=25°C unless otherwise specified)

Parameter	Symbol	Test conditions	Min	Max	Unit
Reverse breakdown voltage	$V_{(BR)}$	$I_R = 100\mu A$	250		V
Reverse voltage leakage current	I_R	$V_R = 200V$		0.1	μA
Forward voltage	V_F	$I_F = 100mA$ $I_F = 200mA$		1000 1250	mV
Diode capacitance	C_D	$V_R = 0V, f = 1MHz$		5	pF
Reverse recovery time	t_{rr}	$I_F = I_R = 30mA, I_{rr} = 0.1 \times I_R, R_L = 100\Omega$		50	ns

Typical Characteristics

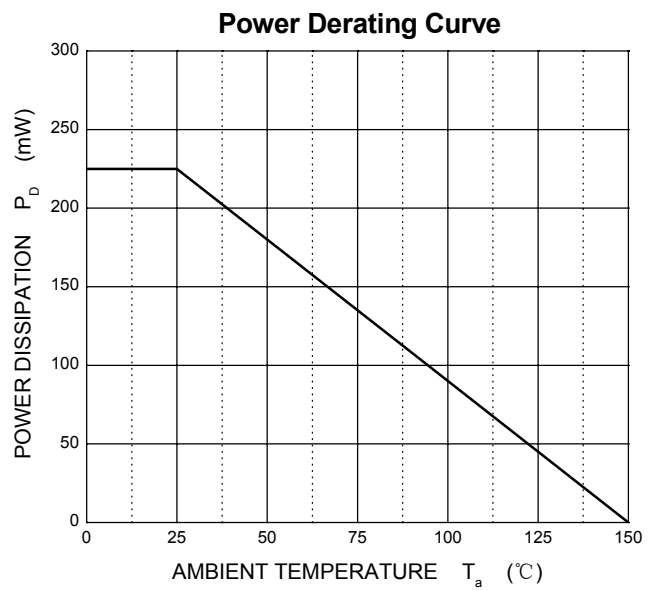
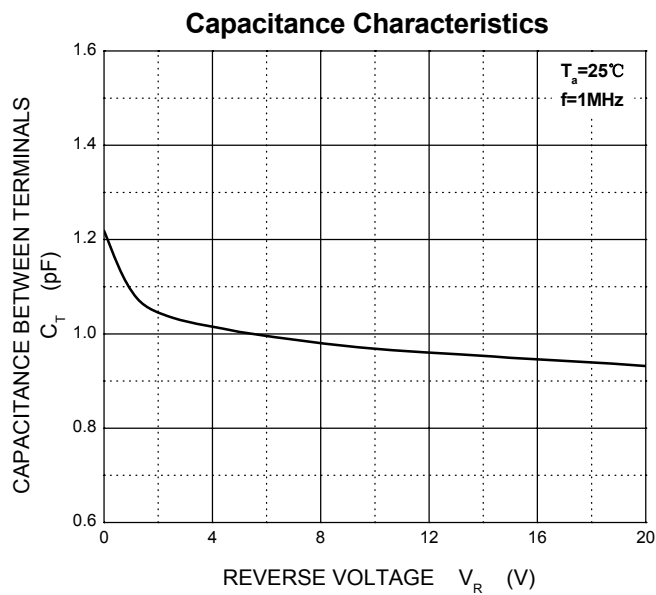
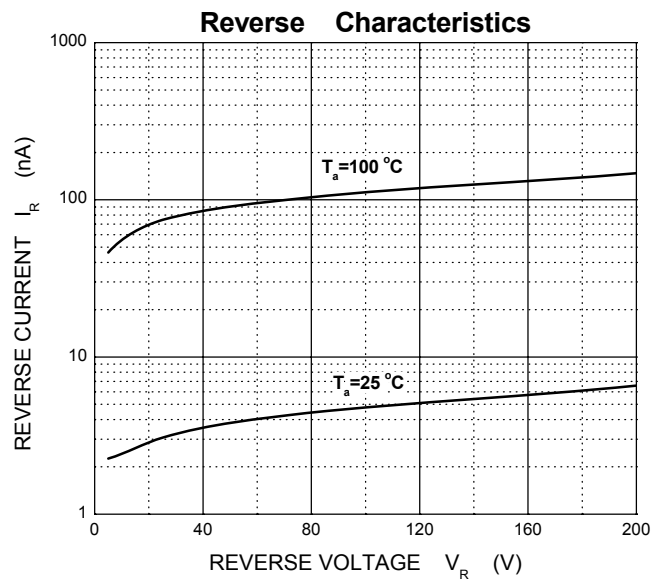
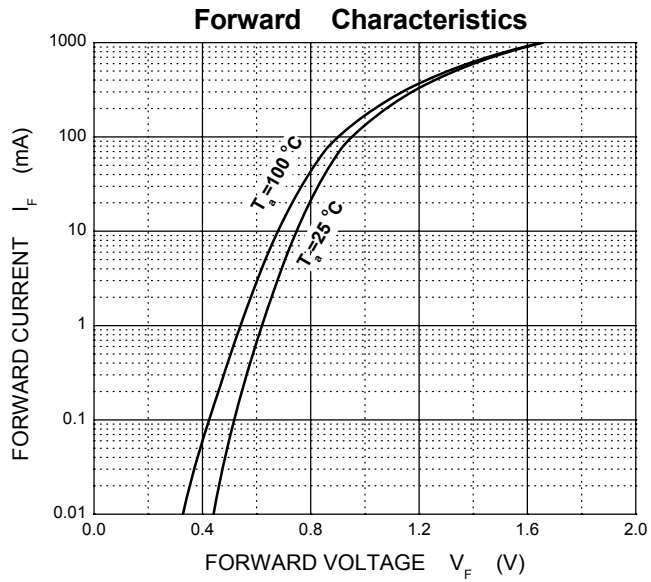

SOT-23 Package Outline Dimensions

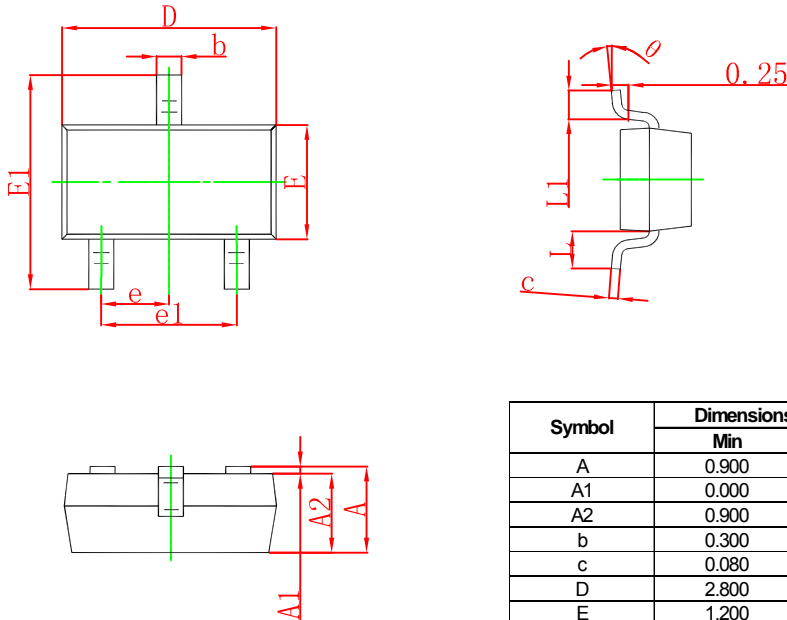

Symbol	Dimensions In Millimeters		Dimensions In Inches	
	Min	Max	Min	Max
A	0.900	1.150	0.035	0.045
A1	0.000	0.100	0.000	0.004
A2	0.900	1.050	0.035	0.041
b	0.300	0.500	0.012	0.020
c	0.080	0.150	0.003	0.006
D	2.800	3.000	0.110	0.118
E	1.200	1.400	0.047	0.055
E1	2.250	2.550	0.089	0.100
e	0.950 TYP		0.037 TYP	
e1	1.800	2.000	0.071	0.079
L	0.550 REF		0.022 REF	
L1	0.300	0.500	0.012	0.020
θ	0°	8°	0°	8°

SOT-23 Suggested Pad Layout

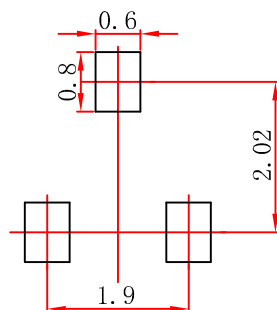

- Note:
1. Controlling dimension: in millimeters.
 2. General tolerance: $\pm 0.05\text{mm}$.
 3. The pad layout is for reference purposes only.