

### Description

The BTRD04A15 is a 15V bi-directional TVS diode, utilizing leading monolithic silicon technology to provide fast response time and low ESD clamping voltage, making this device an ideal solution for protecting voltage sensitive data and power line. The BTRD04A15 complies with the IEC 61000-4-2 (ESD) with  $\pm 30$  kV air and  $\pm 30$  kV contact discharge. It is assembled into an ultra-small 1.0x0.6mm lead-free DFN package. The small size and high ESD surge protection make BTRD04A15 an ideal choice to protect cell phone, digital cameras, audio players and many other portable applications.

### Features

- Ultra small package: 1.0x0.6x0.5mm
- Protects one data or power line
- Working voltage: 15V
- 2-pin leadless package
- Complies with following standards:
  - IEC 61000-4-2 (ESD) immunity test
    - Air discharge:  $\pm 30$  kV
    - Contact discharge:  $\pm 30$  kV
  - IEC 61000-4-5 (Lightning) 5A (8/20ns)
- RoHS Compliant

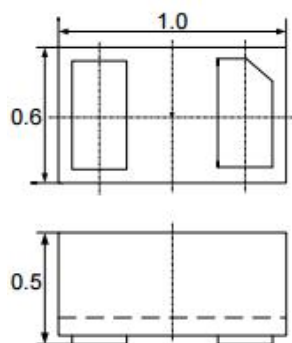
### Mechanical Characteristics

- Package: DFN1006-2 (1.0x0.6x0.5mm)
- Lead Finish: NiPdAu
- Case Material: “Green” Molding Compound.
- UL Flammability Classification Rating 94V-0
- Moisture Sensitivity: Level 3 per J-STD-020
- Terminal Connections: See Diagram Below
- Marking Information: See Below

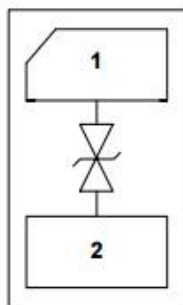
### Applications

- Cellular Handsets and Accessories
- Personal Digital Assistants
- Notebooks and Handhelds
- Portable Instrumentation
- Digital Cameras
- Peripherals
- Audio Players
- Industrial Equipment

### Dimensions & Symbol (Unit: mm Max)



Package Dimensions



Circuit and Pin Schematic

## Absolute Maximum Ratings ( $T_A=25^{\circ}\text{C}$ , RH=45%-75%, unless otherwise noted)

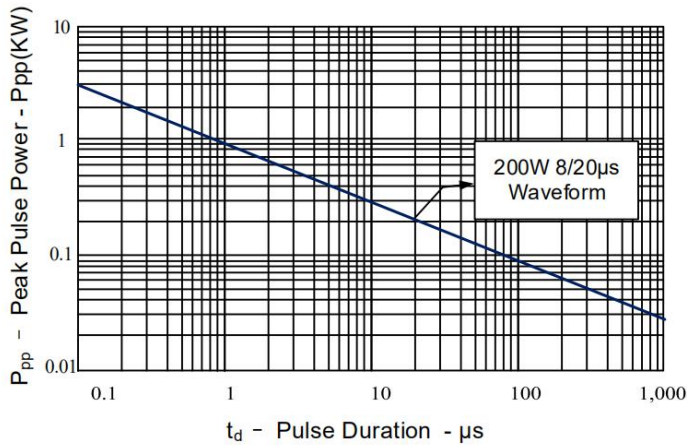
Parameter	Symbol	Value	Unit
Peak Pulse Power (tp=8/20 $\mu\text{s}$ waveform)	$P_{ppp}$	200	W
Peak Pulse Current (8/20 $\mu\text{s}$ )	$I_{pp}$	5	A
ESD per IEC 61000-4-2 (Air)	$V_{ESD}$	$\pm 30$	kV
ESD per IEC 61000-4-2 (Contact)		$\pm 30$	
Operating Temperature Range	$T_J$	-55 to +125	$^{\circ}\text{C}$
Storage Temperature Range	$T_{stg}$	-55 to +150	$^{\circ}\text{C}$

## Electrical Characteristics ( $T_A=25^{\circ}\text{C}$ )

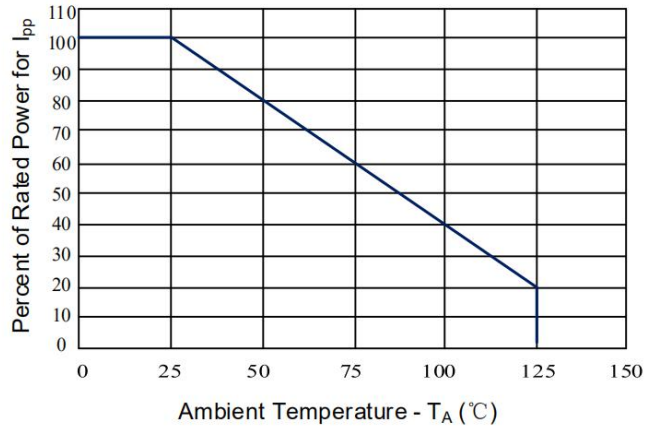
Parameter	Symbol	Min	Typ	Max	Unit	Test Condition
Reverse Working Voltage	$V_{RWM}$			15	V	
Breakdown Voltage	$V_{BR}$	16.7			V	$I_T = 1\text{mA}$
Reverse Leakage Current	$I_R$			0.2	$\mu\text{A}$	$V_{RWM} = 12\text{V}$
Clamping Voltage	$V_C$		20		V	$I_{PP} = 1\text{A}$ (8 x 20 $\mu\text{s}$ pulse)
Clamping Voltage	$V_C$		30	40	V	$I_{PP} = 5\text{A}$ (8 x 20 $\mu\text{s}$ pulse)
Junction Capacitance	$C_J$		15	20	pF	$V_R = 0\text{V}$ , $f = 1\text{MHz}$

Typical Performance Characteristics ( $T_A=25^{\circ}\text{C}$  unless otherwise Specified)

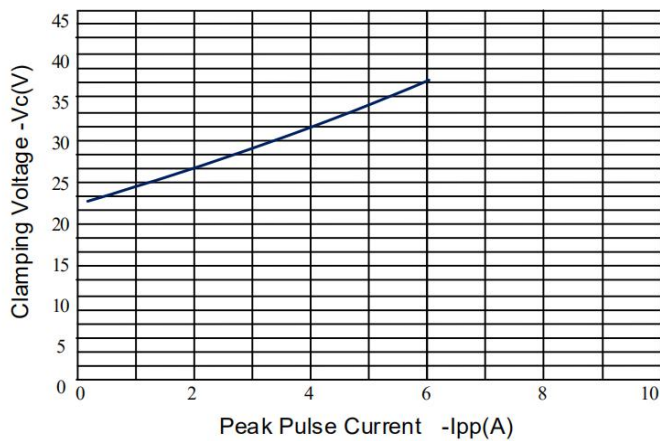
**Figure 1: Peak Pulse Power Vs Pulse Time**



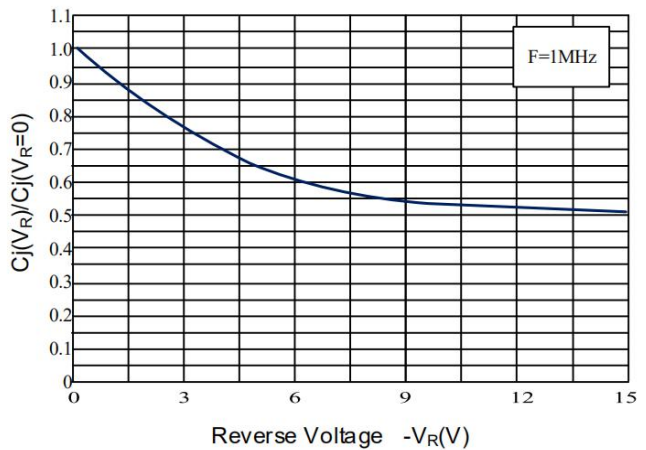
**Figure 2: Power Derating Curve**



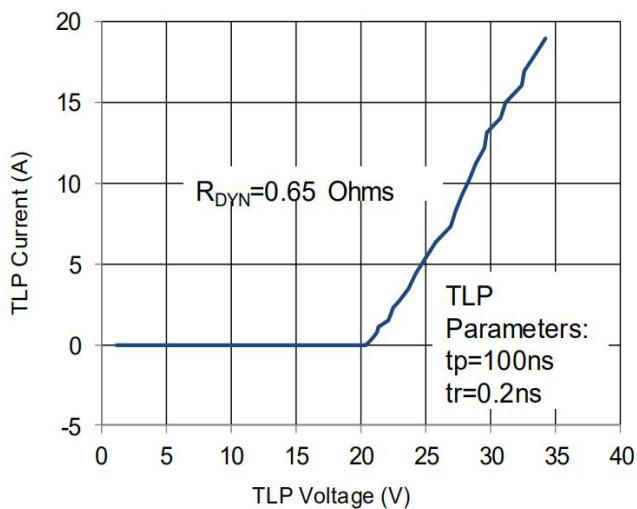
**Figure 3: Clamping Voltage vs. Peak Pulse Current**



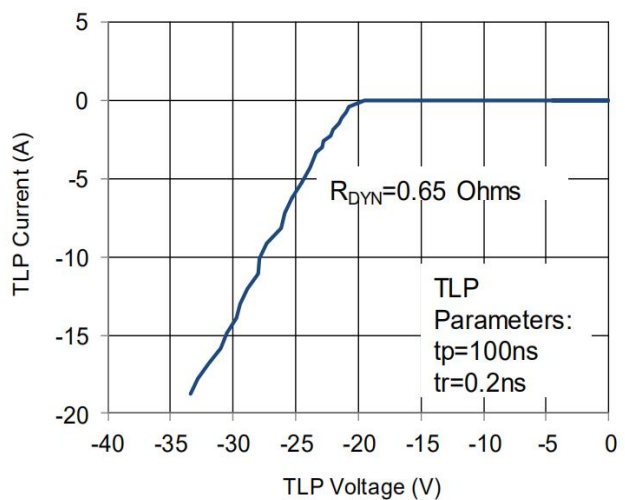
**Figure 4: Normalized Junction Capacitance vs. Reverse Voltage**



**Figure 5: TLP Positive I-V Curve**

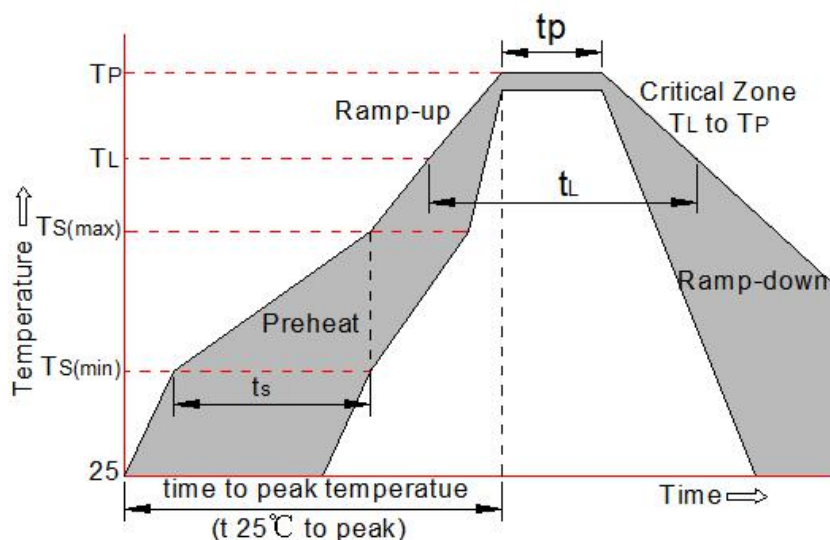


**Figure 6: TLP Negative I-V Curve**

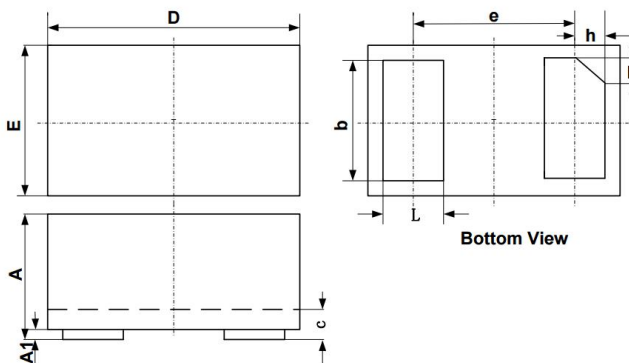


**Soldering Parameters**

Reflow Condition		Pb-Free assembly (see as bellow)
Pre Heat	-Temperature Min ( $T_{s(min)}$ )	+150°C
	-Temperature Max( $T_{s(max)}$ )	+200°C
	-Time (Min to Max) (ts)	60-180 secs.
Average ramp up rate (Liquid us Temp ( $T_L$ ) to peak)		3°C/sec. Max
$T_{s(max)}$ to $T_L$ - Ramp-up Rate		3°C/sec. Max
Reflow	-Temperature( $T_L$ ) (Liquid us)	+217°C
	-Temperature( $t_L$ )	60-150 secs.
Peak Temp ( $T_p$ )		+260(+0/-5)°C
Time within 5°C of actual Peak Temp ( $t_p$ )		30 secs. Max
Ramp-down Rate		6°C/sec. Max
Time 25°C to Peak Temp ( $T_p$ )		8 min. Max
Do not exceed		+260°C

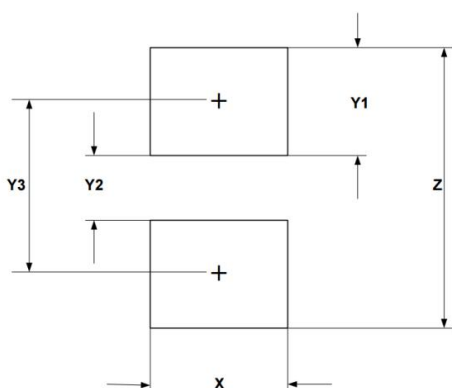


## Package Mechanical Data



SYM	DIMENSIONS					
	MILLIMETERS			INCHES		
	MIN	NOM	MAX	MIN	NOM	MAX
A	0.45	0.50	0.55	0.018	0.020	0.022
A1	0.00	0.02	0.05	0.000	0.001	0.002
b	0.45	0.50	0.55	0.018	0.020	0.022
c	0.12	0.15	0.18	0.005	0.006	0.007
D	0.95	1.00	1.05	0.037	0.039	0.041
e	0.65 BSC			0.026 BSC		
E	0.55	0.60	0.65	0.022	0.024	0.026
L	0.20	0.25	0.30	0.008	0.010	0.012
h	0.07	0.12	0.17	0.003	0.005	0.007

## Suggested Land Pattern



SYM	DIMENSIONS	
	MILLIMETERS	INCHES
X	0.60	0.024
Y1	0.50	0.020
Y2	0.30	0.012
Y3	0.80	0.032
Z	1.30	0.052