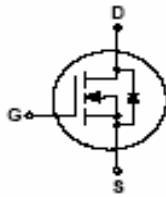
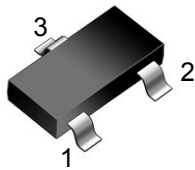

SOT-23

MARKING: S28

Features

Advanced trench process technology
 High density cell design for Ultra Low On-Resistance
 Halogen free and RoHS compliant

Mechanical Data

SOT-23 Small Outline Plastic Package
 EpoxyUL:94V-0

Maximum Ratings & Thermal Characteristics

(Ratings at 25°C ambient temperature unless otherwise specified.)

Symbol	Parameter	Rating	Unit	
V _{DS}	Drain-Source Breakdown Voltage	100	V	
V _{GS}	Gate-Source Voltage	±20	V	
T _J	Maximum Junction Temperature	150	°C	
T _{STG}	Storage Temperature Range	-50 to 155	°C	
I _S	Diode Continuous Forward Current	T _c =25°C	2	A
I _{DM}	Pulse Drain Current Tested	T _c =25°C	9	A
I _D	Continuous Drain Current@GS=10V	T _c =25°C	2	A
P _D	Maximum Power Dissipation	T _c =25°C	1.3	W
R _{θJA}	Thermal Resistance Junction-Ambient(([*] 1 in2 Pad of 2-oz Copper), Max.)	96	°C/W	

Electrical Characteristics

(Ratings at 25°C ambient temperature unless otherwise specified).

Symbol	Parameter	Condition	Min	Typ	Max	Unit
BV(BR) _{DSS}	Drain-Source Breakdown Voltage	V _{GS} =0V, I _D =250μA	100	--	--	V
I _{DSS}	Zero Gate Voltage Drain Current	V _{DS} =100V, V _{GS} =0V	--	--	1.0	μA
I _{GSS}	Gate-Body Leakage Current	V _{GS} =±20V, V _{DS} =0V	--	--	±100	nA
V _{GS(th)}	Gate Threshold Voltage	V _{DS} =V _{GS} , I _D =250μA	1.0	1.8	2.5	V
R _{DS(on)}	Drain-Source On-State Resistance	V _{GS} =10V, I _D =2A	--	250	280	mΩ
		V _{GS} =4.5V, I _D =1A	--	280	310	mΩ

Dynamic Electrical Characteristics

C _{iss}	Input Capacitance	V _{DS} =10V, V _{GS} =0V, f=1MHz	--	387	--	pF
C _{oss}	Output Capacitance		--	30	--	pF
C _{rss}	Reverse Transfer Capacitance		--	28	--	pF

Switching Characteristics

Q _g	Total Gate Charge	V _{DS} =50V, I _D =2A, V _{GS} =10V	--	9.5	--	nC
Q _{gs}	Gate Source Charge		--	1.8	--	nC
Q _{gd}	Gate Drain Charge		--	2	--	nC
t _{d(on)}	Turn-on Delay Time	V _{DS} =50V, I _D =1.3A, V _{GS} =10V, R _G =1Ω	--	4	--	nS
t _r	Turn-on Rise Time		--	17.5	--	nS
t _{d(off)}	Turn-Off Delay Time		--	13	--	nS
t _f	Turn-Off Fall Time		--	28	--	nS

Source- Drain Diode Characteristics

V _{SD}	Forward on voltage	T _j =25°C, I _s =2A,	--	--	1.2	V
-----------------	--------------------	---	----	----	-----	---

Ratings and Characteristic Curves

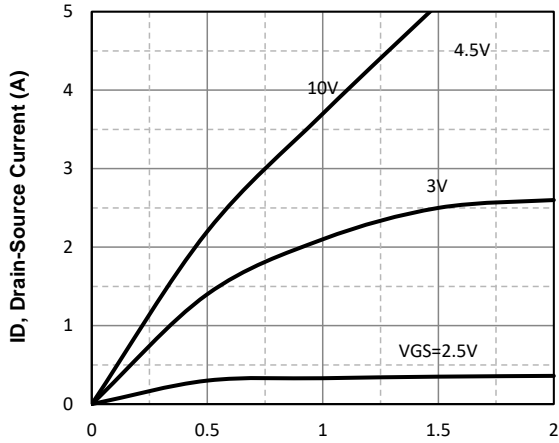

VDS, Drain -Source Voltage (V)
Fig1. Typical Output Characteristics

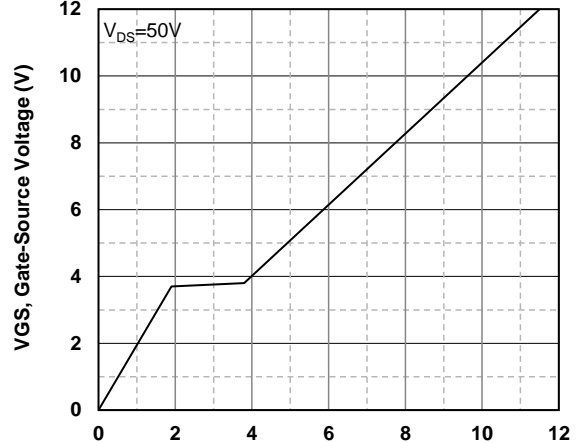

Qg -Total Gate Charge (nC)
Fig2. Typical Gate Charge Vs. Gate-Source Voltage

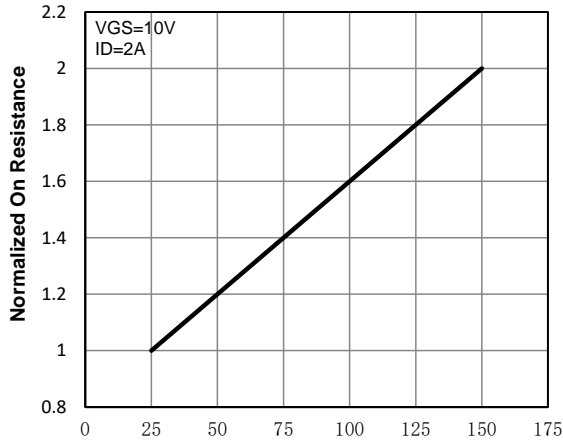

Tj - Junction Temperature (°C)
Fig3. Normalized On-Resistance Vs. Temperature

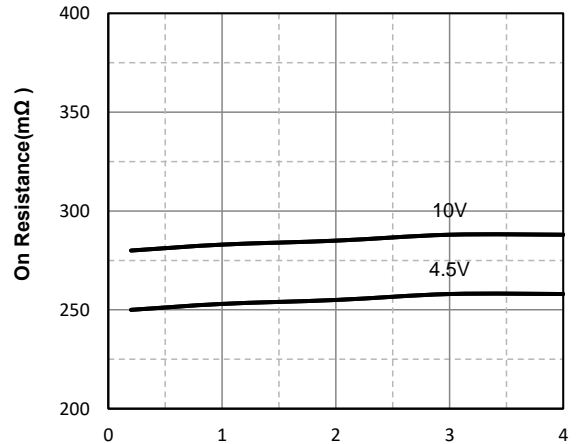

ID, Drain-Source Current (A)
Fig4. On-Resistance Vs. Drain-Source Current

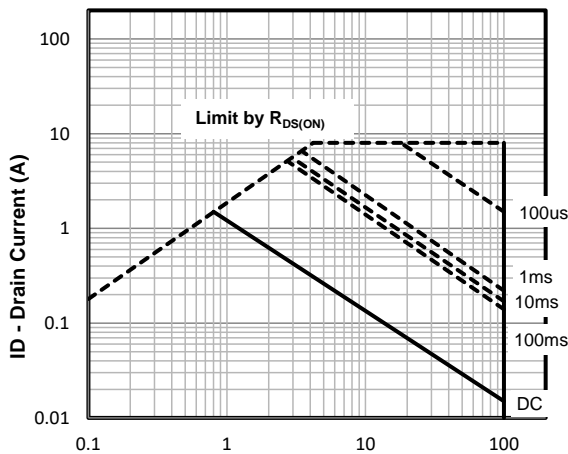

VDS, Drain -Source Voltage (V)
Fig5. Maximum Safe Operating Area

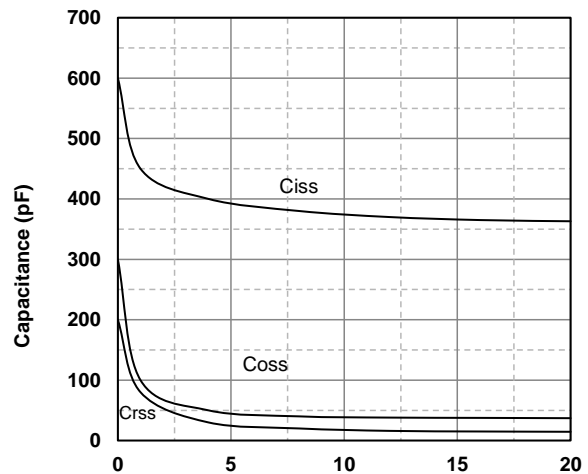

VDS, Drain-Source Voltage (V)
Fig6 Typical Capacitance Vs. Drain-Source Voltage

Summary of Packing Options

Package	Packing Description	Packing Quantity	Industry Standard
SOT-23	Tape/Reel,7" reel	3000	EIA-481-1

Package Outline Dimensions: SOT-23

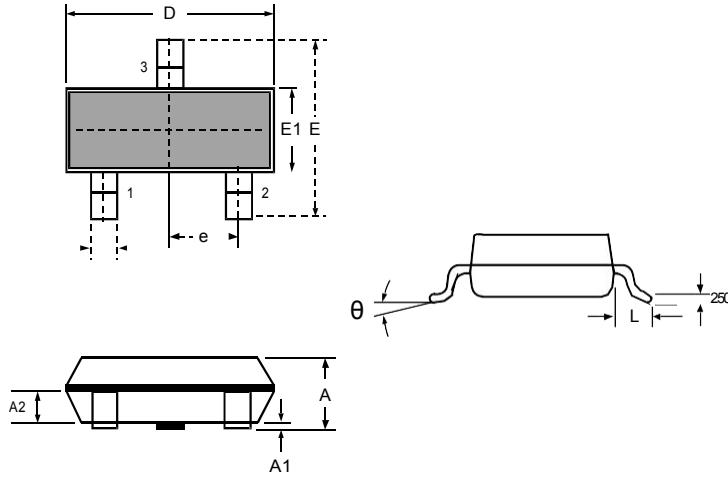

DIMENSIONS

SYMBOL	MILLIMETER		INCHES	
	MIN	MAX	MIN	MAX
A	0.900	1.150	0.035	0.045
A1	0.000	0.100	0.000	0.004
A2	0.900	1.050	0.035	0.041
D	2.800	3.000	0.110	0.118
b	0.300	0.500	0.012	0.020
E	2.250	2.550	0.089	0.100
E1	1.200	1.400	0.047	0.055
e	0.950 BSC		0.037 BSC	
L	0.300	0.500	0.012	0.020
θ	0	8°	0	8°