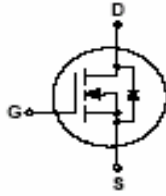
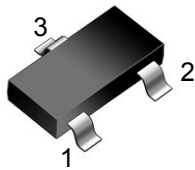

**SOT-23**

**MARKING:** R0

**Features**

Advanced trench process technology  
 High density cell design for Ultra Low On-Resistance  
 Halogen free and RoHS compliant

**Mechanical Data**

SOT-23 Small Outline Plastic Package  
 EpoxyUL:94V-0

**Maximum Ratings & Thermal Characteristics**

(Ratings at 25°C ambient temperature unless otherwise specified.)

Symbol	Parameter	Rating	Unit	
V <sub>DS</sub>	Drain-Source Breakdown Voltage	30	V	
V <sub>GS</sub>	Gate-Source Voltage	±12	V	
T <sub>J</sub>	Maximum Junction Temperature	150	°C	
T <sub>STG</sub>	Storage Temperature Range	-50 to 155	°C	
I <sub>S</sub>	Diode Continuous Forward Current	T <sub>c</sub> =25°C	5.8	A
I <sub>DM</sub>	Pulse Drain Current Tested	T <sub>c</sub> =25°C	23	A
I <sub>D</sub>	Continuous Drain Current@GS=10V	T <sub>c</sub> =25°C	5.8	A
P <sub>D</sub>	Maximum Power Dissipation	T <sub>c</sub> =25°C	1.2	W
R <sub>θJA</sub>	Thermal Resistance Junction-Ambient>(*1 in2 Pad of 2-oz Copper), Max.)	104	°C/W	

**Electrical Characteristics**

(Ratings at 25°C ambient temperature unless otherwise specified.)

Symbol	Parameter	Condition	Min	Typ	Max	Unit
BV(BR) <sub>DSS</sub>	Drain-Source Breakdown Voltage	V <sub>GS</sub> =0V, I <sub>D</sub> =250μA	30	--	--	V
I <sub>DSS</sub>	Zero Gate Voltage Drain Current	V <sub>DS</sub> =30V, V <sub>GS</sub> =0V	--	--	1	μA
I <sub>GSS</sub>	Gate-Body Leakage Current	V <sub>GS</sub> =±12V, V <sub>DS</sub> =0V	--	--	±100	nA
V <sub>GS(th)</sub>	Gate Threshold Voltage	V <sub>DS</sub> =V <sub>GS</sub> , I <sub>D</sub> =250μA	0.65	0.9	1.5	V
R <sub>DS(on)</sub>	Drain-Source On-State Resistance	V <sub>GS</sub> =10V, I <sub>D</sub> =5.8A	--	21	27	mΩ
		V <sub>GS</sub> =4.5V, I <sub>D</sub> =5.0A	--	27	33	
		V <sub>GS</sub> =2.5V, I <sub>D</sub> =4.0A	--	33	51	

**Dynamic Electrical Characteristics**

C <sub>ISS</sub>	Input Capacitance	V <sub>DS</sub> =15V, V <sub>GS</sub> =0V, f=1MHz	--	632	--	pF
C <sub>OSS</sub>	Output Capacitance		--	58	--	pF
C <sub>RSS</sub>	Reverse Transfer Capacitance		--	70	--	pF

**Switching Characteristics**

Q <sub>g</sub>	Total Gate Charge	V <sub>DS</sub> =15V, I <sub>D</sub> =5.8A, V <sub>GS</sub> =10V	--	17.3	--	nC
Q <sub>gs</sub>	Gate Source Charge		--	2.2	--	nC
Q <sub>gd</sub>	Gate Drain Charge		--	2.1	--	nC
t <sub>d(on)</sub>	Turn-on Delay Time	V <sub>DD</sub> =15V, I <sub>D</sub> =5.8A, V <sub>GS</sub> =10V, R <sub>G</sub> =3Ω	--	4.4	--	nS
t <sub>r</sub>	Turn-on Rise Time		--	28.3	--	nS
t <sub>d(off)</sub>	Turn-Off Delay Time		--	16.5	--	nS
t <sub>f</sub>	Turn-Off Fall Time		--	26.3	--	nS

**Source- Drain Diode Characteristics**

V <sub>SD</sub>	Forward on voltage	T <sub>j</sub> =25°C, I <sub>s</sub> =5.8A,	--	--	1.2	V
-----------------	--------------------	---	----	----	-----	---

# Ratings and Characteristic Curves

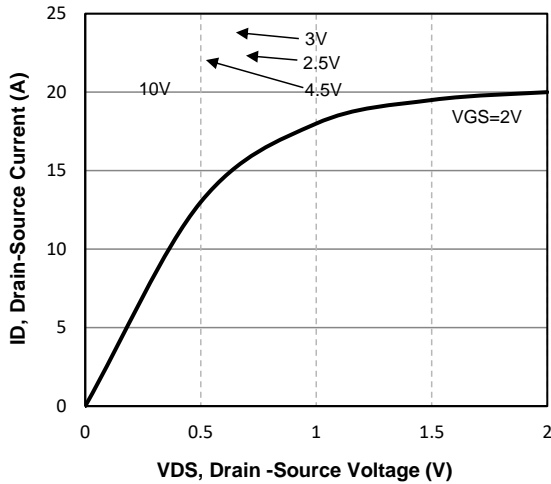

Fig1. Typical Output Characteristics

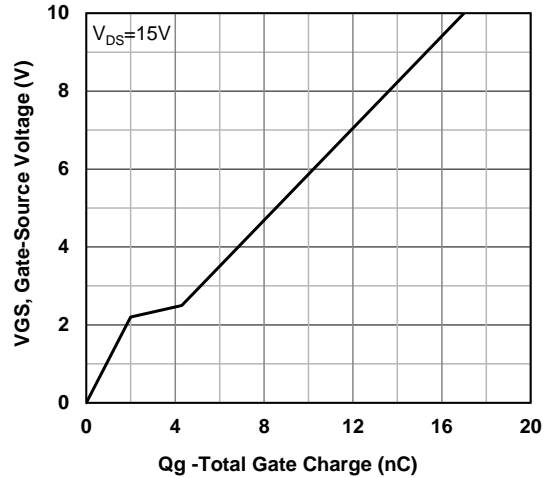

Fig2. Typical Gate Charge Vs. Gate-Source Voltage

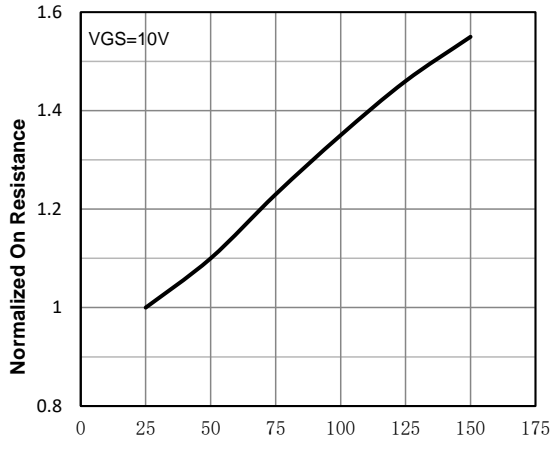

Fig3. Normalized On-Resistance Vs. Temperature

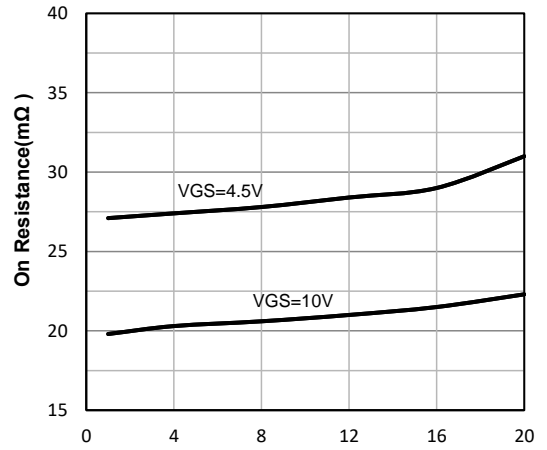

Fig4. On-Resistance Vs. Drain-Source

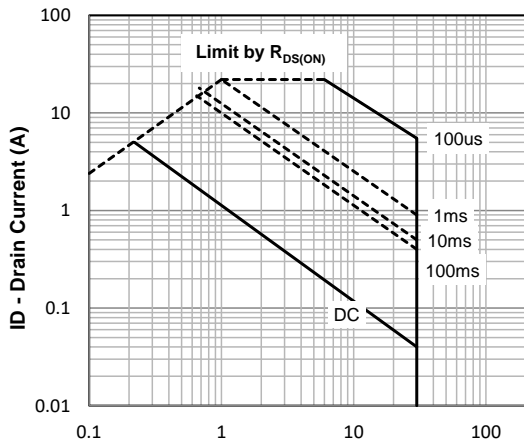

Fig5. Maximum Safe Operating Area

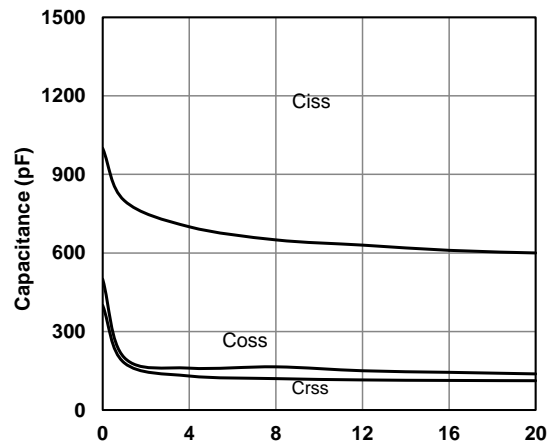
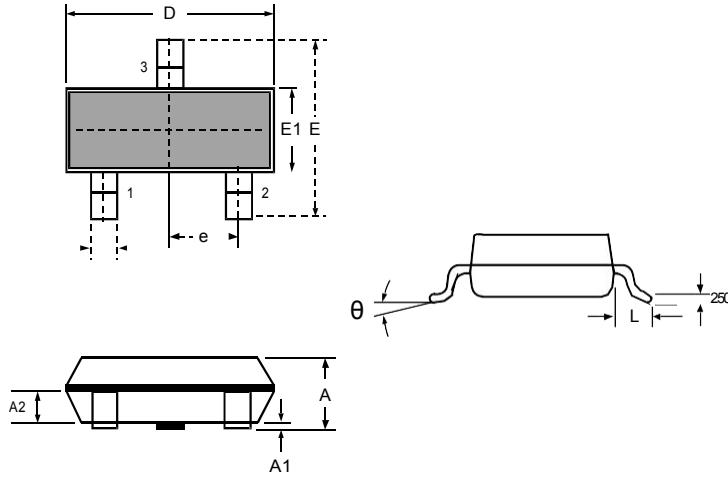

Fig6 Typical Capacitance Vs. Drain-Source Voltage

### Summary of Packing Options

Package	Packing Description	Packing Quantity	Industry Standard
SOT-23	Tape/Reel, 7" reel	3000	EIA-481-1

### Package Outline Dimensions: SOT-23



DIMENSIONS

SYMBOL	MILLIMETER		INCHES	
	MIN	MAX	MIN	MAX
A	0.900	1.150	0.035	0.045
A1	0.000	0.100	0.000	0.004
A2	0.900	1.050	0.035	0.041
D	2.800	3.000	0.110	0.118
b	0.300	0.500	0.012	0.020
E	2.250	2.550	0.089	0.100
E1	1.200	1.400	0.047	0.055
e	0.950 BSC		0.037 BSC	
L	0.300	0.500	0.012	0.020
θ	0	8°	0	8°