

- ◇ Low Forward Voltage Drop
- ◇ **SOD523** Micro SMD Package
- ◇ RoHS Compliant / Green EMC
- ◇ Matte Tin (Sn) Lead Finish
- ◇ Cathode Band / Device Marking
- ◇ Surface Mount Package Ideally Suited For Automatic Insertion

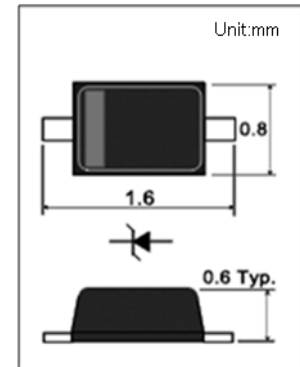

Maximum Ratings (Ta = 25 °C)

Symbol	Parameter	Value	Units
V_{RRM}	Peak Repetive Reverse Voltage	40	V
V_{RWM}	Working Peak Reverse Voltage	40	V
V_R	DC Blocking Voltage	40	V
$V_{R(RMS)}$	RMS Reverse Voltage	28	V
I_{FM}	Forward Continuous Current	350	mA
I_{FSM}	Non-Repetitive Peak Forward Surge Current (@t=8..3ms)	2.0	A
P_D	Power Dissipation	200	mW
T_J	Junction Temperature	125	°C
T_{STG}	Storage Temperature	-55 to +150	°C
$R_{\theta JA}$	Thermal Resistance From Junction To Ambient	625	°C/W

Electrical Characteristics (Ta = 25 °C)

Symbol	Parameter	Conditions	Min	Typ	Max	Units
V_{BR}	Reverse Voltage	$I_F = 100\mu A$	40			V
V_F	Forward Voltage	$I_F = 20mA$			0.37	V
		$I_F = 200mA$			0.60	V
I_R	Reverse current	$V_R = 30V$			5	μA
C_T	Capacitance	$V_R = 0V, f = 1MHz$			50	pF
t_{rr}	Typical Reverse Recovery Time	$I_F = I_R = 200mA,$ $I_{rr} = 0.1 * I_R, R_L = 100 \Omega$		10		ns

Curve Characteristics

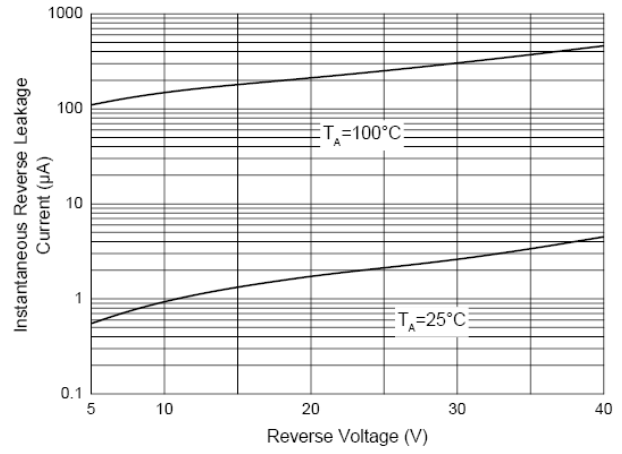
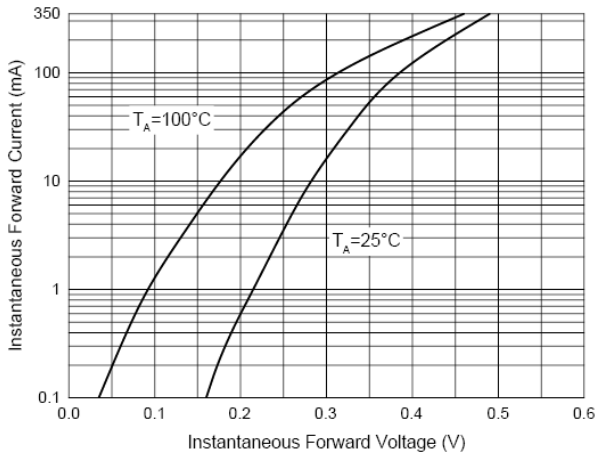

Typical Instantaneous Forward Characteristics

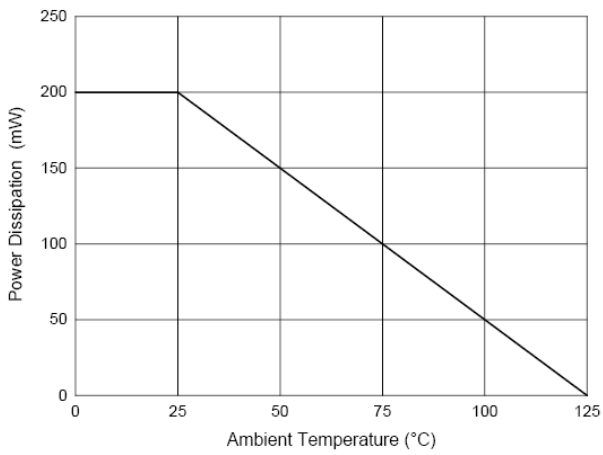

Typical Reverse Leakage Characteristics

Power Derating Curve

Package Dimensions

Package outline : SOD-523

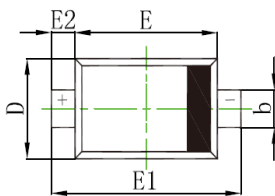
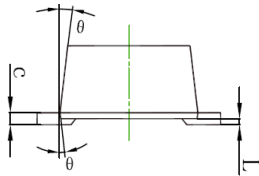

Unit	A	A1	b	c	D	E	E1	E2	L	theta
Max.	0.70	0.70	0.35	0.15	0.85	1.30	1.70	0.25	0.07	7° REF.
Min.	0.51	0.50	0.25	0.08	0.75	1.10	1.50	0.15	0.01	

SOD523Package Outline

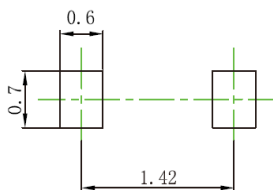

Land Pattern Recommendation

Note:

1. Halogen free,EMC
2. Pb free solder
3. Lead thickness includes solder plating
4. Lead frame: Cu
5. Other Tolerance: ± 0.05
6. Dimensions are exclusive of Burrs,Mold Flash and Tie Bar extrusions
7. Unit: mm