

CATEGORY	DESCRIPTION	P/N #
CONNECTOR	USB 2.0 AF DIP型沉板配.2	UB21F-XX11-HLRX22-X

REV.	ECON NO	DESCRIPTION	REVISED	DATE
A01	—	New Release	XSY	2019-8-8

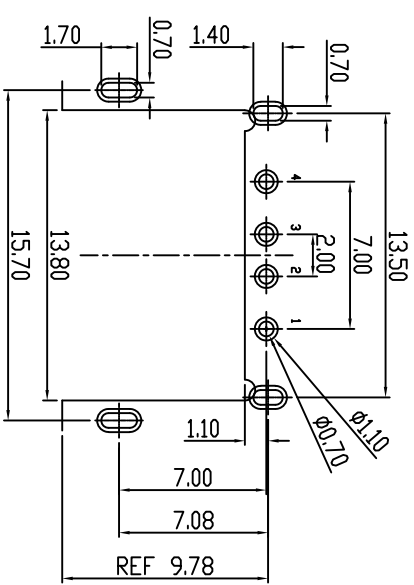

Tolerance: ±0.05 Thickness: 1.0~1.2mm
 Recommend PCB Layout
 (Top View)

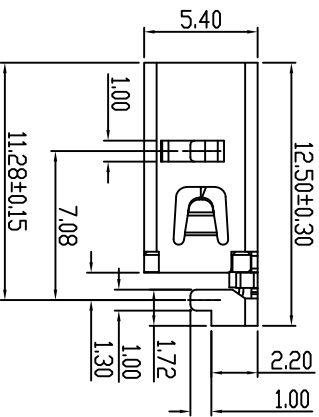
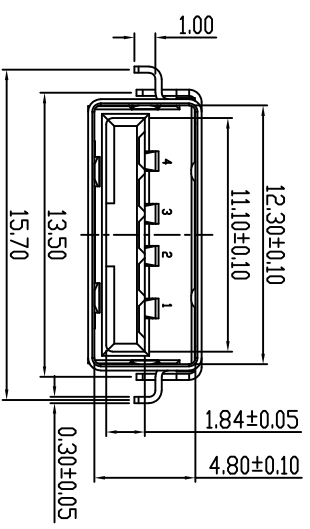
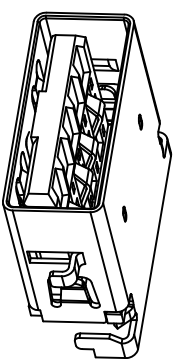
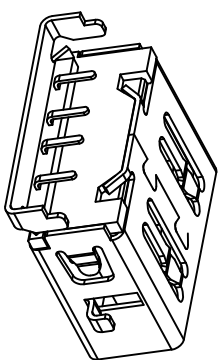
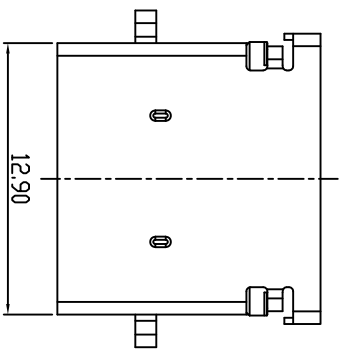
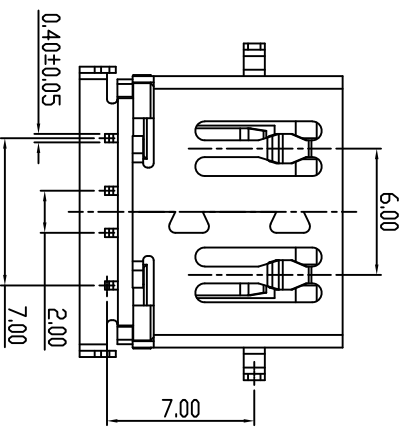

X	Housing Color
B	Black
U	Blue

X	包装方式
C	载带包装
P	吸塑包装

X	Terminal Plating
0	Au 1u" Plating
1	Au 3u" Plating
2	Au 6u" Plating
3	Au 15u" Plating

X	Shell Material
G	SUS
B	Copper Alloy
S	SPCC

UB21F-XX11-HLRX22-X

c	Shell	1	See Table T=0.3mm	Ni Plating
b	Terminal	4	Copper Alloy T=0.2mm	See Table
a	Housing	1	LCP UL94V-0	See Table
NO.	PART NAME	QTY	MATERIAL	PLATING & COLOR

UNLESS OTHERWISE SPECIFIED TOLERANCES

SCALE: 1/1 UNIT: mm DWG.NO:

 东莞市合陵电子有限公司
 Dongguan Heling Electronic Co., LTD

DECIMALS:	ANGLES:	APPROVED BY	CHECKED BY	PREPARED BY
X : ±0.5	X : ±2°	Tony	XSY	XSY
XX : ±0.3	XX : ±1°			
XXX : ±0.2				

2. MECHANICAL CHARACTERISTICS

- 2-1: UNMATING FORCE: 10N MIN INITIAL; 8N MIN AFTER TEST.
- 2-2: MATING FORCE: 35N MAX;
- 2-3: DURABILITY: 1500 CYCLES;

1. Electrical Characteristics

- 1-1: Rate Voltage: 30V DC
- 1-2: Current Rating: 1.5A
- 1-3: Contact Resistance: 30mΩ MAX.
- 1-4: Insulation Resistance: 100MΩ MIN.
- 1-5: Dielectric Withstand Voltage :500V R.M.S
- 1-6: Operature Temperature: -40°C~85°C