

CATEGORY	DESCRIPTION	P/N #
CONNECTOR	RU11 6P2C 2x2 DIP 带弹无灯	MJ5962B-BX22-HPRDS1

REV.	ECN NO	DESCRIPTION	REVISED	DATE
A01		New Release	YST	2020.09.05

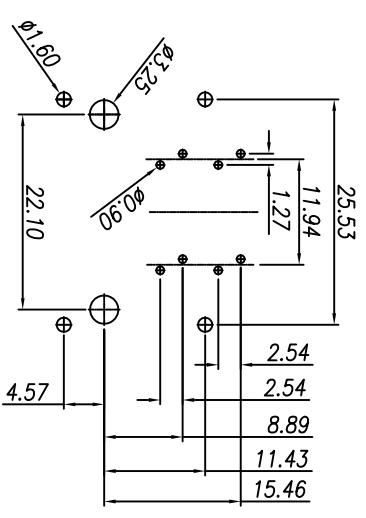
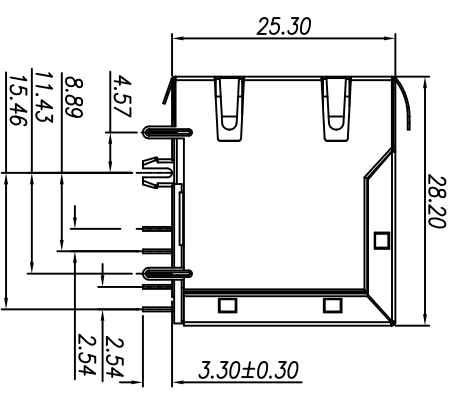
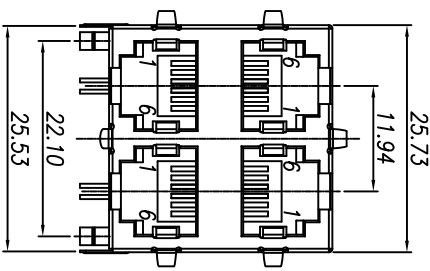
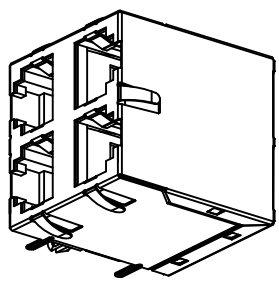
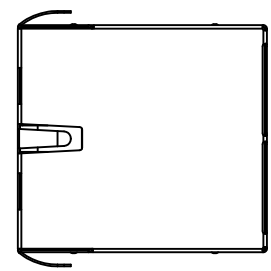

MJ5962B-BX22-HPRDS1

PC BOARD COMPONENT SIDE SHOWN

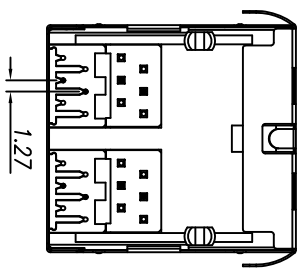

X	Terminal Plating
0	G/F Plating
1	Au 3u" Plating
2	Au 6u" Plating
3	Au 15u" Plating
4	Au 30u" Plating

- SPECIFICATIONS:
1. R_U Electrical Characteristics
 - 1-1: Voltage: 150V AC RMS
 - 1-2: Current Rating: 1.5A
 - 1-3: Contact Resistance: 40mΩ MAX.
 - 1-4: Insulation Resistance: 500MΩ MIN.
 - 1-5: Dielectric Withstand Voltage :1000V AC
 - 1-6: Operature Temperature: -40°C~80°C

d	Shielding	1	Brass, T=0.2mm	Ni Plating
c	Terminal	8	Phosphor Bronze, Ø0.46	Au Plating
b	Insert	4	PBT U.94V-0	Black
a	Housing	1	PBT U.94V-0	Black
NO.	PART NAME	Q'TY	MATERIAL	PLATING & COLOR

UNLESS OTHERWISE SPECIFIED TOLERANCES

DECIMALS:	ANGLES:
X : ±0.5	X : ±2°
X.X : ±0.3	X.X : ±1°
X.XX : ±0.2	

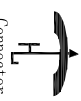
 东莞市合陵电子有限公司
 Dongguan Heling Electronic Co.,LTD
 Connector

SCALE: 1/1	UNIT: mm	DWG.NO:
SIZE: A3	PAGE: 1 OF 1	REV: A01
APPROVED BY	CHECKED BY	PREPARED BY
DICK	XSY	YST

CUSTOMER COPY