

GT-TC101B-H145-L1

G-Switch

Operating Force

- A=160gf
- B=250gf
- C=100gf
- D=360gf

Switch Lifetime (Force)

- L05=50,000 Cycles
- L1=100,000 Cycles
- L3=300,000 Cycles
- L5=500,000 Cycles

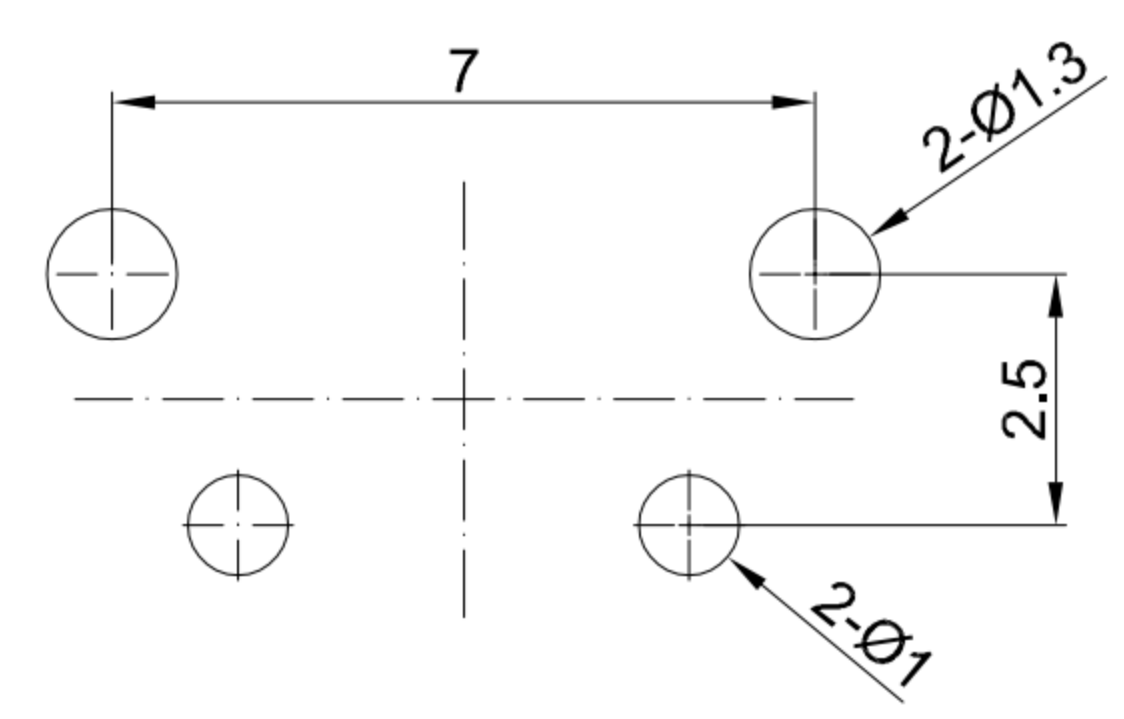
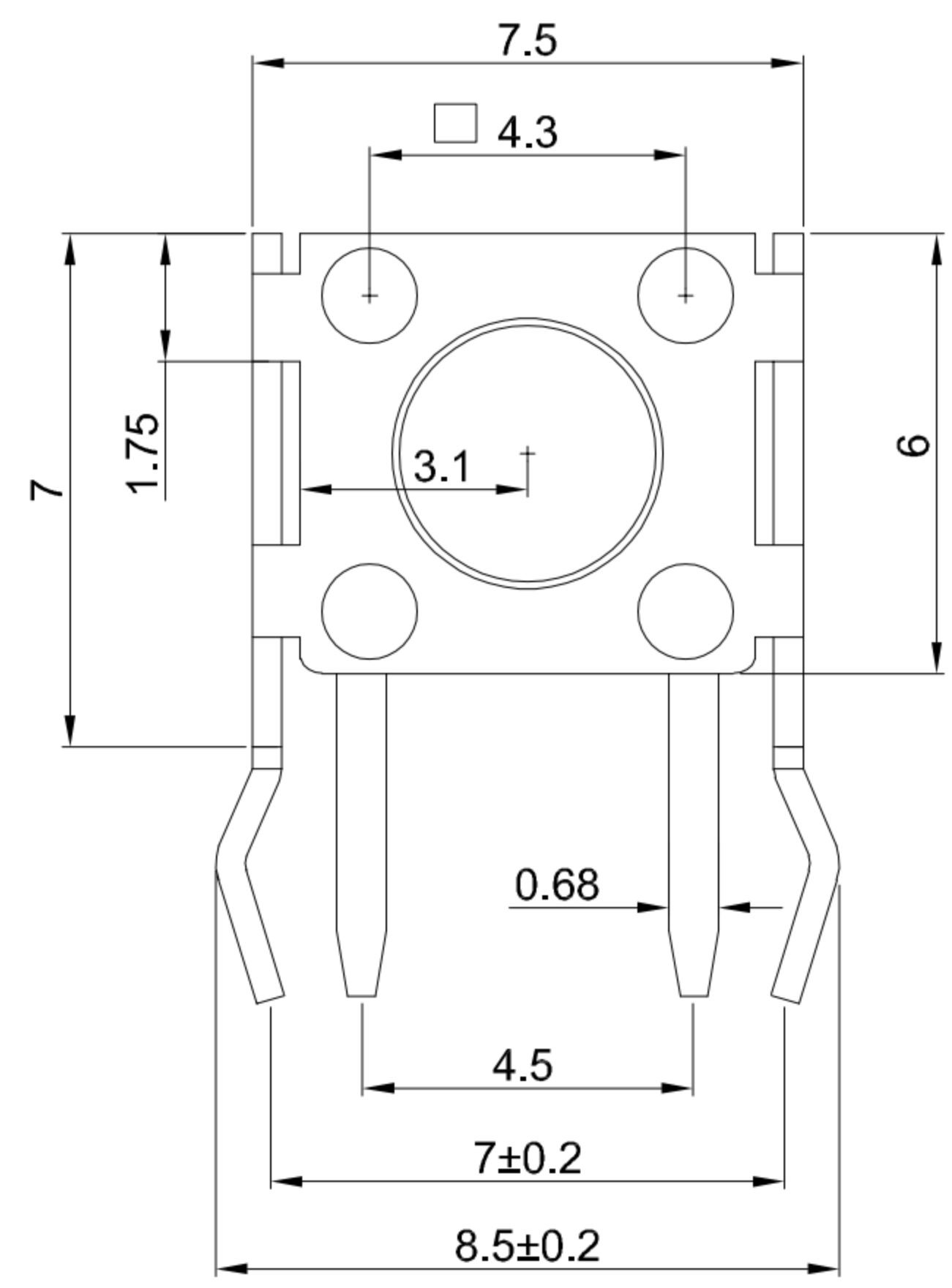

RECOMMENDED PCB LAYOUT
TOLERANCE: ±0.05

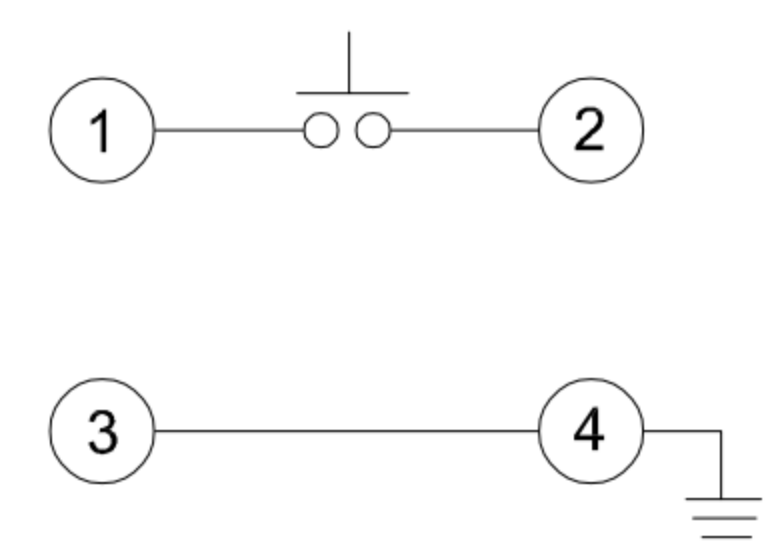

CIRCUIT DIAGRAM

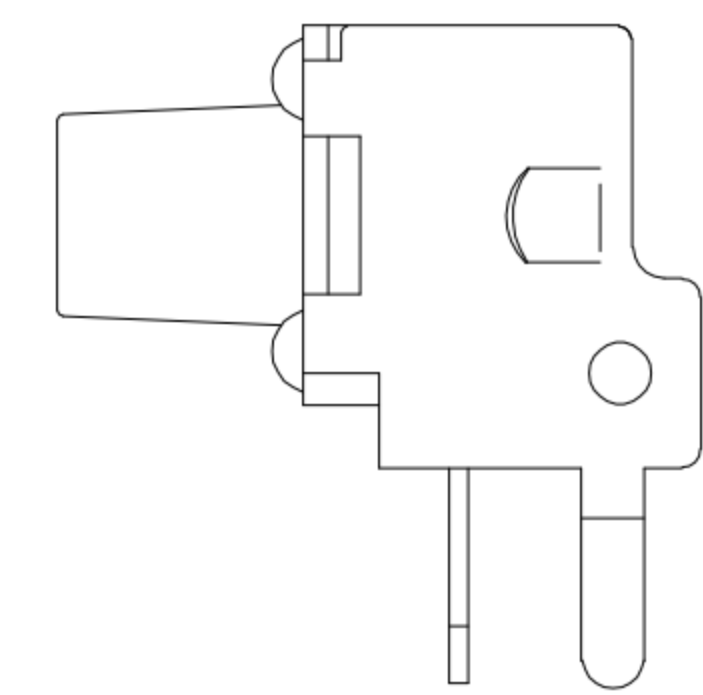

Switch Height

- H043=4.3mm
- H055=5.5mm
- H065=6.5mm
- H075=7.5mm
- H085=8.5mm
- H095=9.5mm
- H105=10.5mm
- H115=11.5mm
- H125=12.5mm
- H135=13.5mm
- H145=14.5mm
- H155=15.5mm
- H165=16.5mm
- H175=17.5mm
- H185=18.5mm
- H050=5.0mm
- H060=6.0mm
- H070=7.0mm
- H080=8.0mm
- H090=9.0mm
- H100=10.0mm
- H110=11.0mm
- H120=12.0mm
- H130=13.0mm
- H140=14.0mm
- H150=15.0mm
- H160=16.0mm
- H170=17.0mm
- H180=18.0mm
- H190=19.0mm

G-Switch Specification:

1. Operating temperature range: -40°C ~ +85°C
2. Rating: 50mA, 12V DC
3. Insulation resistance: 100MΩ min, 100V DC
4. Dielectric strength: 250V AC for 1 min
5. Contact resistance: 100mΩ max.
6. Travel: 0.25±0.1mm

NO.	PART NAME	MATERIAL	REMARK
5	TERMINAL	BRASS	Ag PLATING
4	BASE	PPA	BLACK
3	CONTACT	STAINLESS STEEL	Ag PLATING
2	COVER	STAINLESS STEEL	Cu/Sn
1	STEM	PPA	BLACK



SCALE: 1:1	UNIT: mm
SIZE: A4	
Unless otherwise General Tolerance:	
X.	±0.20
X.x	±0.15
X.xx	±0.05
X°	±2°

Title: Horizontal Tact Switch Support DIP CH=4.0mm 7.5×6.0×14.5mm			
Molde Code: GT-TC101B-H145-L1			
DRAWN	CHECKED	APPROVED	DATE
Xia	Chen	Chen	2023.02.01



REV: A0	SHEET: 1/1
---------	------------