



# 深圳市怡远科技有限公司

SHENZHEN YIYUAN TECHNOLOGY CO., LTD

产品名称Product: FFC排线 A面（同面）

产品型号Part No: YTC05A-NP-L-3-4

广东省深圳市南山区粤海街道高新区社区高新南一道016号联想大厦东3F  
3F East, #16, Gaoxin South 1 Street, Hi-Tech Park, Nanshan District, Shenzhen City

电话/Tel: 86-0755-82784562 [Http://www.yiyuanswitches.com](http://www.yiyuanswitches.com)



# MATERIAL SPECIFICATION

PRODUCT	FLEXIBLE FLAT CABLE					
UL STYLE NO.	VOLTAGE RATING	OPERATING TEMPERATURE	UL FILE NO.	MARKING		
<input type="checkbox"/> AWM 2896	30V	80°C		AWM 2896 80°C VW-1		
<input checked="" type="checkbox"/> AWM 20624	60V	80°C		AWM 20624 80°C VW-1		
<input type="checkbox"/> AWM 20706	60V	105°C		AWM 20706 105°C VW-1		
CONDUCTOR	SIZE (Ct×Cw)	RATED CURRENT	RESISTANCE	REMARKS		
	<input type="checkbox"/> 0.1X1.27	2A	0.17Ω/M	* TIN PLATED COPPER WIRE		
	<input type="checkbox"/> 0.1X0.8	2A	0.27Ω/M	:99.994% PURE COPPER		
	<input type="checkbox"/> 0.1X0.7	2A	0.33Ω/M	* TOLERANCE OF THICKNESS		
	<input type="checkbox"/> 0.1X0.65	2A	0.35Ω/M	:±0.005		
	<input type="checkbox"/> 0.1X0.5	1A	0.42Ω/M	* TOLERANCE OF WIDTH		
	<input type="checkbox"/> 0.1X0.3	1A	0.70Ω/M	:±0.03		
	<input type="checkbox"/> 0.05X0.8	1A	0.53Ω/M	* EXTENSION RATE		
	<input type="checkbox"/> 0.05X0.65	1A	0.63Ω/M	:OVER THAN 15%		
	<input type="checkbox"/> 0.05X0.6	1A	0.65Ω/M	* STRAIN STRENGTH		
	<input type="checkbox"/> 0.035X0.8	1A	0.83Ω/M	:OVER THAN 13Kgf/mm <sup>2</sup>		
	<input type="checkbox"/> 0.035X0.7	1A	0.60Ω/M	* PLATING THICKNESS		
	<input type="checkbox"/> 0.035X0.6	1A	0.96Ω/M	:0.075 μ 以上		
	<input type="checkbox"/> 0.035X0.3	0.5A	1.80Ω/M			
	<input checked="" type="checkbox"/> 0.035X0.3	0.5	1.89Ω/M			
<input type="checkbox"/> 0.022X0.3	0.5A	3.18Ω/M				
<input type="checkbox"/> 0.1X0.5(P)	0.5A	2.80Ω/M	* TIN PLATED PHOSPHORUS BRONZE WIRE			
LEAD FREE <input checked="" type="checkbox"/>			G <input type="checkbox"/> D			
INSULATION FILM	NO.	BASE FILM	ADHESIVE	TOTAL THICKNESS	REMARK	COLOR
	<input type="checkbox"/> 1	PET 25μm	35μm	60μm	REGULAR	<input type="checkbox"/> WHITE <input type="checkbox"/> BLACK
	<input checked="" type="checkbox"/> 2	PET 19μm	24μm	43μm	SUPER FLEX	<input checked="" type="checkbox"/> WHITE
	<input type="checkbox"/> 3	PET 12μm	25μm	37μm	ULTRA FLEX	<input type="checkbox"/> WHITE
DECA FREE <input type="checkbox"/>						
SUPPORTING TAPE	NO.	BASE FILM	ADHESIVE	TOTAL THICKNESS	COLOR	
	<input type="checkbox"/> 1	PET 125μm	35μm	160μm	<input type="checkbox"/> WHITE	<input type="checkbox"/> BLUE
	<input checked="" type="checkbox"/> 2	PET 190μm	35μm	225μm	<input type="checkbox"/> WHITE	<input checked="" type="checkbox"/> BLUE
	<input type="checkbox"/> 3	PET 215μm	35μm	250μm	<input type="checkbox"/> WHITE	<input type="checkbox"/> BLUE
	<input type="checkbox"/> 4	PET 250μm	35μm	285μm	<input type="checkbox"/> WHITE	<input type="checkbox"/> BLUE
EMI SHIELD	ALUMINIUM FOIL [    μm]    COPPER FOIL [    μm]    FABRIC TAPE [    μm]    LAMINATION [    ]					
DOUBLE SIDE TAPE						
DIELECTRIC VOLTAGE WITHSTAND TEST			AC 500V/10mA 1分钟			
INSULATION RESISTANCE TEST			DC 500V/100Ω/M			
AGING			85°C/96 HR			
FLEXIBILITY	GENERAL	10,000 Min (R5×240/Min×40mm/Reciprocating)				
	FLEX	100,000 Min (R5×240/Min×40mm/Reciprocating)				
	SUPER	3,000,000 Min (R5×240/Min×40mm/Reciprocating)				
	ULTRA	6,000,000 Min (R5×240/Min×40mm/Reciprocating)				
FLAMMABILITY		PASS UL VW-1				

## Matters that demand special attention :

- \* When insert to connector, please insert straight correctly with Joiner's supporting-tape.

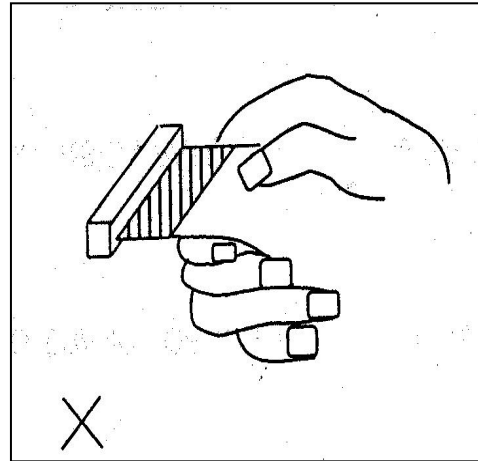
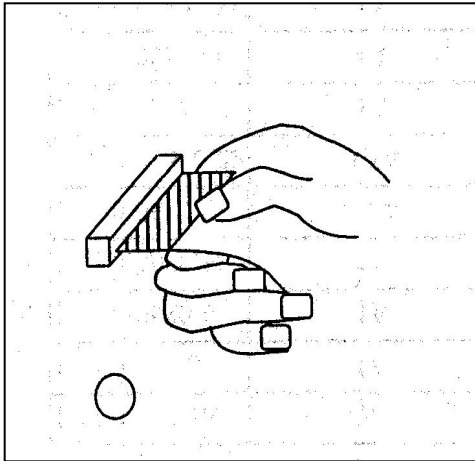

- \* When insert to connector, please avoid excessive force.

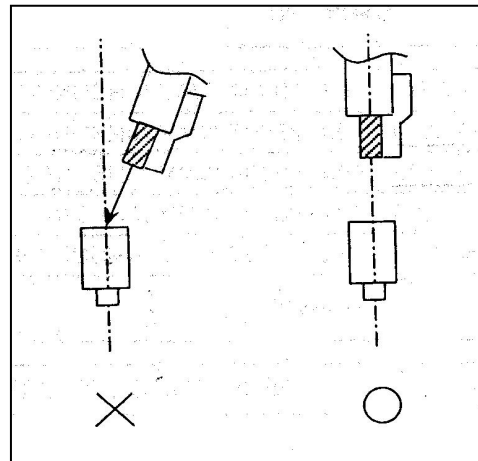
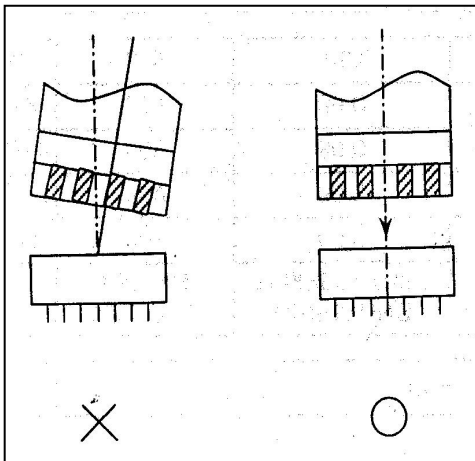

- \* After insert to connector, shall be not bend at supporting-tape excessive because Joiner is broken

