

»Features

- Low forward voltage drop
- High current capability
- High reliability
- High surge current capability
- Epitaxial construction



»General Description

- Case: molded plastic
- Polarity: Color band denotes cathode
- Package: SOT-23 Plastic Package

»Circuit and Marking

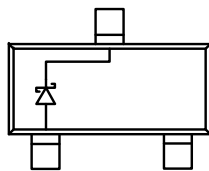

BAS70: 73

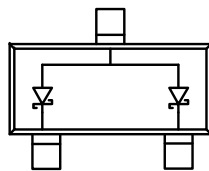

BAS70-06:76

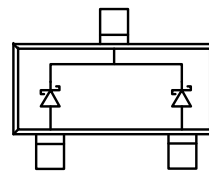

BAS70-05: 75

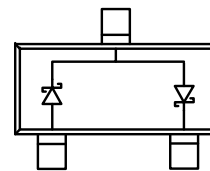

BAS70-04:74

» Maximum Ratings @ $T_A=25^{\circ}\text{C}$ unless otherwise noted

Symbol	Parameter	Value	Unit
VRRM VRWM VR	Peak Repetitive Peak Reverse Voltage Working Peak Reverse Voltage DC Blocking Voltage	70	V
IFM	Forward Continuous Current	70	mA
IFSM	Non-repetitive Peak Forward Surge Current@8.3mS	100	mA
Pd	Power Dissipation	200	mW
RθJA	Thermal Resistance From Junction To Ambient	450	°C/W
TJ	Operation Junction Temperature Range	-40~+125	°C
TSTG	Storage Temperature Range	-55~+150	°C

» **Electrical Characteristics** @ $T_A=25^\circ\text{C}$ unless otherwise noted

Symbol	Parameter	Test conditions	Min	Max	Unit
V(BR)	Reverse breakdown voltage	$I_R=10\mu\text{A}$	70		V
I_R	Reverse current	$V_R=50\text{V}$		100	nA
VF	Forward voltage	$I_F=1\text{mA}$		410	mV
		$I_F=15\text{mA}$		1000	mV
CD	Diode capacitance	$V_R=0\text{V}, f=1\text{MHz}$		2	pF
t_{rr}	Reverse recovery time	$I_F=I_R=10\text{mA}, I_{rr}=1\text{mA}, R_L=100\Omega$		5	nS

» **Typical Performance Characteristics** ($T_J = 25^\circ\text{C}$, unless otherwise noted)

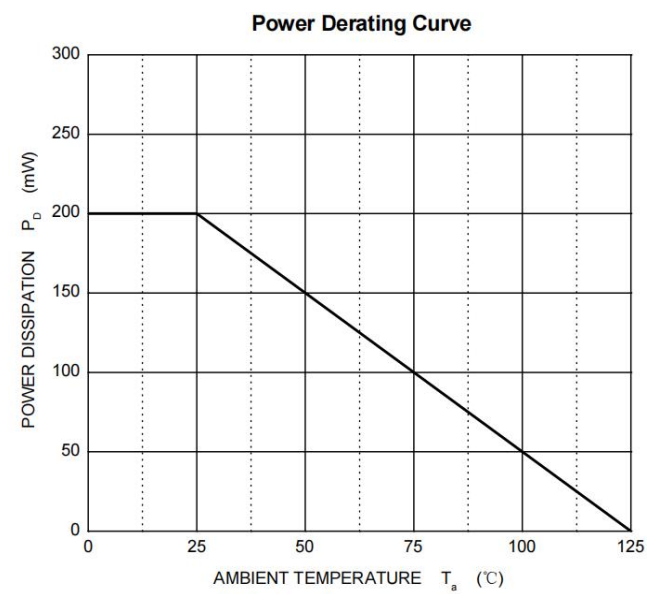
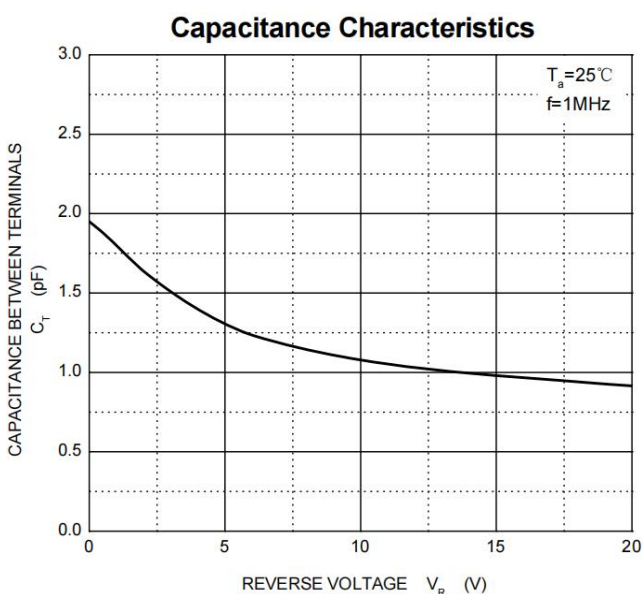
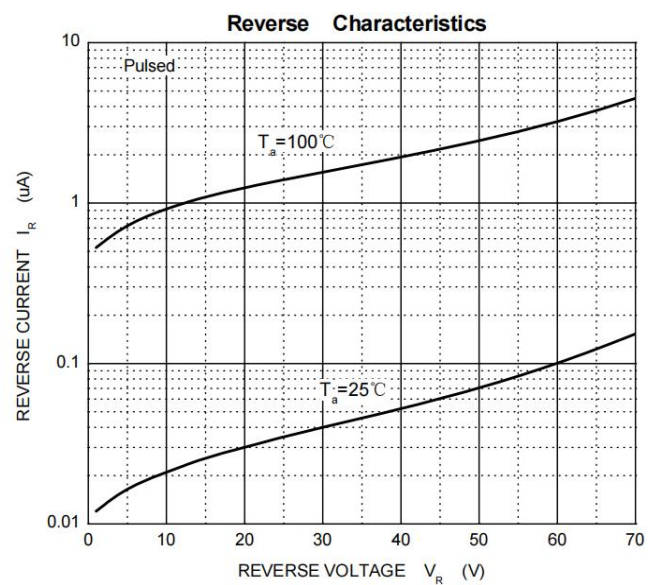
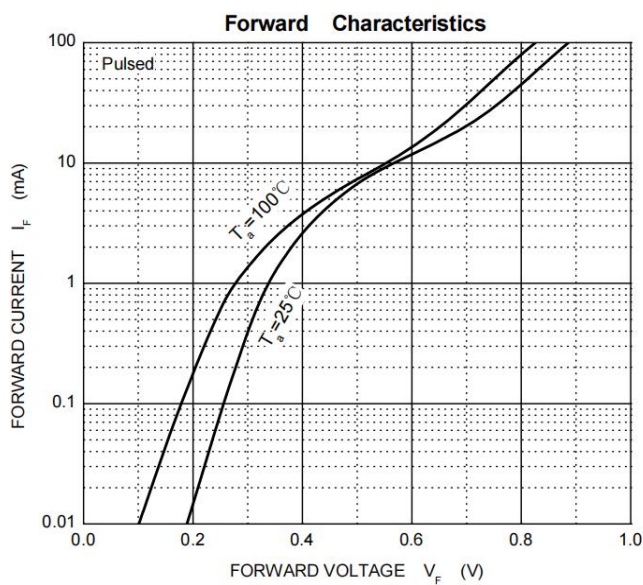

»Package Information SOT-23

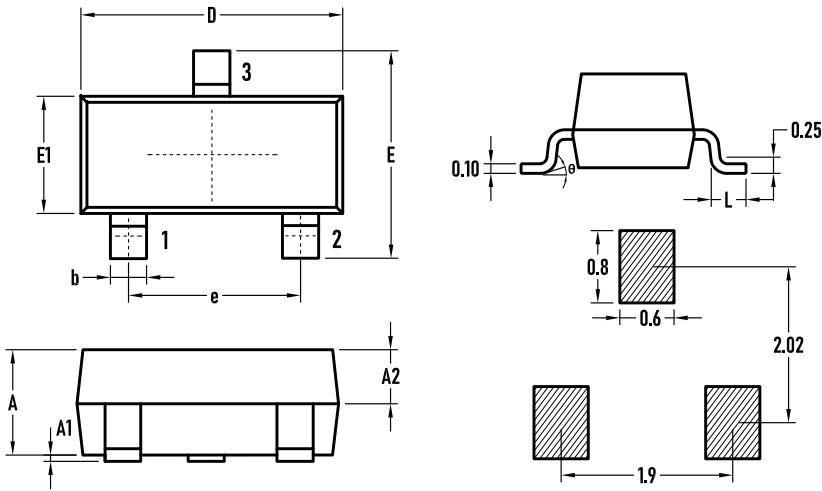

SYMBOL	MILLIMETER		
	MIN.	Typ	MAX
A	0.90	1.00	1.10
A1	0.02	0.06	0.10
A2	–	0.60	–
D	2.85	2.90	2.95
b	0.37	0.40	0.43
E	2.35	2.40	2.45
E1	1.25	1.30	1.35
e	1.85	1.90	1.95
L	0.35	0.40	0.48
θ	0	–	6°

»Ordering information

Order code	Package	Base qty	Delivery mode
BAS70/-04/-05/-06	SOT-23	3K	Tape and reel