

**NEW**



0.4mm Pitch, Stacking Type  
Board-to-board Connector

CONNECTOR

MB-0277-1

March 2014

## WP6C Series

**RoHS Compliant**

Plug

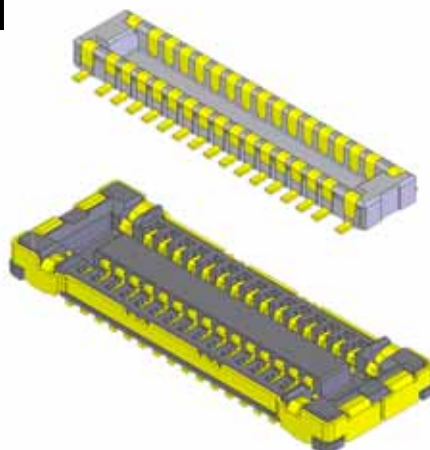

Receptacle

The WP6C Series is a low-profile stacking type board-to-board (FPC) connector with 0.4mm pitch spacing that is ideal for high-density mounting in slim information communication devices like mobile phones, smartphones, LCD, and notebook PC.

The WP6C Series has a shield structure that reduces noise during mating with a secure ground connection with its exclusive terminals on the four corners and with a shield equipped on the rear side of receptacle .

Also, the mounting pattern of the WP6C Series are the same as the existing WP6 Series. Both types with and without shield are available.

### Features

0.4mm pitch, 2 rows, stacking height 0.8mm.

Contact structure ensures high wear-resistance and high contact reliability.

Secure hold-downs prevent insulator breakage and peeling from FPC.

2-point contact design to resist twisting stress.

Enhanced ground connection during mating, and shield structure with anti-noise measure.

Pb-free. Ni barrier on contact prevents solder wicking.

\* The mounting pattern is the same as the existing WP6 Series. (Not mateable)

### General Specifications

No. of Contacts: 24, 30

Pitch: 0.4mm, 2 rows

Operating Temperature:

-40 Deg. C ~ +85 Deg. C

Contact Resistance: 70mΩ max. (initial)

Durability: 30 times

Rated Current: AC, DC each 0.3A / per 1 pos.

Rated Voltage: AC, DC 50V

Insulation Resistance: 100MΩ min. (initial)

Dielectric Withstanding Voltage:  
AC250Vr.m.s., for 1 minute

Total Insertion Force: 1.5N x n max. (n: No. of pos.)

Total Extraction Force: 0.15N x n min. (n: No. of pos.)

Materials and Finishes

Component	Material and Finish
Contact	(Contacting area) Copper alloy / Au plating (0.1µm min.) (Mounting area) Copper alloy / Au plating (0.05µm min.)
Insulator	Heat Resistant Plastic
Ground Contact	Plug Side: Copper alloy / Au flash plating
Shell	Receptacle Side: Copper alloy / Au flash plating

Ordering Information (Plug)

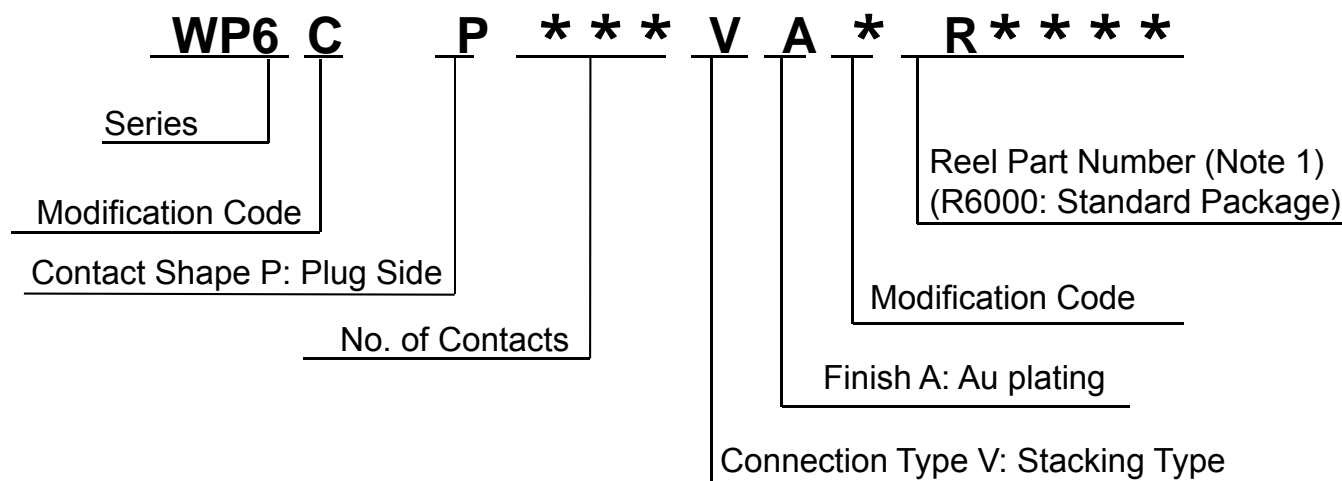

Ordering Information (Receptacle)

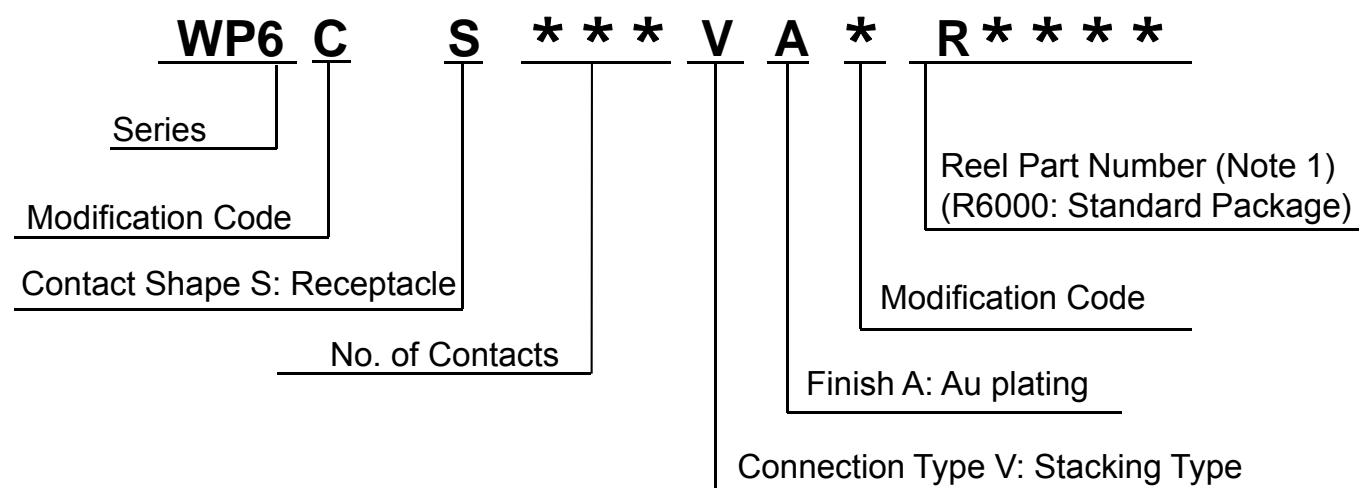

Note 1) An embossed tape reel contains 6,000 pieces of standard product. Please contact us for details on embossed tape specifications.

Part Number	WP6C-P***VA1
SJ Drawing	SJ112897

# WP6C Plug

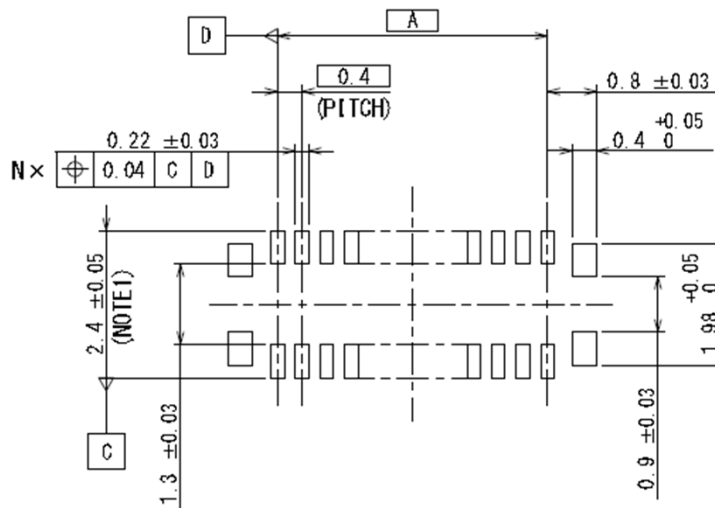
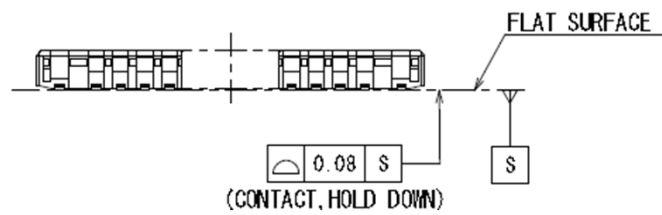
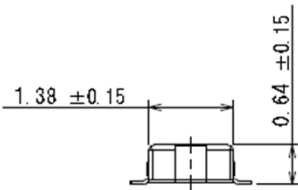
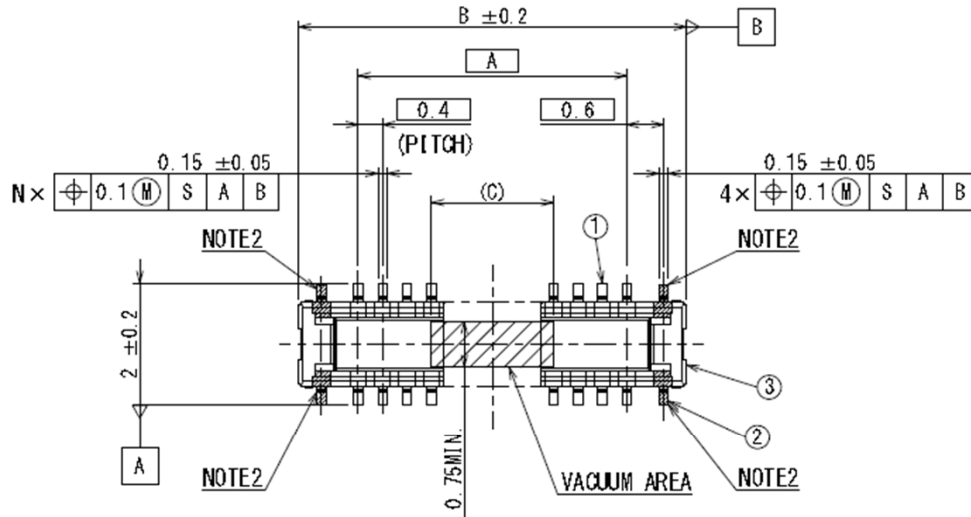

APPLICABLE P. C. B. DIMENSION (REF.)  
適合基板寸法(参考)

DIMENSIONS 寸法	DIMENSIONS		
	A	B	C
NUMBER OF CONTACT 芯数			
24	4.4	6.35	2.0
30	5.6	7.55	2.0

Note 1) Dimension  $3.9 \pm 0.05$  is recommended in case repair is needed.

Note 2) This product is grand contact.

Part Number	WP6C-S***VA1
SJ Drawing	SJ112899

# WP6C Receptacle

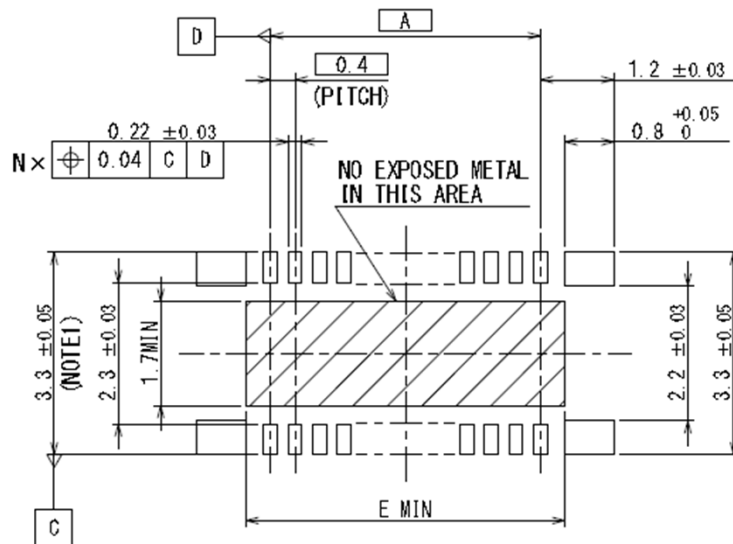
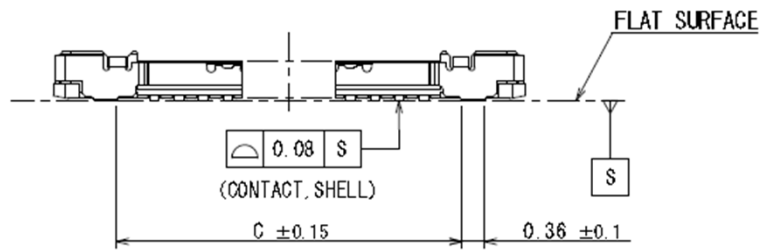
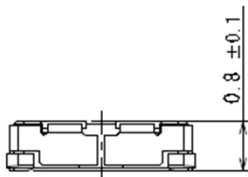
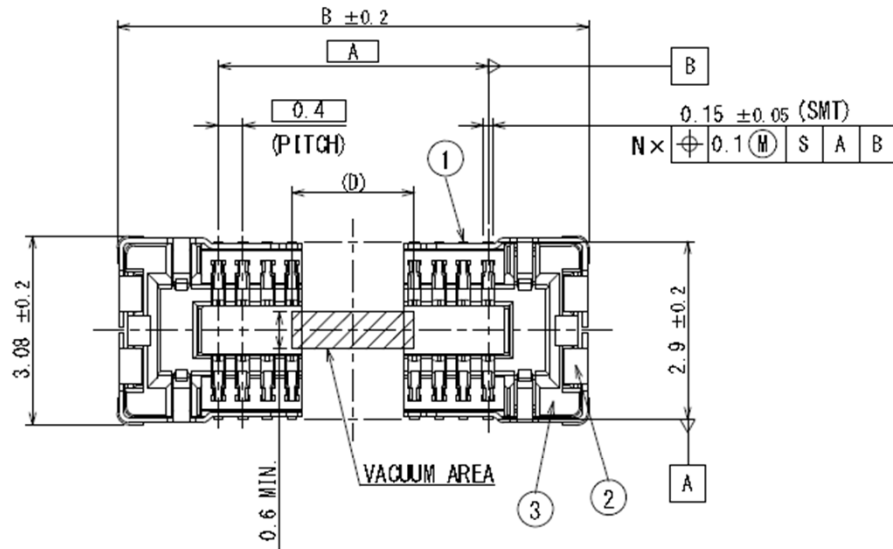

APPLICABLE P. C. B. DIMENSION (REF.)  
適合基板寸法 (参考)

NUMBER OF CONTACT 芯数	DIMENSIONS 寸法				
	A	B	C	D	E
24	4.4	7.7	5.64	2.0	5.2
30	5.6	8.9	6.84	2.0	6.4

Note 1) Dimension 3.9 ± 0.05 is recommended in case repair is needed.

Technical Documents
---------------------

Series	WP6C
SJ Drawing (Plug)	Individual Product: SJ112897 Embossed Reel: J112898
SJ Drawing (Receptacle)	Individual Product: SJ112899 Embossed Reel: SJ112900
Specification	JACS-10987
Handling Instruction	JAHL-10987
Summary Report	SR-C-1266

**Notice:**

1. The values specified in this brochure are only for reference. The products and their specifications are subject to change without notice. Contact our sales staff for further information before considering or ordering any of our products. For purchase, a product specification must be agreed upon.

2. Users are requested to provide protection circuits and redundancy circuits to ensure safety of the equipment, and sufficiently review the suitability of JAE's products to the equipment.

3. The products presented in this brochure are designed for the uses recommended below.

We strongly suggest you contact our sales staff when considering use of any of the products in any other way than the recommended applications or for a specific use that requires an extremely high reliability.

(1) Applications that require consultation:

(i) Please contact us if you are considering use involving a quality assurance program that you specify or that is peculiar to the industry, such as:

Automotive electrical components, train control, telecommunications devices (mainline), traffic light control, electric power, combustion control, fire prevention or security systems, disaster prevention equipment, etc.

(ii) We may separately give you our support with a quality assurance program that you specify, when you think of a use such as :

Aviation or space equipment, submarine repeaters, nuclear power control systems, medical equipment for life support, etc.

(2) Recommended applications include:

Computers, office appliances, telecommunications devices (terminals, mobile units), measuring equipment, audiovisual equipment, home electric appliances, factory automation equipment, etc

**Japan Aviation Electronics Industry, Limited**

\* The specifications in this brochure are subject to change without notice. Please contact JAE for information.