

SERIES: VCD40 | **DESCRIPTION:** DC-DC CONVERTER**FEATURES**

- up to 40 W isolated output
- wide input (2:1)
- 2"x2" six sided shielded metal case
- single, dual, and triple regulated outputs
- 1500 V isolation
- short circuit, over voltage and over temperature protection
- wide temperature (-25~71°C)
- efficiency up to 92%
- EN 62368-1

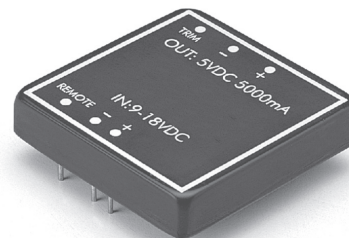

MODEL	input voltage		output voltage	input current		output current		ripple and noise ¹	efficiency
	typ (Vdc)	range (Vdc)	(Vdc)	no load (mA)	full load (mA)	max (mA)	min (mA)	max (mVp-p)	typ (%)
VCD40-D12-S2R5	12	9~18	2.5	200	2,367	10,000	0	50	88
VCD40-D12-S3R3	12	9~18	3.3	200	3,090	10,000	0	50	89
VCD40-D12-S5	12	9~18	5	200	3,745	8,000	0	50	89
VCD40-D12-S12	12	9~18	12	200	3,703	3,333	0	75	90
VCD40-D12-S15	12	9~18	15	200	3,702	2,666	0	75	90
VCD40-D12-D12	12	9~18	±12	100	4,045	±1,800	90	120	89
VCD40-D12-D15	12	9~18	±15	100	3,889	±1,400	70	150	90
VCD40-D12-T312	12	9~18	3.3/±12	200	2,784	6000/±400	600/±40	100	88
VCD40-D12-T315	12	9~18	3.3/±15	200	2,727	6000/±300	600/±30	100	88
VCD40-D12-T512	12	9~18	5/±12	200	3,750	6000/±400	600/±40	100	88
VCD40-D12-T515	12	9~18	5/±15	200	3,611	6000/±300	600/±30	100	90
VCD40-D24-S2R5	24	18~36	2.5	100	1,184	10,000	0	50	88
VCD40-D24-S3R3	24	18~36	3.3	100	1,545	10,000	0	50	89
VCD40-D24-S5	24	18~36	5	100	1,831	8,000	0	50	91
VCD40-D24-S12	24	18~36	12	100	1,811	3,333	0	75	92
VCD40-D24-S15	24	18~36	15	100	1,810	2,666	0	75	92
VCD40-D24-D12	24	18~36	±12	100	1,978	±1,800	90	120	91
VCD40-D24-D15	24	18~36	±15	100	1,902	±1,400	70	150	92
VCD40-D24-T312	24	18~36	3.3/±12	100	1,361	6000/±400	600/±40	100	90
VCD40-D24-T315	24	18~36	3.3/±15	100	1,333	6000/±300	600/±30	100	90
VCD40-D24-T512	24	18~36	5/±12	100	1,833	6000/±400	600/±40	100	90
VCD40-D24-T515	24	18~36	5/±15	100	1,806	6000/±300	600/±30	100	90
VCD40-D48-S2R5	48	36~72	2.5	50	585	10,000	0	50	89
VCD40-D48-S3R3	48	36~72	3.3	50	764	10,000	0	50	90
VCD40-D48-S5	48	36~72	5	60	926	8,000	0	50	90
VCD40-D48-S12	48	36~72	12	60	916	3,333	0	75	91
VCD40-D48-S15	48	36~72	15	60	906	2,666	0	75	92
VCD40-D48-D12	48	36~72	±12	50	1,000	±1,800	90	120	90
VCD40-D48-D15	48	36~72	±15	50	962	±1,400	70	150	91

MODEL	input voltage		output voltage	input current		output current		ripple and noise ¹	efficiency
	typ (Vdc)	range (Vdc)	(Vdc)	no load (mA)	full load (mA)	max (mA)	min (mA)	max (mVp-p)	typ (%)
VCD40-D48-T312	48	36~72	3.3/±12	50	688	6000/±400	600/±40	100	89
VCD40-D48-T315	48	36~72	3.3/±15	50	690	6000/±300	600/±30	100	89
VCD40-D48-T512	48	36~72	5/±12	50	938	6000/±400	600/±40	100	88
VCD40-D48-T515	48	36~72	5/±15	50	903	6000/±300	600/±30	100	90

notes: 1. ripple and noise are measured at 20 Hz BW

PART NUMBER KEY

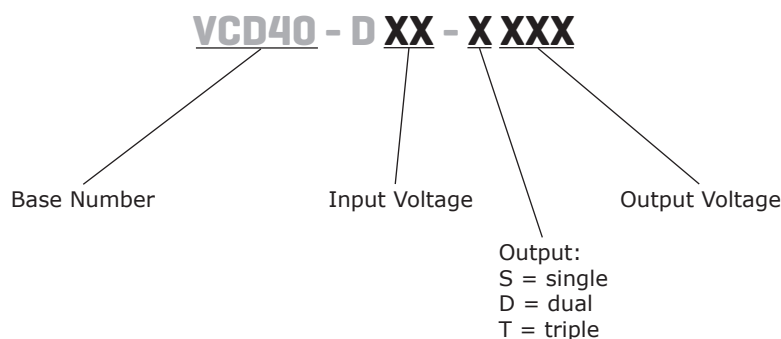

INPUT

parameter	conditions/description	min	typ	max	units
operating input voltage		9	12	18	Vdc
		18	24	36	Vdc
		36	48	72	Vdc
under voltage lockout	12 Vin power up			8.8	Vdc
	12 Vin power down			8.0	Vdc
	24 Vin power up			17	Vdc
	24 Vin power down			16	Vdc
	48 Vin power up			34	Vdc
	48 Vin power down			32	Vdc
input filter	PI type				

OUTPUT

parameter	conditions/description	min	typ	max	units
line regulation ¹	single and dual output models			±0.5	%
	triple output models	main		±1.0	%
		auxillary		±3.0	%
load regulation ²	single and dual output models			±0.5	%
	dual positive output models	3.3V		±1.5	%
		5V		±4.0	%
	triple output models	main		±1.0	%
		auxillary		±4.0	%
voltage accuracy	single output models			±1.5	%
	dual positive output models	3.3V		±1.5	%
		5V		±3.0	%
	triple output models	main		±1.5	%
		auxillary		±5.0	%

OUTPUT

parameter	conditions/description	min	typ	max	units
cross regulation ³	+3.3V			±1.0	%
	+5V			±4.0	%
voltage balance	dual output models			±2.0	%
transient response	75-100% step load change ±5% error band			300	µs
external trim adjust range	single and dual output models		±10		%
	dual positive output models		±5		%
current limit		110		140	%
switching frequency			350		kHz
temperature coefficient				±0.02	%/°C

Notes: 1. measured from high line to low line
2. measured from full load to 10% load
2. measured from max. load to 10% load, other output at 10% load

PROTECTIONS

parameter	conditions/description	min	typ	max	units
short circuit protection	continuous, hiccup				
over temperature protection			110		°C
over-voltage protection	zener diode clamp	2.5V		3.6	Vdc
		3.3V		3.9	Vdc
		5V		6.2	Vdc
		12V		15	Vdc
		15V		18	Vdc

SAFETY AND COMPLIANCE

parameter	conditions/description	min	typ	max	units
isolation voltage		1,500			Vdc
insulation resistance		1,000			MΩ
safety approvals	certified to 62368-1: EN certified to 60950-1: UL				
RoHS compliant	yes				

ENVIRONMENTAL

parameter	conditions/description	min	typ	max	units
operating temperature ¹		-40		85	°C
case temperature ¹				100	°C
storage temperature		-55		105	°C

Notes: 1. measured from high line to low line

DERATING CURVES

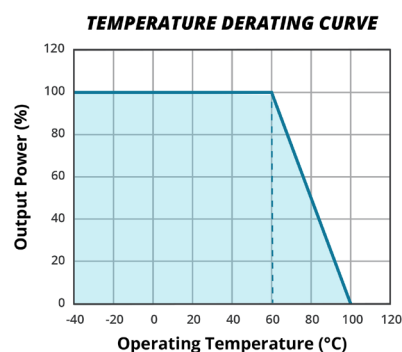

MECHANICAL

parameter	conditions/description	min	typ	max	units
dimensions	2 x 2 x 0.4 (50.8 x 50.8 x 10.2 mm)				inch
case material	black coated copper with non-conductive base				
weight			65		g

MECHANICAL DRAWING

units: inches (mm)

tolerance: x.xx = ±0.02, x.xxx = ±0.010

(x.x = ±0.5, x.xx = ±0.25)

pin tolerance ±0.05mm

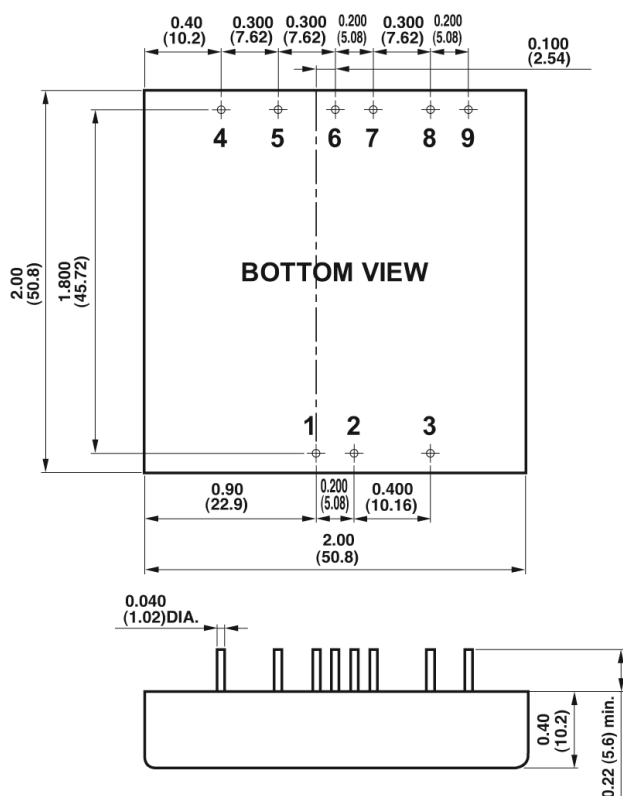

PIN CONNECTIONS				
	SINGLE OUTPUT	DUAL OUTPUT	DUAL POSITIVE	TRIPLE OUTPUT
PIN	FUNCTION	FUNCTION	FUNCTION	FUNCTION
1	+Vin	+Vin	+Vin	+Vin
2	-Vin	-Vin	-Vin	-Vin
3	on/off	on/off	on/off	on/off
4	NC	no pin	+3.3Vo	+Aux. out
5	-sense	+Vo	com(5V RTN)	common
6	+sense	common	trim	-Aux. out
7	+Vo	common	NC	+Vo
8	-Vo	-Vo	+5 Vo	-Vo (common)
9	trim	trim	com(5V RTN)	NC

REMOTE ON/OFF CONTROL	
logic compatibility	CMOS or Open Collector TTL
EC-on	>+5.5 Vdc or Open Circuit
EC-off	<1.8 Vdc
shutdown idle current	10 mA
control common	referenced to input minus

TRIPLE OUTPUT LOADING TABLE ¹			
PIN	VOLTAGE	AMPERES	
		min ²	typ
7	+5	0.50	3.5
8,5	±12	0.10	0.31
8,5	±15	0.10	0.25

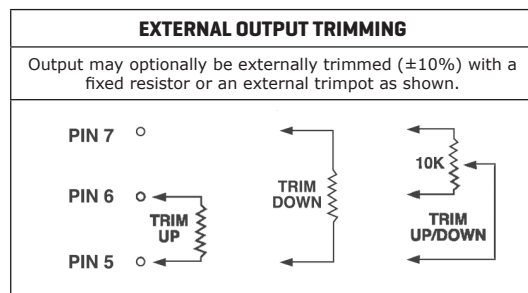

- Notes:
- Maximum total power from all outputs is limited to 25 watts but no output should exceed its maximum current.
 - Minimum current on each output is required to maintain specified regulation.

1. The value of Rtrim-up defined as:

$$R_{trim-up} = \left(\frac{R1 \times Vr}{Vo - Vo,nom} \right) - Rt \text{ (K}\Omega\text{)}$$

Where: R trim-up is the external resistor in Kohm.
Vo,nom is the nominal output voltage.
Vo is the desired output voltage.

R1 ,Rt and Vr are internal to the unit and are defined in Table 1.

For example, to trim-up the output voltage of 5.0V module (VCD40-D48-S5) by 5% to 5.25V, R trim-up is calculated as follows:

$$Vo - Vo,nom = 5.25 - 5.0 = 0.25V$$

$$R1 = 2.32 \text{ Kohm}$$

$$Rt = 8.2 \text{ Kohm}, Vr = 2.5$$

$$R_{trim-up} = \frac{2.32 \times 2.5}{0.25} - 8.2 = 15 \text{ (K}\Omega\text{)}$$

The value of R trim-down defined as:

$$R_{trim-down} = \frac{R1 \times (Vo - Vr)}{Vo,nom - Vo} - Rt \text{ (K}\Omega\text{)}$$

Where: R trim-down is the external resistor in Kohm.
Vo,nom is the nominal output voltage.
Vo is the desired output voltage.

R1 ,Rt and Vr are internal to the unit and are defined in Table 1.

For example, to trim-down the output voltage of 5.0V module (VCD40-D48-S5) by 5% to 4.75V, R trim-down is calculated as follows :

$$Vo,nom - Vo = 5.0 - 4.75 = 0.25 \text{ V}$$

$$R1 = 2.32 \text{ Kohm}$$

$$Rt = 8.2 \text{ Kohm}, Vr = 2.5$$

$$R_{trim-down} = \frac{2.32 \times (4.75 - 2.5)}{0.25} - 8.2 = 12.68 \text{ (K}\Omega\text{)}$$

Table 1 - Trim Resistor Values

Model Number	Output Voltage(V)	R1 (Kohm)	Rt (Kohm)	Vr
VCD40-D24-S5 VCD40-D48-S5	5.0	2.32	8.2	2.5

Table 2 - Trim Resistor Values

Model Number	Output Voltage(V)	R1 (Kohm)	R2 (Kohm)	R3 (Kohm)	Rt (Kohm)	Vr
VCD40-D24-S3R3 VCD40-D48-S3R3	3.3V	2.74	1.8	0.27	9.1	1.24
VCD40-D24-S12 VCD40-D48-S12	12V	6.8	2.4	2.32	22	2.5
VCD40-D24-S15 VCD40-D48-S15	15V	8.06	2.4	3.9	27	2.5

In order to trim the voltage up or down one needs to connect the trim resistor either between the trim pin and -Vo for trim-up and between trim pin and +Vo for trim-down. The output voltage trim range is ±10%. This is shown in Figures 1 and 2:

2. The output Voltage 3.3V,12V and 15V value of Rtrim are defined as below:

$$R_{trim-up} = \left(\frac{Vr \times R1 \times (R2 + R3)}{(Vo - Vo,nom) \times R2} \right) - Rt \text{ (K}\Omega\text{)}$$

$$R_{trim-down} = R1 \times \left(\frac{Vr \times R1}{(Vo,nom - Vo) \times R2} - 1 \right) - Rt \text{ (K}\Omega\text{)}$$

Where: R trim-up is the external resistor in Kohm.

Vo,nom is the nominal output voltage.

Vo is the desired output voltage.

R1, R2, R3, Rt and Vr are internal to the unit and are defined in Table 2.

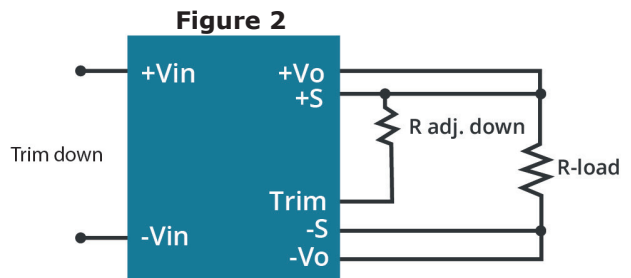
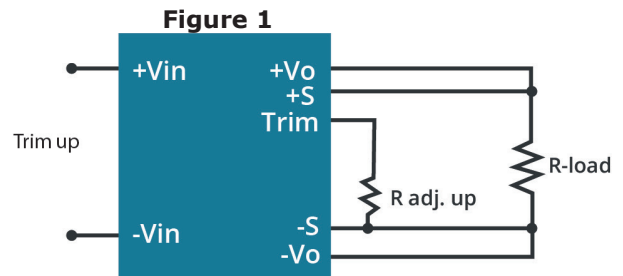

Note: All specifications measured at 25°C, nominal input voltage, and full load unless otherwise noted.

REVISION HISTORY

rev.	description	date
1.0	initial release	06/28/2007
1.01	layout update, addition of triple output loading table	10/09/2009
1.02	new template applied, V-Infinity branding removed	09/07/2012
1.03	spec updated	04/01/2013
1.04	safeties updated in features and safety line	03/23/2021
1.05	derating curve and trim figures updated	08/31/2021

The revision history provided is for informational purposes only and is believed to be accurate.



Headquarters
20050 SW 112th Ave.
Tualatin, OR 97062
800.275.4899

Fax 503.612.2383
cui.com
techsupport@cui.com

CUI offers a two (2) year limited warranty. Complete warranty information is listed on our website.

CUI reserves the right to make changes to the product at any time without notice. Information provided by CUI is believed to be accurate and reliable. However, no responsibility is assumed by CUI for its use, nor for any infringements of patents or other rights of third parties which may result from its use.

CUI products are not authorized or warranted for use as critical components in equipment that requires an extremely high level of reliability. A critical component is any component of a life support device or system whose failure to perform can be reasonably expected to cause the failure of the life support device or system, or to affect its safety or effectiveness.