

Description: MULTI BAND SWIVEL MOUNT DIPOLE
698-960&1400-1700&1710-2690MHz

Series: Blade Antenna

PART NUMBER: **W5095X**



W5095

W5095K

Features:

- 698-2690MHz
- Gain 1-2.5dBi
- IP65
- Total length 229mm (straight)
- Total length 197.5mm (bent)
- Width 30.5mm
- Connector options:
 - W5095 TNC male
 - W5095K SMA male

Applications:

- LTE radios
- 2G/3G/4G radios
- Gateways, set top boxes, security
- Optimized for straight and 90deg bent positions

Issue: 1849

In the effort to improve our products, we reserve the right to make changes judged to be necessary.

CONFIDENTIAL AND PROPRIETARY INFORMATION

This document contains confidential and proprietary information of Pulse Electronics, Inc. (Pulse) and is protected by copyright, trade secret and other state and federal laws. Its receipt or possession does not convey any rights to reproduce, disclose its contents, or to manufacture, use or sell anything it may describe. Reproduction, disclosure or use without specific written authorization of Pulse is strictly forbidden.

For more information:

Pulse Worldwide Headquarters
12220 World Trade Drive
San Diego, CA 92128
USA
Tel: 1-858-674-8100

Pulse/Larsen Antennas
18110 SE 34th St Bldg 2 Suite 250
Vancouver, WA 98683
USA
Tel: 1-360-944-7551

Europe Headquarters
Pulse GmbH & Do, KG
Zeppelinstrasse 15
Herrenberg, Germany
Tel: 49 7032 7806 0

Pulse (Suzhou) Wireless Products Co, Inc.
99 Huo Ju Road(#29 Bldg,4th Phase
Suzhou New District
Jiangsu Province, Suzhou 215009 PR China
Tel: 86 512 6807 9998



Description: MULTI BAND SWIVEL MOUNT DIPOLE
698-960&1400-1700&1710-2690MHz

Series: Blade Antenna

PART NUMBER: W5095X

ELECTRICAL SPECIFICATIONS

Frequency	698-960/1400-1700/1710-2690	MHz
Nominal Impedance	50	Ω
VSWR	2.5:1 @698-960MHz 3:1 @1400-1700MHz 2.5:1 @1710-2690MHz	
Gain (698-960MHz)	1.0	dBi+/- 1dB
Gain (1400-2170MHz)	1.07	dBi+/- 1dB
Gain (2300-2500MHz))	1.48	dBi+/- 1dB
Gain (2500-2690MHz))	2.16	dBi+/- 1dB
Average Efficiency(698-960MHz)	60	%
Average Efficiency(1400-2170MHz)	65	%
Average Efficiency(2300-2500MHz)	70	%
Average Efficiency(2500-2690MHz)	85	%
Horizontal Plane	OMNI	
Polarization	Vertical	
Power withstanding	3	W
Connector type	TNC male (SMA male is optional)	
Connector Options	W5095	TNC male connector
	W5095K	SMA male connector

Issue: 1849

In the effort to improve our products, we reserve the right to make changes judged to be necessary.

CONFIDENTIAL AND PROPRIETARY INFORMATION

This document contains confidential and proprietary information of Pulse Electronics, Inc. (Pulse) and is protected by copyright, trade secret and other state and federal laws. Its receipt or possession does not convey any rights to reproduce, disclose its contents, or to manufacture, use or sell anything it may describe. Reproduction, disclosure or use without specific written authorization of Pulse is strictly forbidden.

Description: MULTI BAND SWIVEL MOUNT DIPOLE
698-960&1400-1700&1710-2690MHz

Series: Blade Antenna

PART NUMBER: **W5095X**

MECHANICAL SPECIFICATIONS

Plastic radome	ABS/PC
Color	Black
Flammability	UL94-V0
Ingress Protection	IP65
Weight	50 g
Wind-loading	100 mph
Overall Length	9[229] INCHES[mm]
Position	0°, 45° & 90°

ENVIRONMENTAL SPECIFICATIONS

Operating temperature	-40/+85 ° C
Storage Temperature	-40/+85 ° C
Salt mist	96 hours

Description: MULTI BAND SWIVEL MOUNT DIPOLE
698-960&1400-1700&1710-2690MHz

Series: Blade Antenna

PART NUMBER: W5095X

MECHANICAL DRAWING

W5095 TNC male connector

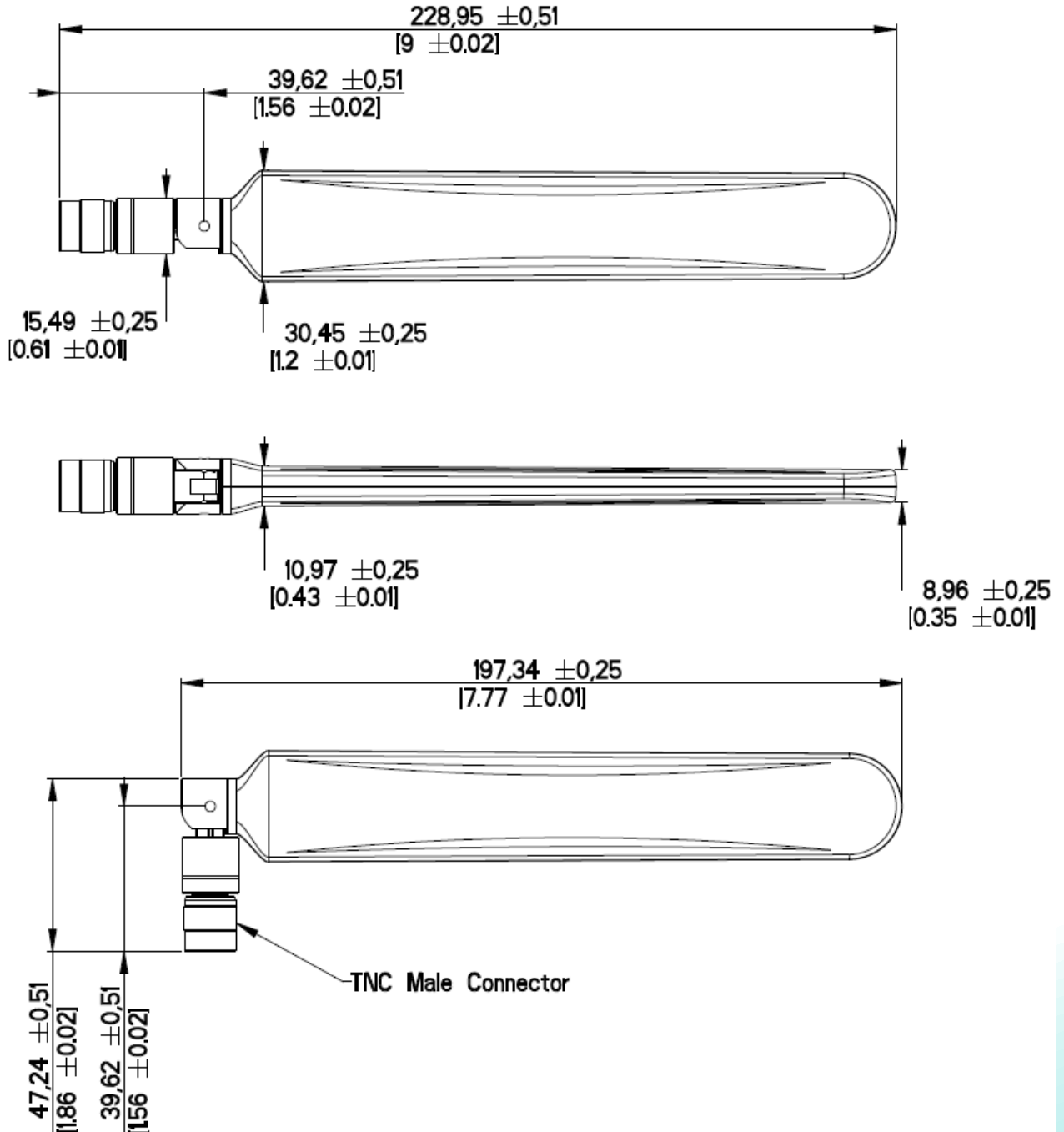

Issue: 1849

In the effort to improve our products, we reserve the right to make changes judged to be necessary.

CONFIDENTIAL AND PROPRIETARY INFORMATION

This document contains confidential and proprietary information of Pulse Electronics, Inc. (Pulse) and is protected by copyright, trade secret and other state and federal laws. Its receipt or possession does not convey any rights to reproduce, disclose its contents, or to manufacture, use or sell anything it may describe. Reproduction, disclosure or use without specific written authorization of Pulse is strictly forbidden.

Description: MULTI BAND SWIVEL MOUNT DIPOLE
698-960&1400-1700&1710-2690MHz

Series: Blade Antenna

PART NUMBER: W5095X

MECHANICAL DRAWING

W5095K SMA Male connector

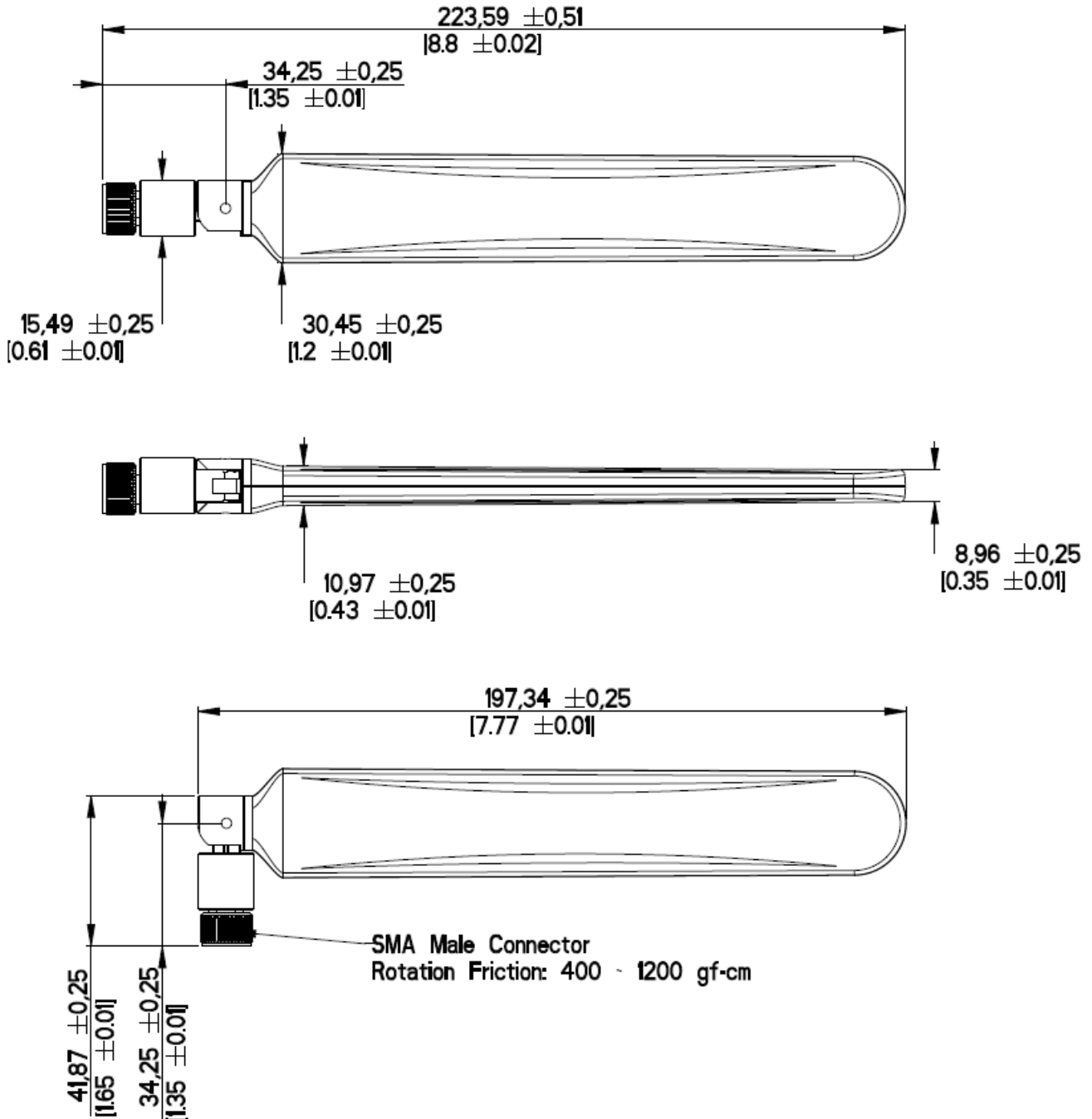

Issue: 1849

In the effort to improve our products, we reserve the right to make changes judged to be necessary.

CONFIDENTIAL AND PROPRIETARY INFORMATION

This document contains confidential and proprietary information of Pulse Electronics, Inc. (Pulse) and is protected by copyright, trade secret and other state and federal laws. Its receipt or possession does not convey any rights to reproduce, disclose its contents, or to manufacture, use or sell anything it may describe. Reproduction, disclosure or use without specific written authorization of Pulse is strictly forbidden.

Description: MULTI BAND SWIVEL MOUNT DIPOLE
698-960&1400-1700&1710-2690MHz

Series: Blade Antenna

PART NUMBER: W5095X

OTHER SPECIFICATIONS

VSWR

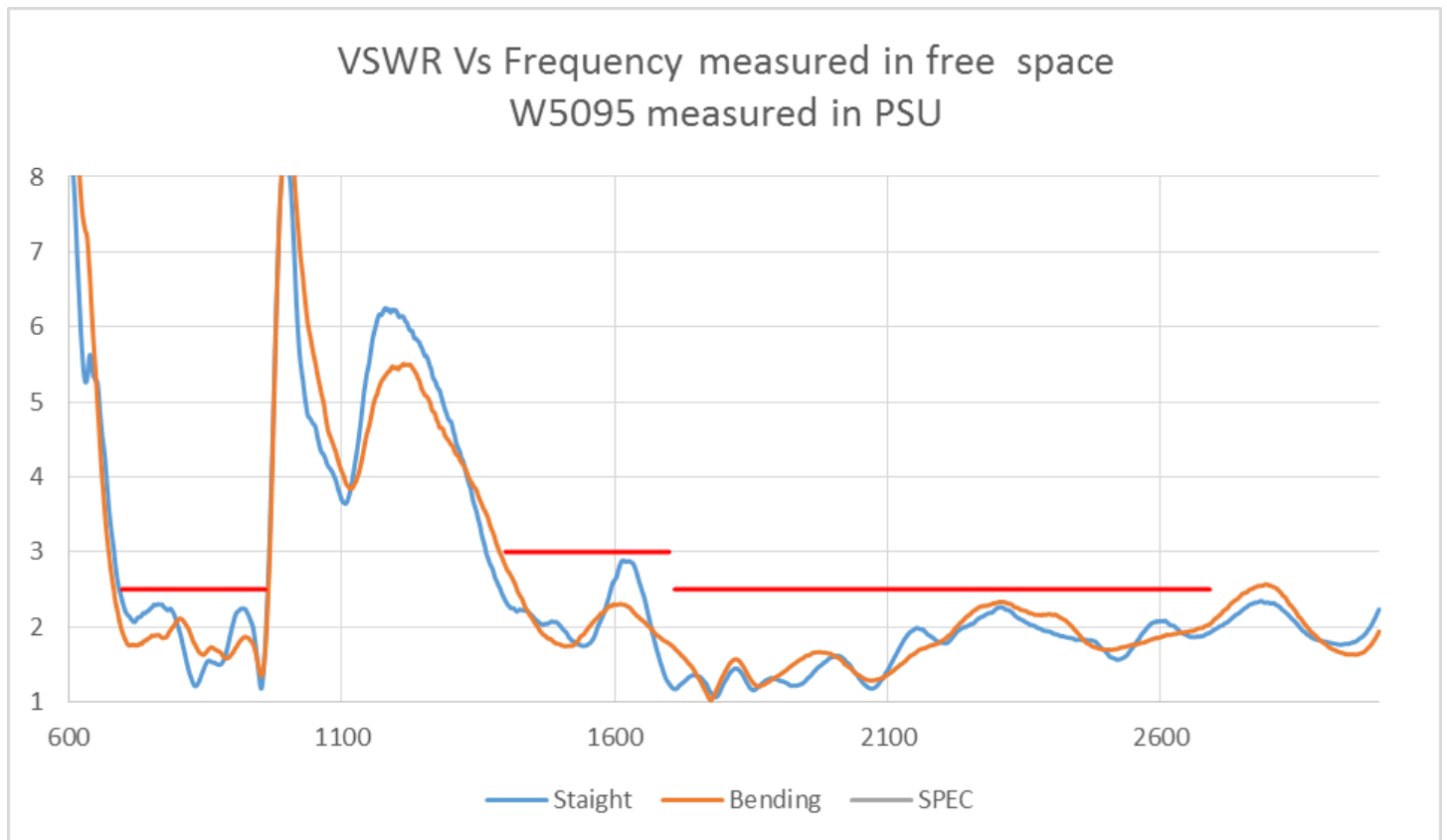

Issue: 1849

In the effort to improve our products, we reserve the right to make changes judged to be necessary.

CONFIDENTIAL AND PROPRIETARY INFORMATION

This document contains confidential and proprietary information of Pulse Electronics, Inc. (Pulse) and is protected by copyright, trade secret and other state and federal laws. Its receipt or possession does not convey any rights to reproduce, disclose its contents, or to manufacture, use or sell anything it may describe. Reproduction, disclosure or use without specific written authorization of Pulse is strictly forbidden.

Description: MULTI BAND SWIVEL MOUNT DIPOLE
698-960&1400-1700&1710-2690MHz

Series: Blade Antenna

PART NUMBER: W5095X

CHARTS

Efficiency

Efficiency vs Frequency measured in free space
W5095 measured in PSU

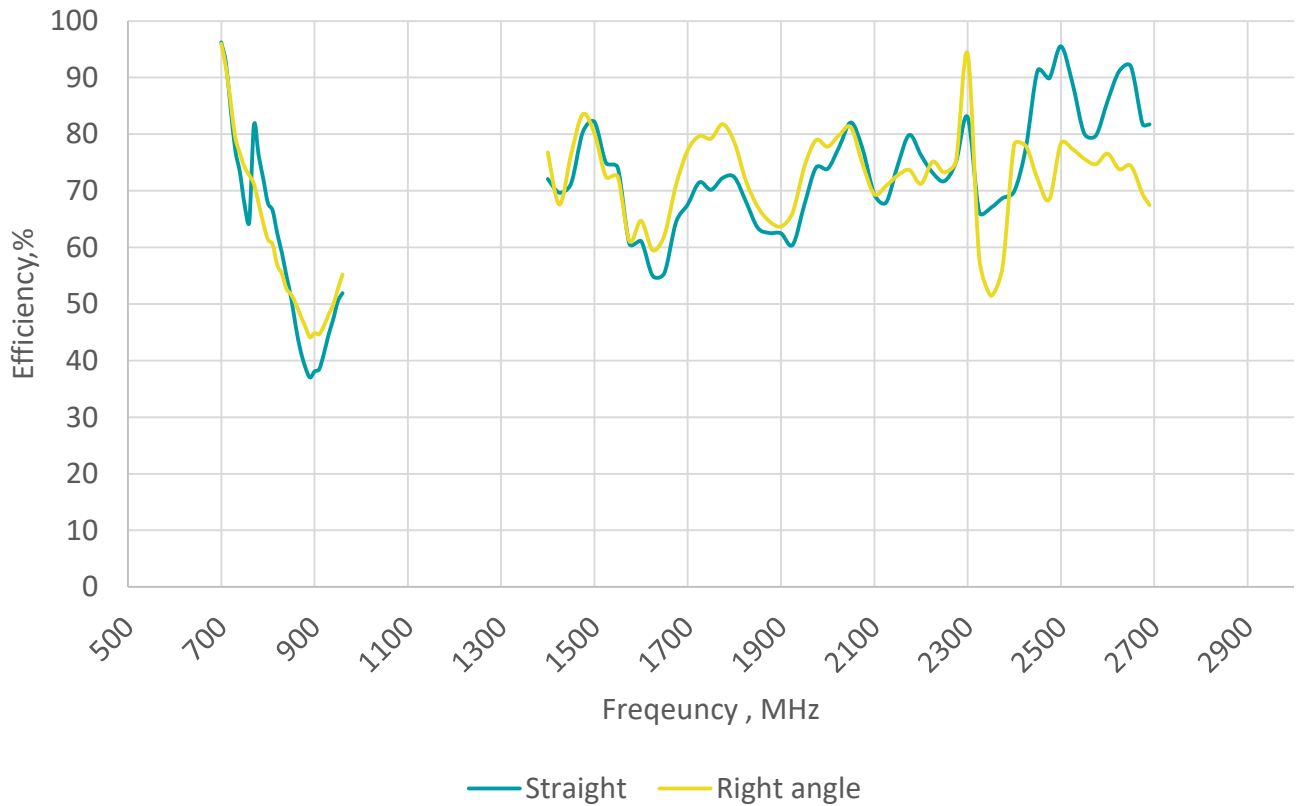

Issue: 1849

In the effort to improve our products, we reserve the right to make changes judged to be necessary.

CONFIDENTIAL AND PROPRIETARY INFORMATION

This document contains confidential and proprietary information of Pulse Electronics, Inc. (Pulse) and is protected by copyright, trade secret and other state and federal laws. Its receipt or possession does not convey any rights to reproduce, disclose its contents, or to manufacture, use or sell anything it may describe. Reproduction, disclosure or use without specific written authorization of Pulse is strictly forbidden.

Description: MULTI BAND SWIVEL MOUNT DIPOLE
698-960&1400-1700&1710-2690MHz

Series: Blade Antenna

PART NUMBER: W5095X

CHARTS

Peak Gain

Peak Gain vs Frequency measured in free space
W5095 measured in PSU

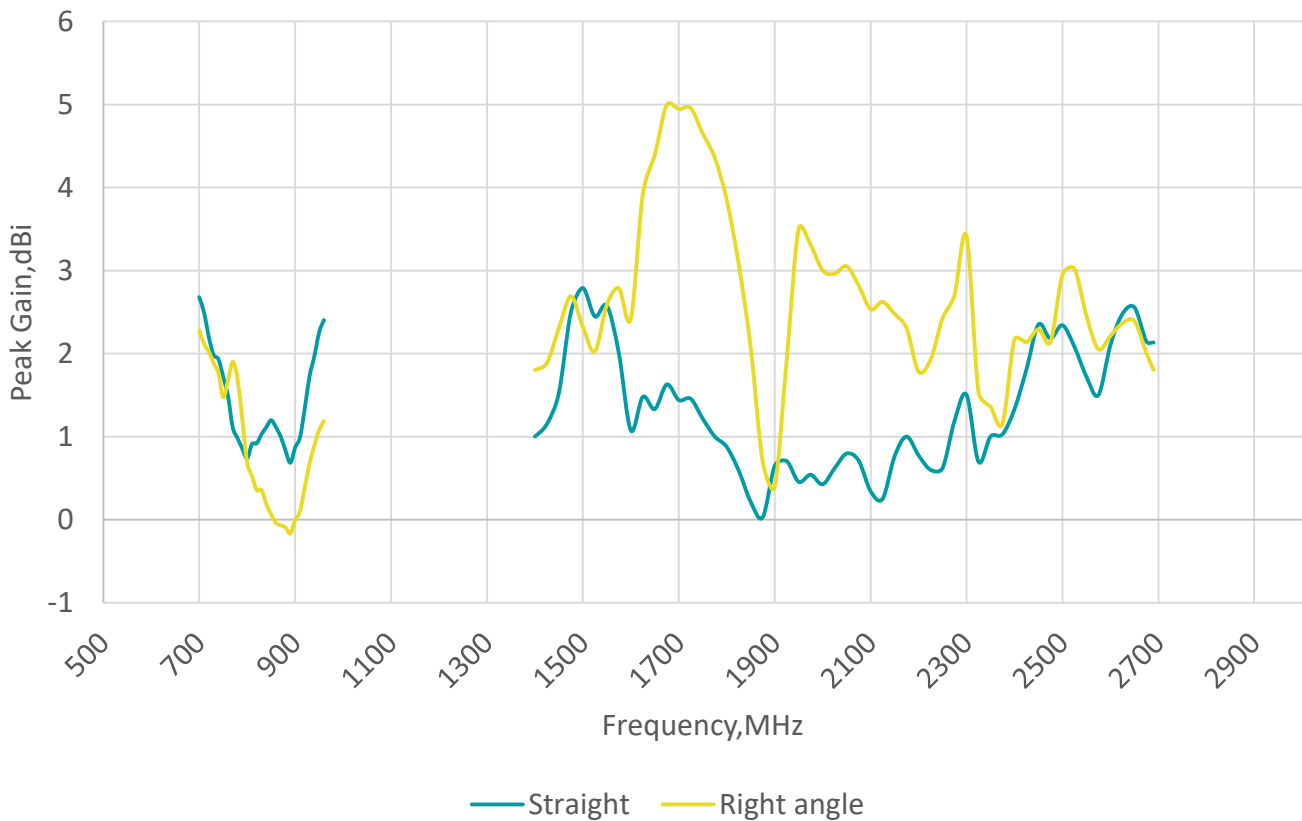

Issue: 1849

In the effort to improve our products, we reserve the right to make changes judged to be necessary.

CONFIDENTIAL AND PROPRIETARY INFORMATION

This document contains confidential and proprietary information of Pulse Electronics, Inc. (Pulse) and is protected by copyright, trade secret and other state and federal laws. Its receipt or possession does not convey any rights to reproduce, disclose its contents, or to manufacture, use or sell anything it may describe. Reproduction, disclosure or use without specific written authorization of Pulse is strictly forbidden.

Description: MULTI BAND SWIVEL MOUNT DIPOLE
698-960&1400-1700&1710-2690MHz

Series: Blade Antenna

PART NUMBER: W5095X

CHARTS

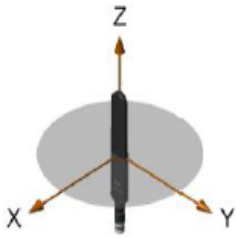

Gain Plots

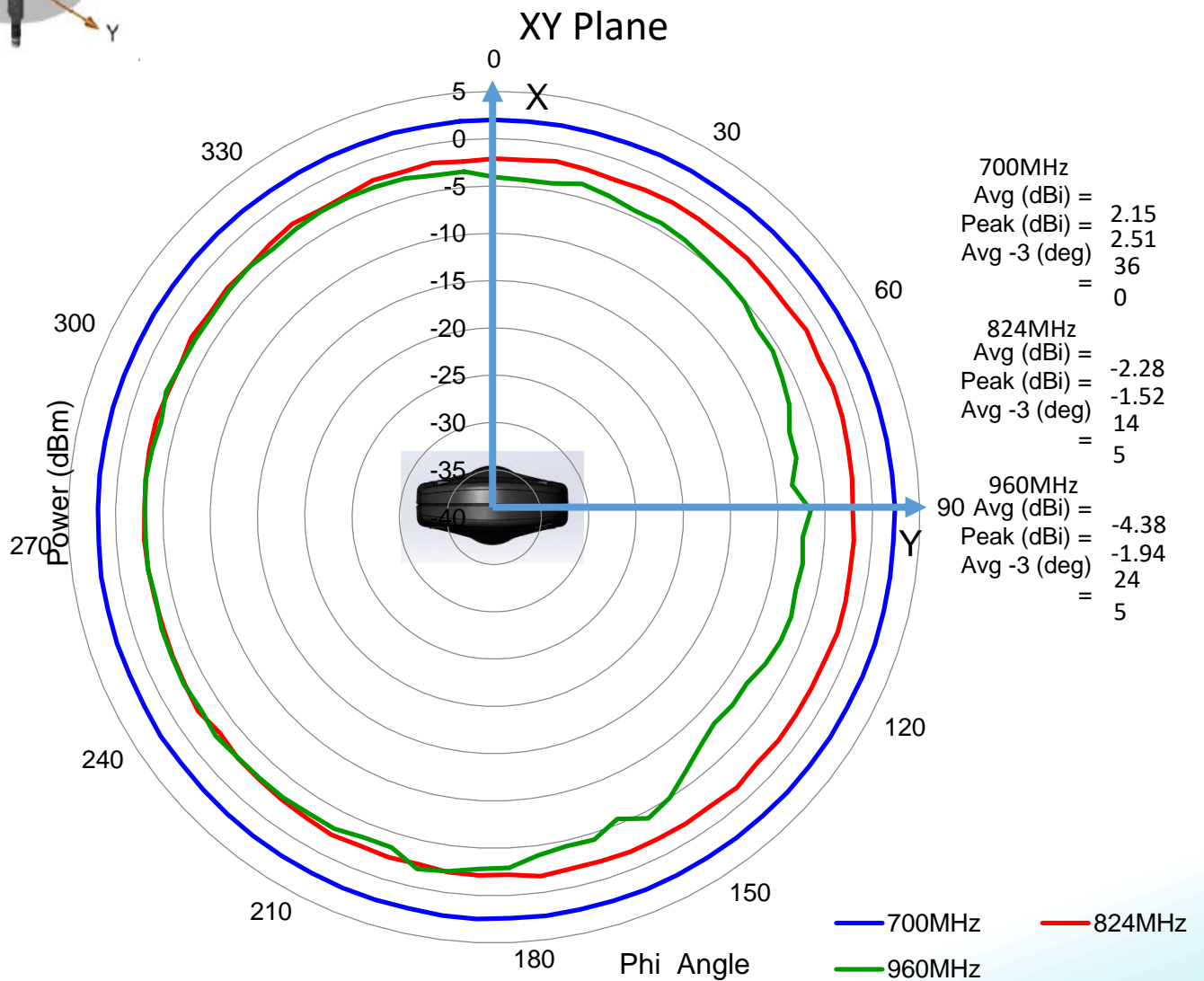

Issue: 1849

In the effort to improve our products, we reserve the right to make changes judged to be necessary.

CONFIDENTIAL AND PROPRIETARY INFORMATION

This document contains confidential and proprietary information of Pulse Electronics, Inc. (Pulse) and is protected by copyright, trade secret and other state and federal laws. Its receipt or possession does not convey any rights to reproduce, disclose its contents, or to manufacture, use or sell anything it may describe. Reproduction, disclosure or use without specific written authorization of Pulse is strictly forbidden.



Description: MULTI BAND SWIVEL MOUNT DIPOLE
698-960&1400-1700&1710-2690MHz

Series: Blade Antenna

PART NUMBER: W5095X

CHARTS

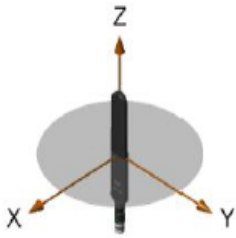

Gain Plots

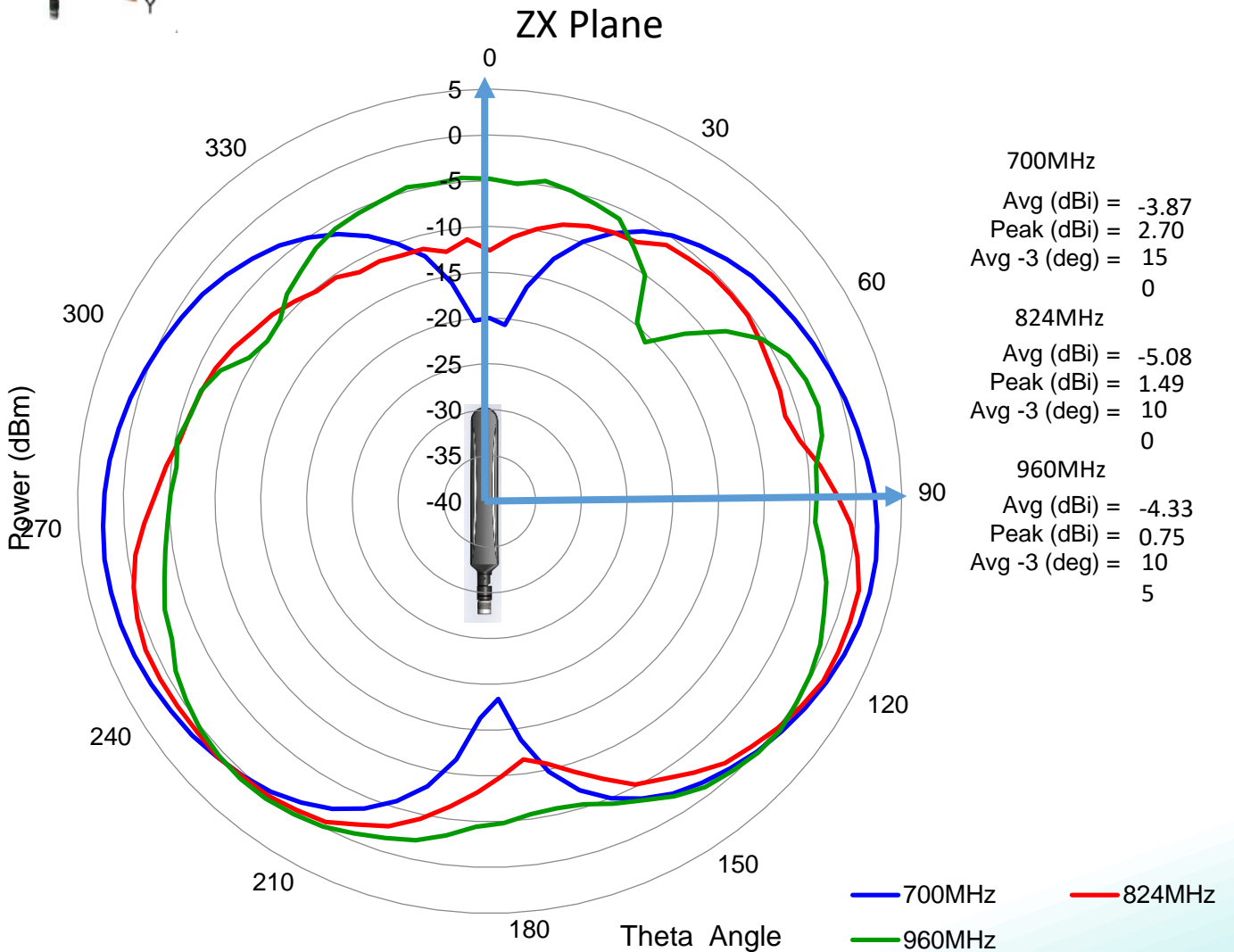

Issue: 1849

In the effort to improve our products, we reserve the right to make changes judged to be necessary.

CONFIDENTIAL AND PROPRIETARY INFORMATION

This document contains confidential and proprietary information of Pulse Electronics, Inc. (Pulse) and is protected by copyright, trade secret and other state and federal laws. Its receipt or possession does not convey any rights to reproduce, disclose its contents, or to manufacture, use or sell anything it may describe. Reproduction, disclosure or use without specific written authorization of Pulse is strictly forbidden.



Description: MULTI BAND SWIVEL MOUNT DIPOLE
698-960&1400-1700&1710-2690MHz

Series: Blade Antenna

PART NUMBER: W5095X

CHARTS

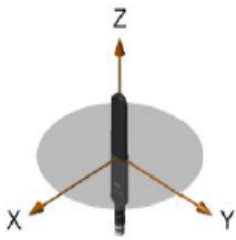

Gain Plots

YZ Plane

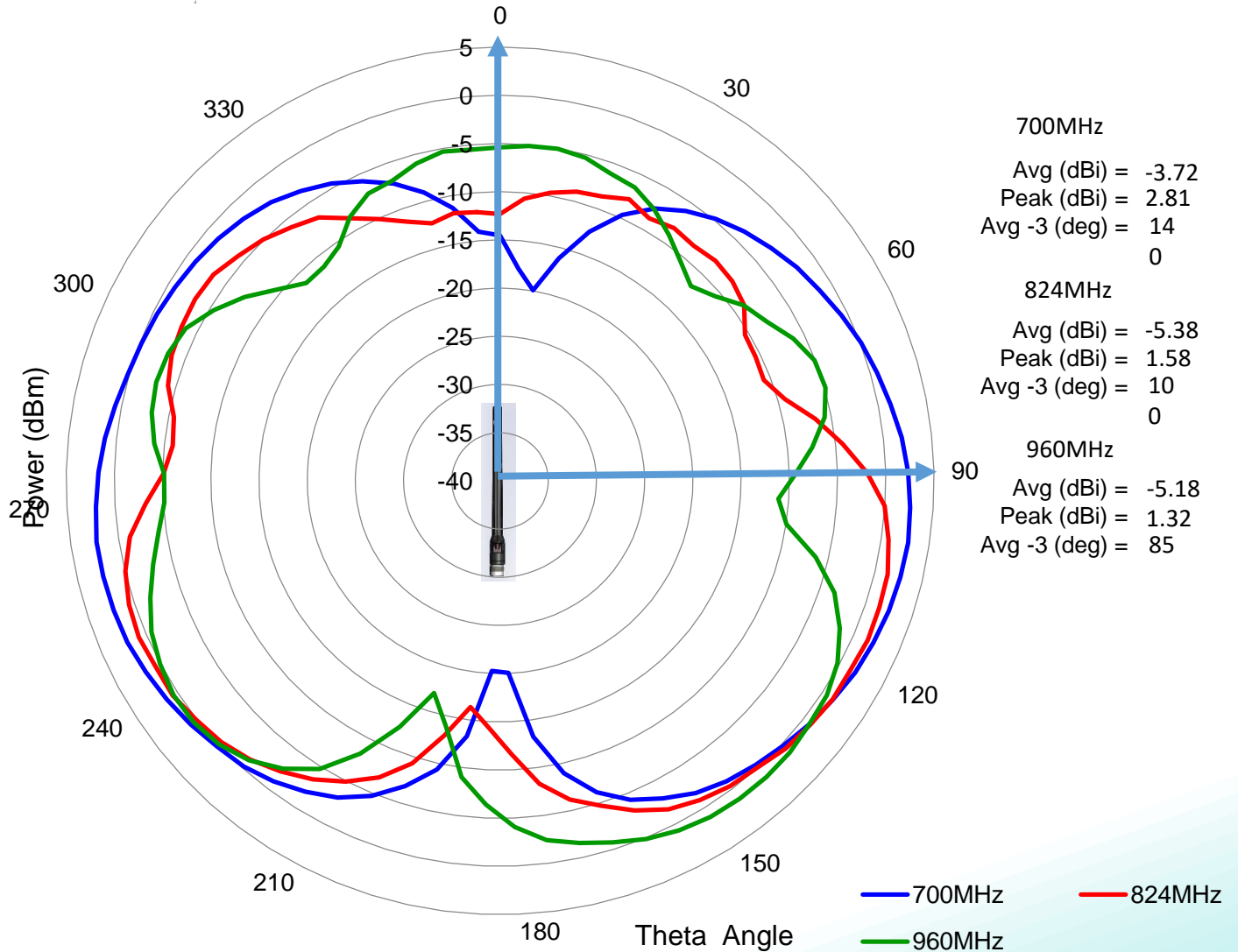

Issue: 1849

In the effort to improve our products, we reserve the right to make changes judged to be necessary.

CONFIDENTIAL AND PROPRIETARY INFORMATION

This document contains confidential and proprietary information of Pulse Electronics, Inc. (Pulse) and is protected by copyright, trade secret and other state and federal laws. Its receipt or possession does not convey any rights to reproduce, disclose its contents, or to manufacture, use or sell anything it may describe. Reproduction, disclosure or use without specific written authorization of Pulse is strictly forbidden.



Description: MULTI BAND SWIVEL MOUNT DIPOLE
698-960&1400-1700&1710-2690MHz

Series: Blade Antenna

PART NUMBER: W5095X

CHARTS

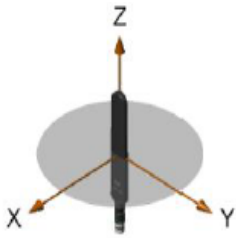

Gain Plots

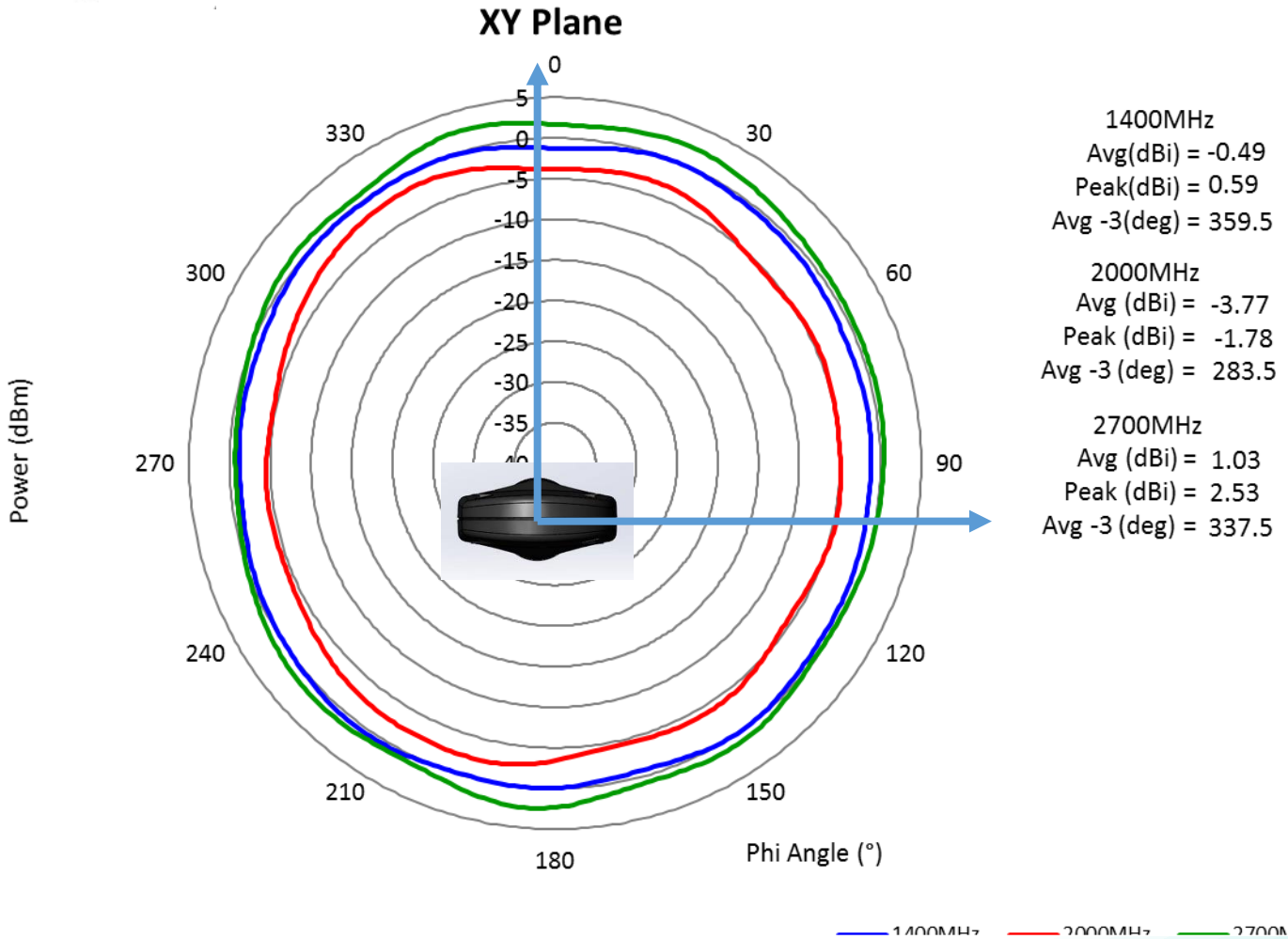

Issue: 1849

In the effort to improve our products, we reserve the right to make changes judged to be necessary.
CONFIDENTIAL AND PROPRIETARY INFORMATION

This document contains confidential and proprietary information of Pulse Electronics, Inc. (Pulse) and is protected by copyright, trade secret and other state and federal laws. Its receipt or possession does not convey any rights to reproduce, disclose its contents, or to manufacture, use or sell anything it may describe. Reproduction, disclosure or use without specific written authorization of Pulse is strictly forbidden.

Description: MULTI BAND SWIVEL MOUNT DIPOLE
698-960&1400-1700&1710-2690MHz

Series: Blade Antenna

PART NUMBER: W5095X

CHARTS

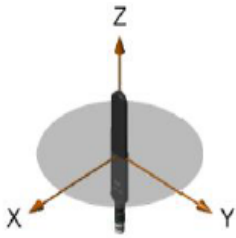

Gain Plots

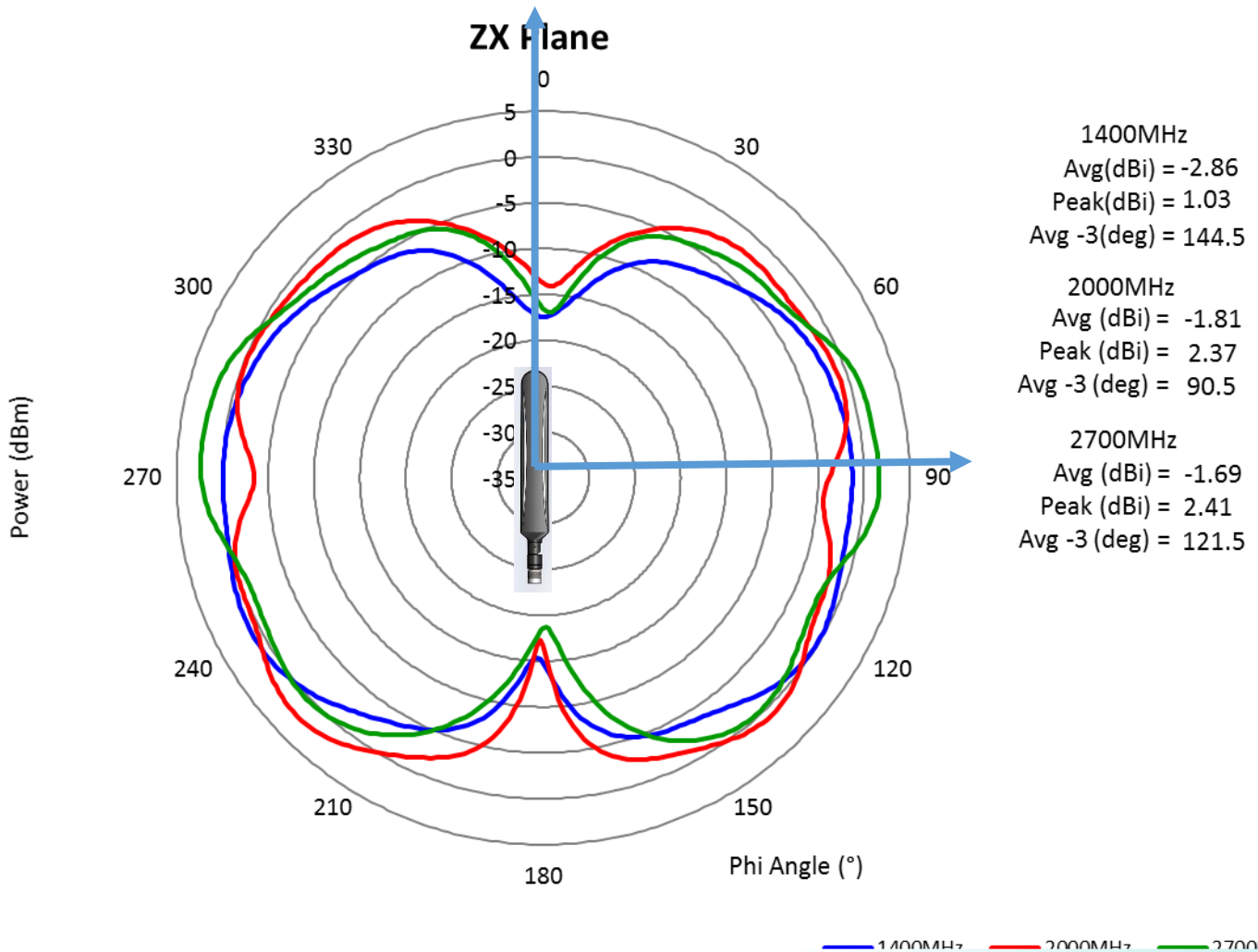

Issue: 1849

In the effort to improve our products, we reserve the right to make changes judged to be necessary.
CONFIDENTIAL AND PROPRIETARY INFORMATION

This document contains confidential and proprietary information of Pulse Electronics, Inc. (Pulse) and is protected by copyright, trade secret and other state and federal laws. Its receipt or possession does not convey any rights to reproduce, disclose its contents, or to manufacture, use or sell anything it may describe. Reproduction, disclosure or use without specific written authorization of Pulse is strictly forbidden.

Description: MULTI BAND SWIVEL MOUNT DIPOLE
698-960&1400-1700&1710-2690MHz

Series: Blade Antenna

PART NUMBER: W5095X

CHARTS

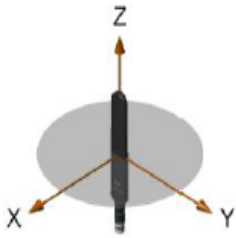

Gain Plots

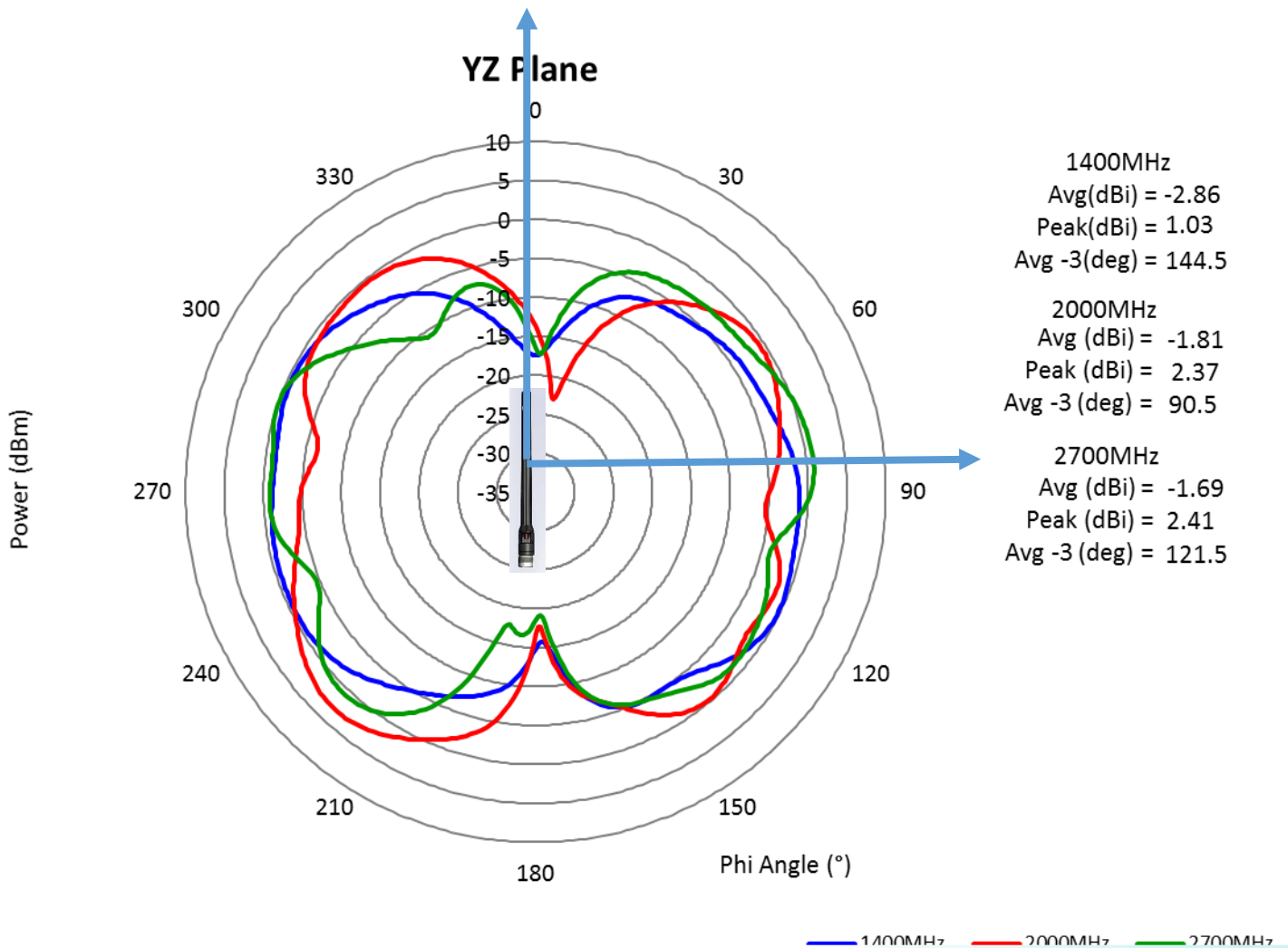

Issue: 1849

In the effort to improve our products, we reserve the right to make changes judged to be necessary.
CONFIDENTIAL AND PROPRIETARY INFORMATION

This document contains confidential and proprietary information of Pulse Electronics, Inc. (Pulse) and is protected by copyright, trade secret and other state and federal laws. Its receipt or possession does not convey any rights to reproduce, disclose its contents, or to manufacture, use or sell anything it may describe. Reproduction, disclosure or use without specific written authorization of Pulse is strictly forbidden.

Description: MULTI BAND SWIVEL MOUNT DIPOLE
698-960&1400-1700&1710-2690MHz

Series: Blade Antenna

PART NUMBER: W5095X

PACKAGING

1PCS/PE bag
100PCS/Carton box

W5095 Packing

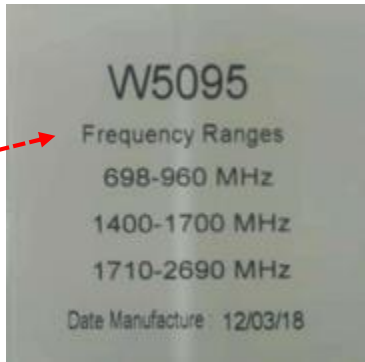

品名:	W5095
班别:	T班
数量:	100 PCS
WO:	1745424
箱号:	2018-11-26-08



Issue: 1849

In the effort to improve our products, we reserve the right to make changes judged to be necessary.

CONFIDENTIAL AND PROPRIETARY INFORMATION

This document contains confidential and proprietary information of Pulse Electronics, Inc. (Pulse) and is protected by copyright, trade secret and other state and federal laws. Its receipt or possession does not convey any rights to reproduce, disclose its contents, or to manufacture, use or sell anything it may describe. Reproduction, disclosure or use without specific written authorization of Pulse is strictly forbidden.

Description: MULTI BAND SWIVEL MOUNT DIPOLE
698-960&1400-1700&1710-2690MHz

Series: Blade Antenna

PART NUMBER: W5095X

PACKAGING

W5095K Packing

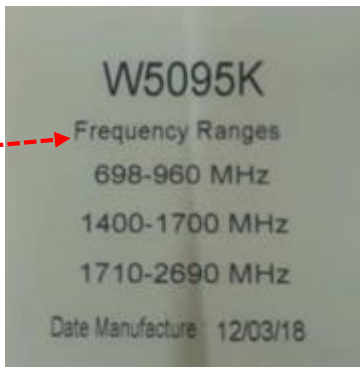

品名:	W5095K
班别:	T班
数量:	100 PCS
WO:	1745424
箱号:	2018-11-26-07



Issue: 1849

In the effort to improve our products, we reserve the right to make changes judged to be necessary.

CONFIDENTIAL AND PROPRIETARY INFORMATION

This document contains confidential and proprietary information of Pulse Electronics, Inc. (Pulse) and is protected by copyright, trade secret and other state and federal laws. Its receipt or possession does not convey any rights to reproduce, disclose its contents, or to manufacture, use or sell anything it may describe. Reproduction, disclosure or use without specific written authorization of Pulse is strictly forbidden.