

**Description:** Dual Feed GNSS/2.4GHz Ceramic

**Series:** Ceramic

**PART NUMBER:** W3064C

### Features:

- Omni directional radiation
- Low profile
- Compact size L x W x H (10 x 3.2 x 1.5 mm)
- Low weight (240 mg)
- Lead free materials
- Fully SMD compatible
- Lead free soldering compatible
- Tape and reel packing
- RoHS Compliant Product
- Flexible mounting orientation due to symmetrical pad layout

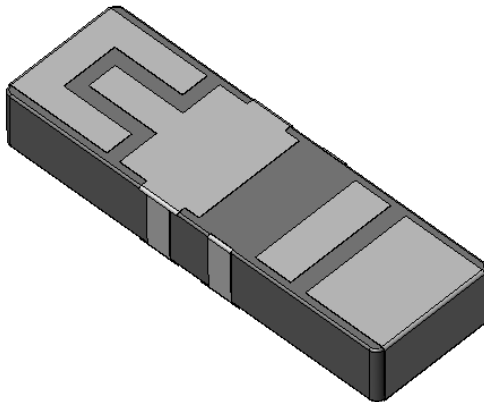

### Applications:

- GNSS L1 Band
- GPS L1 band (1.575 GHz)
- Bluetooth, WLAN, WiFi (2.4GHz – 2.483GHz)

All dimensions are in mm

Issue: 2049

In the effort to improve our products, we reserve the right to make changes judged to be necessary.

CONFIDENTIAL AND PROPRIETARY INFORMATION

This document contains confidential and proprietary information of Pulse Electronics, Inc. (Pulse) and is protected by copyright, trade secret and other state and federal laws. Its receipt or possession does not convey any rights to reproduce, disclose its contents, or to manufacture, use or sell anything it may describe. Reproduction, disclosure or use without specific written authorization of Pulse is strictly forbidden.

For more information:

Pulse Worldwide Headquarters  
15255 Innovation Drive #100  
San Diego, CA 92128  
USA  
Tel: 1-858-674-8100

Pulse/Larsen Antennas  
18110 SE 34<sup>th</sup> St Bldg 2 Suite 250  
Vancouver, WA 98683  
USA  
Tel: 1-360-944-7551

Europe Headquarters  
Pulse GmbH & Do, KG  
Zeppelinstrasse 15  
Herrenberg, Germany  
Tel: 49 7032 7806 0

Pulse (Suzhou) Wireless Products Co, Inc.  
99 Huo Ju Road(#29 Bldg,4<sup>th</sup> Phase  
Suzhou New District  
Jiangsu Province, Suzhou 215009 PR China  
Tel: 86 512 6807 9998



**Description:** Dual Feed GNSS/2.4GHz Ceramic

**Series:** Ceramic

**PART NUMBER:** W3064C

### ELECTRICAL SPECIFICATIONS

Frequency	1575.42+/-1MHz 2400-2483.5MHz
Nominal Impedance	50 $\Omega$
VSWR	2:1
Port-to-Port Isolation	-20dB
Radiation Pattern	Omni
Peak Gain	-1dBi @1575.42MHz -0.5dBi @2400-2483.5MHz
Efficiency	70% @1575.42MHz 70% @2400-2483.5MHz
Polarization	Linear
Power Withstanding	5W

Issue: 2049

In the effort to improve our products, we reserve the right to make changes judged to be necessary.

CONFIDENTIAL AND PROPRIETARY INFORMATION

This document contains confidential and proprietary information of Pulse Electronics, Inc. (Pulse) and is protected by copyright, trade secret and other state and federal laws. Its receipt or possession does not convey any rights to reproduce, disclose its contents, or to manufacture, use or sell anything it may describe. Reproduction, disclosure or use without specific written authorization of Pulse is strictly forbidden.

**Description:** Dual Feed GNSS/2.4GHz Ceramic

**Series:** Ceramic

**PART NUMBER:** W3064C

## MECHANICAL SPECIFICATIONS

Overall size	10*3.2*1.5 mm
Weight	240 mg

## ENVIRONMENTAL SPECIFICATIONS

Operating Temperature	-40~+85 ° C
Storage Temperature	-40~+85 ° C
RoHS Compliant	Yes
MSL level	1

**Description:** Dual Feed GNSS/2.4GHz Ceramic

**Series:** Ceramic

**PART NUMBER:** W3064C

### MECHANICAL DRAWING

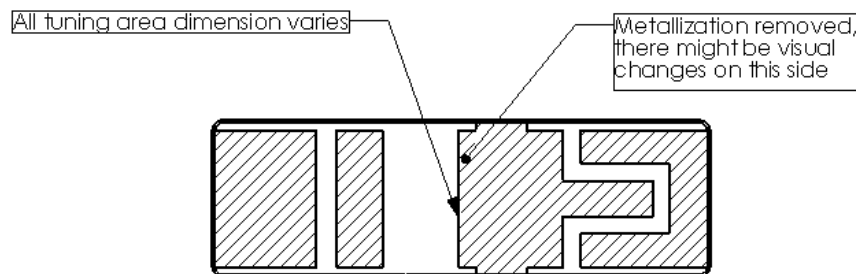
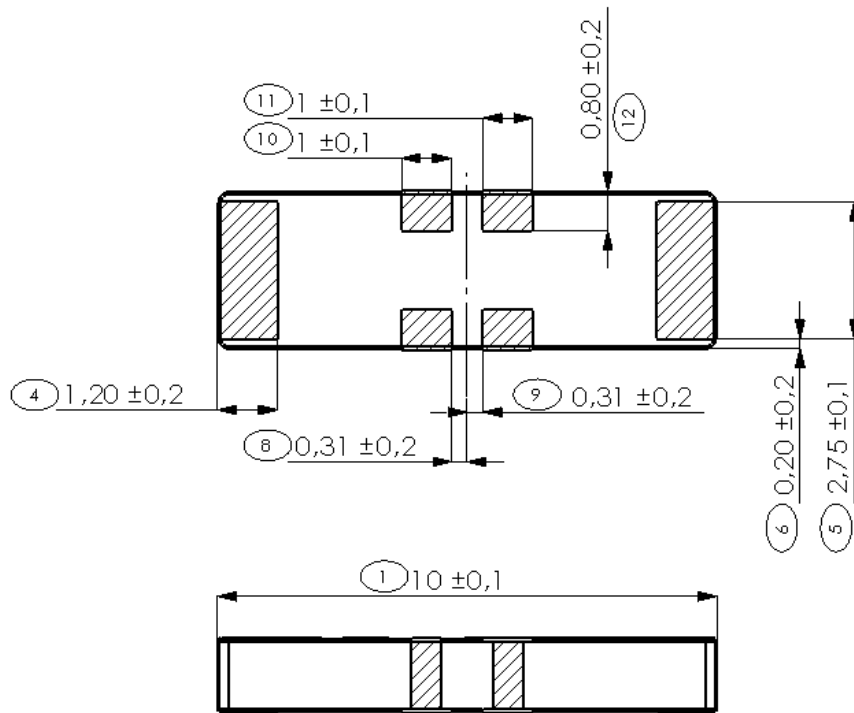

No.	Terminal Name	Terminal Dimensions
1	Feed BT / GND	1.20 x 2.75 mm
2	Feed GNSS / GND	1.20 x 2.75 mm

Issue: 2049

In the effort to improve our products, we reserve the right to make changes judged to be necessary.

CONFIDENTIAL AND PROPRIETARY INFORMATION

This document contains confidential and proprietary information of Pulse Electronics, Inc. (Pulse) and is protected by copyright, trade secret and other state and federal laws. Its receipt or possession does not convey any rights to reproduce, disclose its contents, or to manufacture, use or sell anything it may describe. Reproduction, disclosure or use without specific written authorization of Pulse is strictly forbidden.

**Description:** Dual Feed GNSS/2.4GHz Ceramic

**Series:** Ceramic

**PART NUMBER:** W3064C

## MECHANICAL DRAWING

### Test Setup for Electrical Measurements

*Recommended test board- layout for electrical characteristic measurement*

- Test board size 96 mm x 45 mm, PWB ground removal area 10.8 mm x 6.4 mm.
- GNSS antenna matching is done with 8.2nH shunt inductor, for Bluetooth a 1.0pF shunt capacitor is used.

*3D- view of Test Setup*

- Test Setup: Antenna Positioned to the side-center location of test PCB 96mm long edge

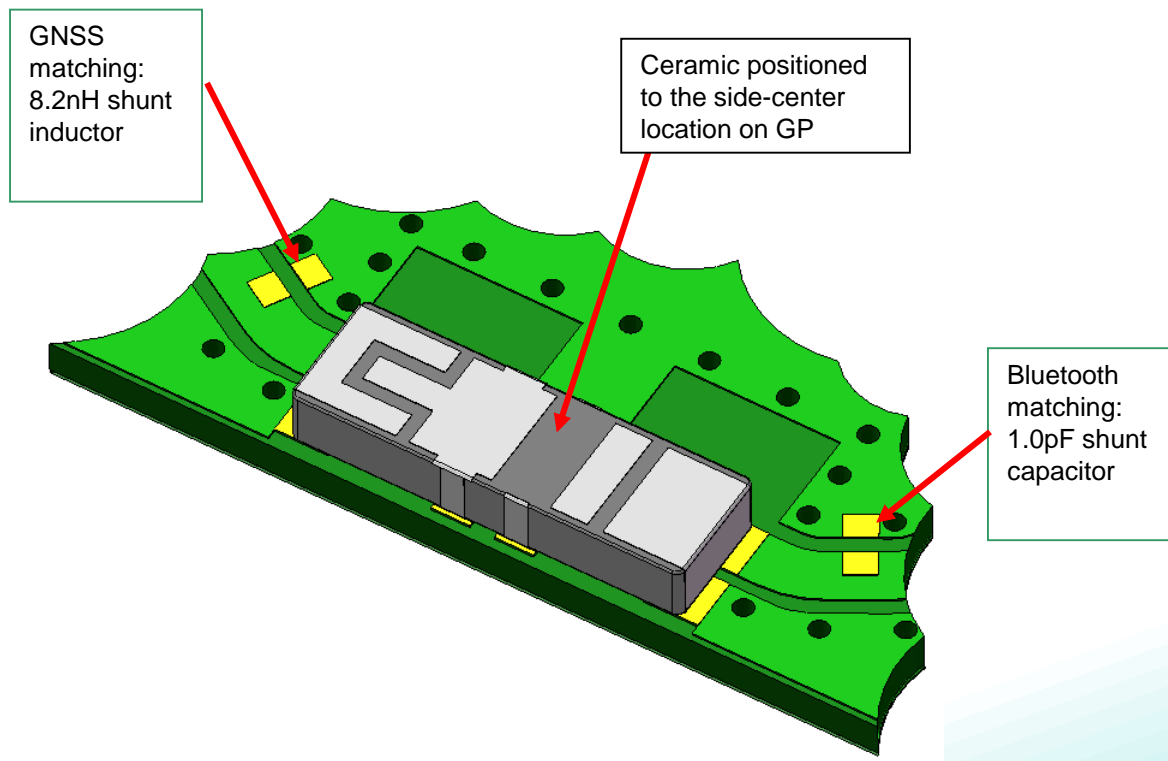

Issue: 2049

In the effort to improve our products, we reserve the right to make changes judged to be necessary.

CONFIDENTIAL AND PROPRIETARY INFORMATION

This document contains confidential and proprietary information of Pulse Electronics, Inc. (Pulse) and is protected by copyright, trade secret and other state and federal laws. Its receipt or possession does not convey any rights to reproduce, disclose its contents, or to manufacture, use or sell anything it may describe. Reproduction, disclosure or use without specific written authorization of Pulse is strictly forbidden.

## MECHANICAL DRAWING

### W3064C Layout information

Ground Cleared Under Antenna. Ground removal area under antenna 10.8 mm x 6.4 mm.

### Terminal Configuration

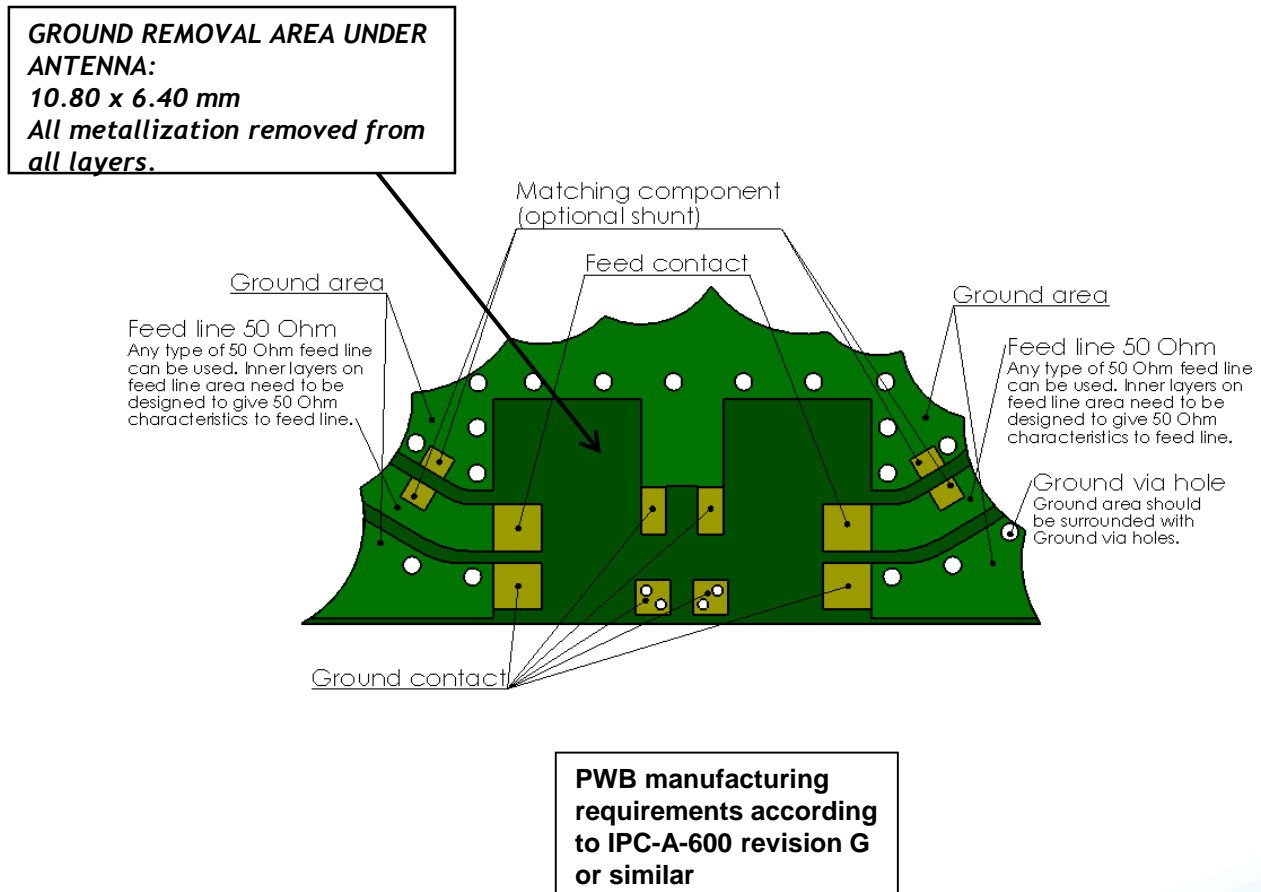

MECHANICAL DRAWING

Recommended Antenna Pad Dimensions on PWB Layout (Top surface)

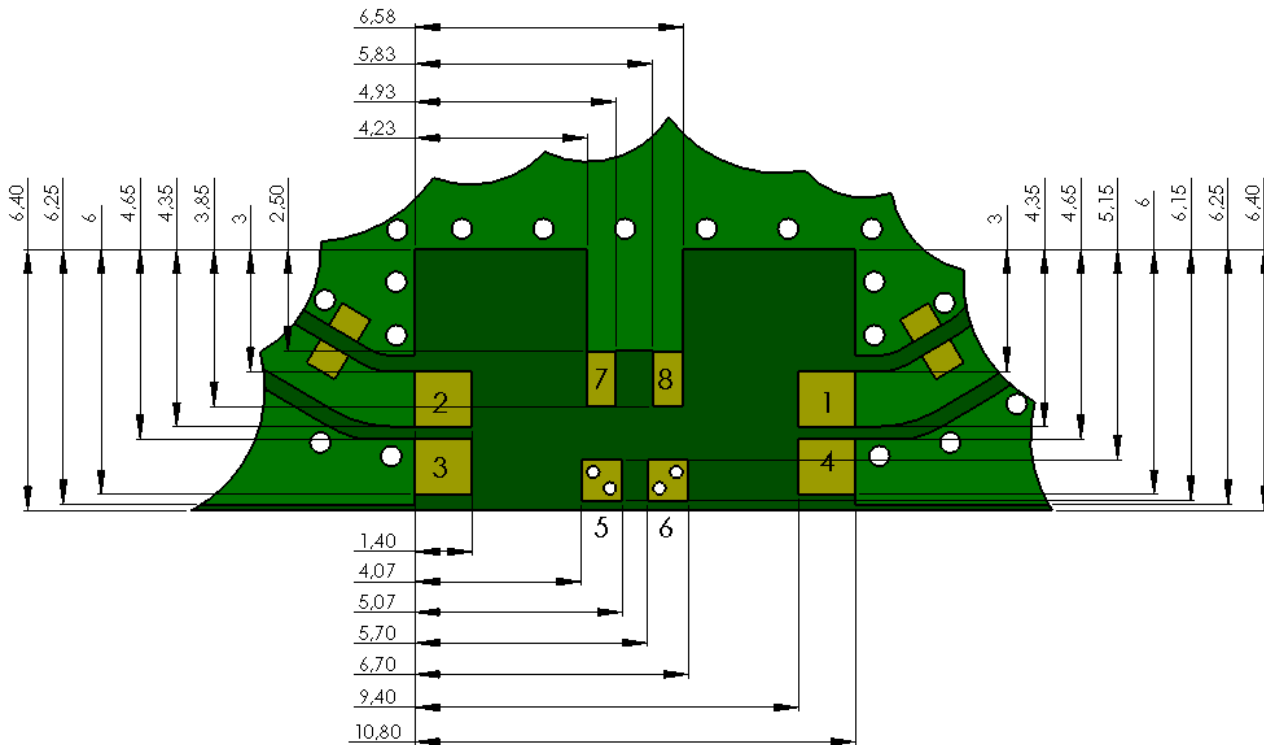

PWB features		
No.	Terminal Name	Terminal Dimensions
1	Feed BT/GNSS*	1.35 x 1.40 mm
2	Feed GNSS/BT*	1.35 x 1.40 mm
3	GND	1.35 x 1.40 mm
4	GND	1.35 x 1.40 mm
5	GND	1.00 x 1.00 mm
6	GND	1.00 x 1.00 mm
7	GND	1.35 x 0.70 mm
8	GND	1.35 x 0.75 mm

**\*Antenna orientation can be rotated freely by 180 degrees because of the symmetrical pad layout.**

**Description:** Dual Feed GNSS/2.4GHz Ceramic

**Series:** Ceramic

**PART NUMBER:** W3064C

## MECHANICAL DRAWING

### Recommended Antenna Dimensions on PWB Layout (Bottom surface)

Ground Cleared Under Antenna. Ground removal area under antenna 10.8 mm x 6.4 mm.

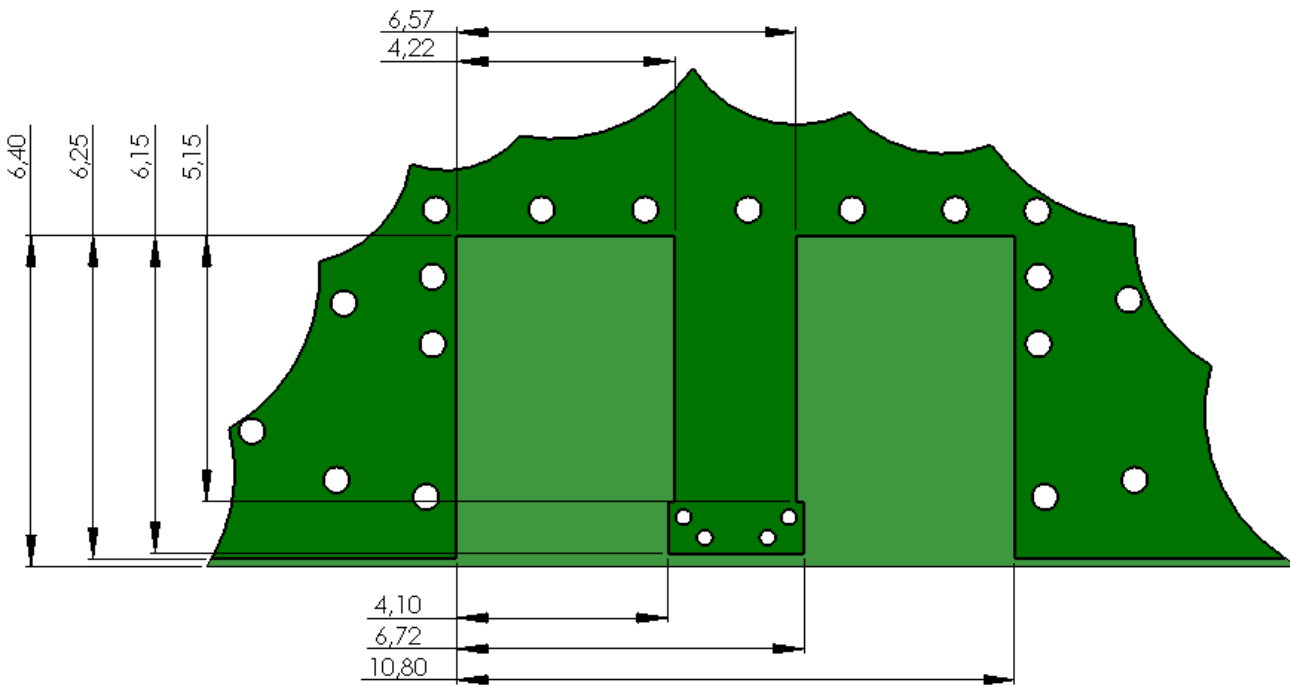

Issue: 2049

In the effort to improve our products, we reserve the right to make changes judged to be necessary.

CONFIDENTIAL AND PROPRIETARY INFORMATION

This document contains confidential and proprietary information of Pulse Electronics, Inc. (Pulse) and is protected by copyright, trade secret and other state and federal laws. Its receipt or possession does not convey any rights to reproduce, disclose its contents, or to manufacture, use or sell anything it may describe. Reproduction, disclosure or use without specific written authorization of Pulse is strictly forbidden.



Description: Dual Feed GNSS/2.4GHz Ceramic

Series: Ceramic

PART NUMBER: W3064C

CHARTS

GPS Return Loss

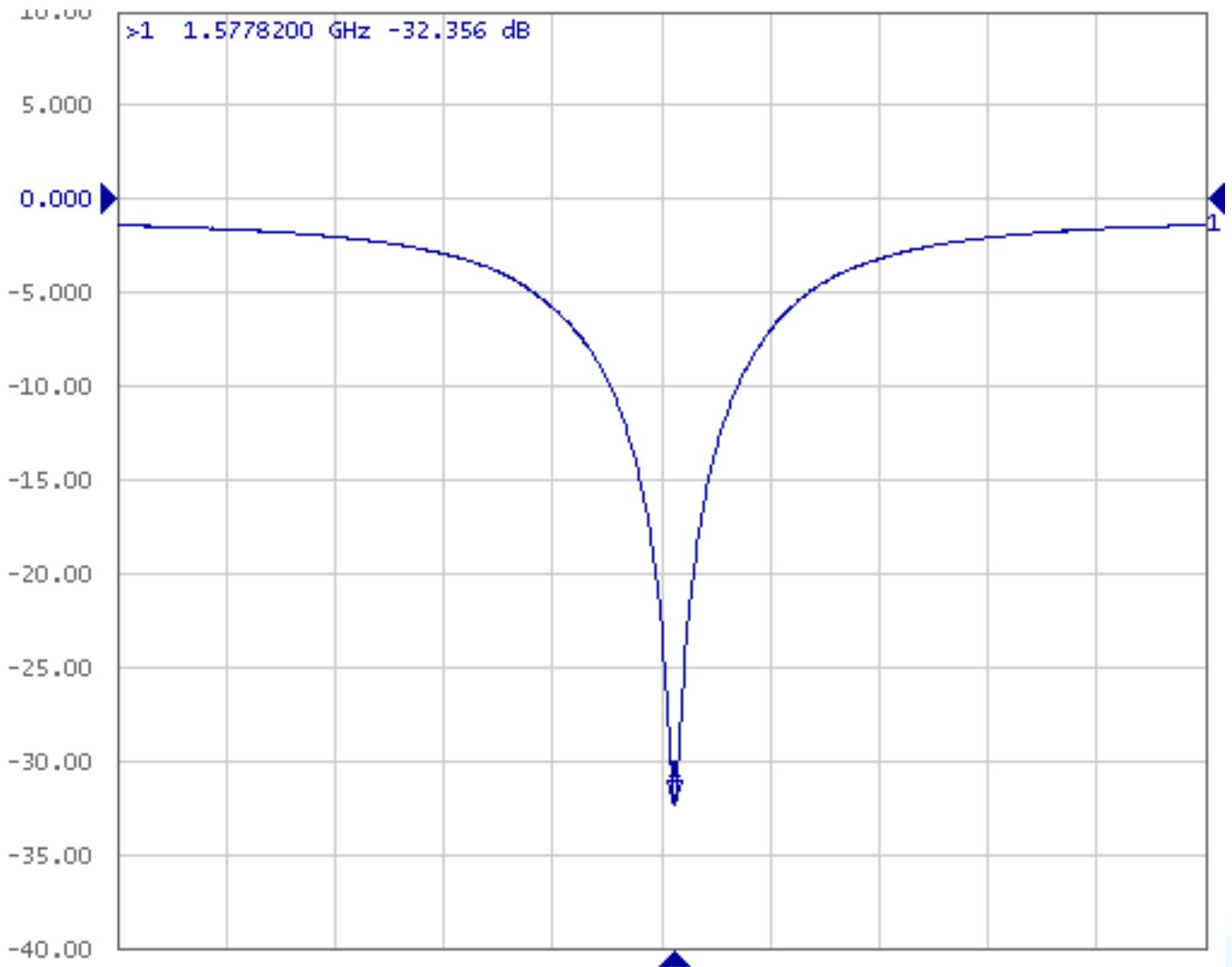

Issue: 2049

In the effort to improve our products, we reserve the right to make changes judged to be necessary.

CONFIDENTIAL AND PROPRIETARY INFORMATION

This document contains confidential and proprietary information of Pulse Electronics, Inc. (Pulse) and is protected by copyright, trade secret and other state and federal laws. Its receipt or possession does not convey any rights to reproduce, disclose its contents, or to manufacture, use or sell anything it may describe. Reproduction, disclosure or use without specific written authorization of Pulse is strictly forbidden.

Description: Dual Feed GNSS/2.4GHz Ceramic

Series: Ceramic

PART NUMBER: W3064C

### CHARTS

#### BT Return Loss

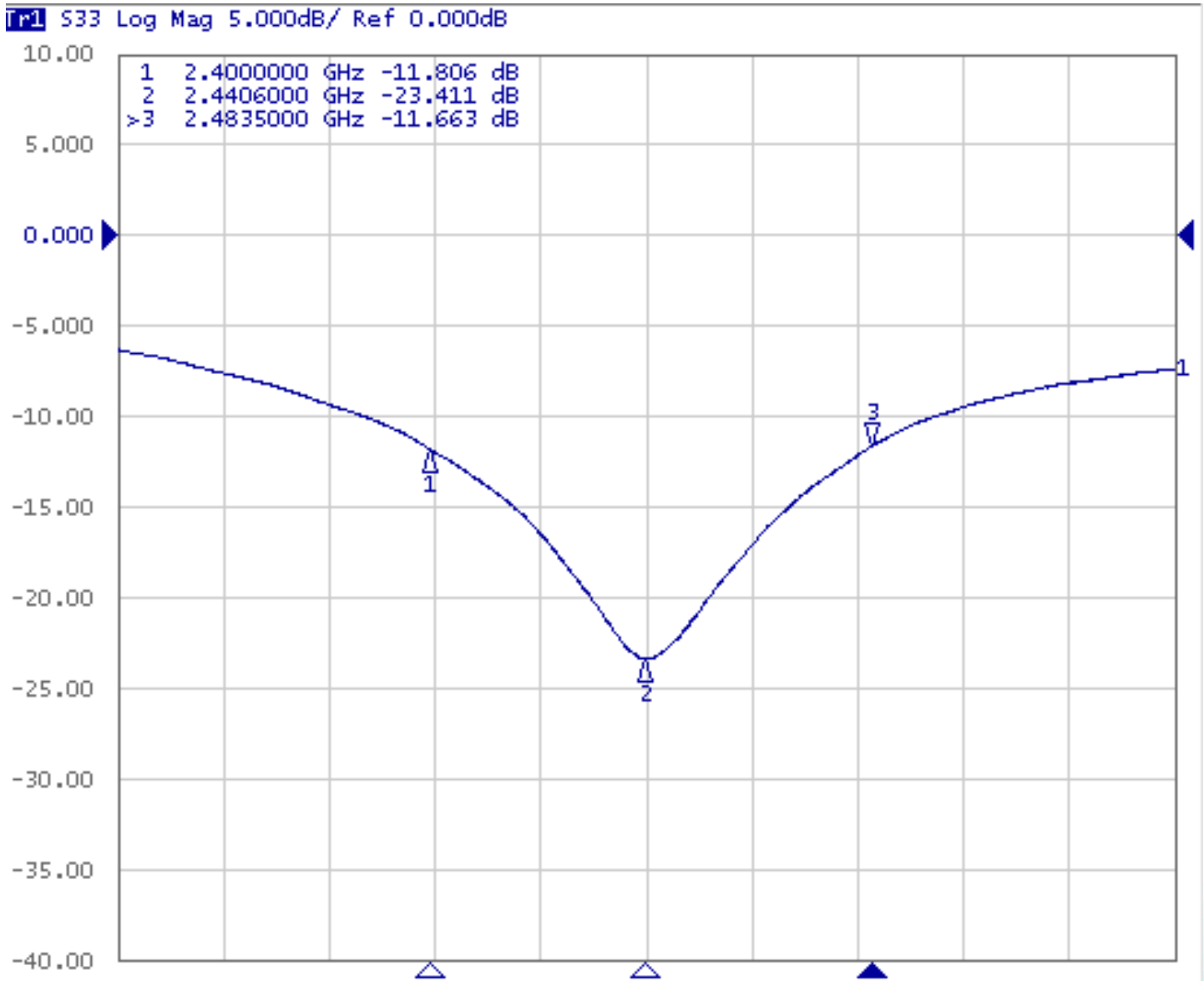

Issue: 2049

In the effort to improve our products, we reserve the right to make changes judged to be necessary.

CONFIDENTIAL AND PROPRIETARY INFORMATION

This document contains confidential and proprietary information of Pulse Electronics, Inc. (Pulse) and is protected by copyright, trade secret and other state and federal laws. Its receipt or possession does not convey any rights to reproduce, disclose its contents, or to manufacture, use or sell anything it may describe. Reproduction, disclosure or use without specific written authorization of Pulse is strictly forbidden.

## CHARTS

### Isolation Between GPS And BT

▶ S34 Log Mag 5.000dB/ Ref 0.000dB

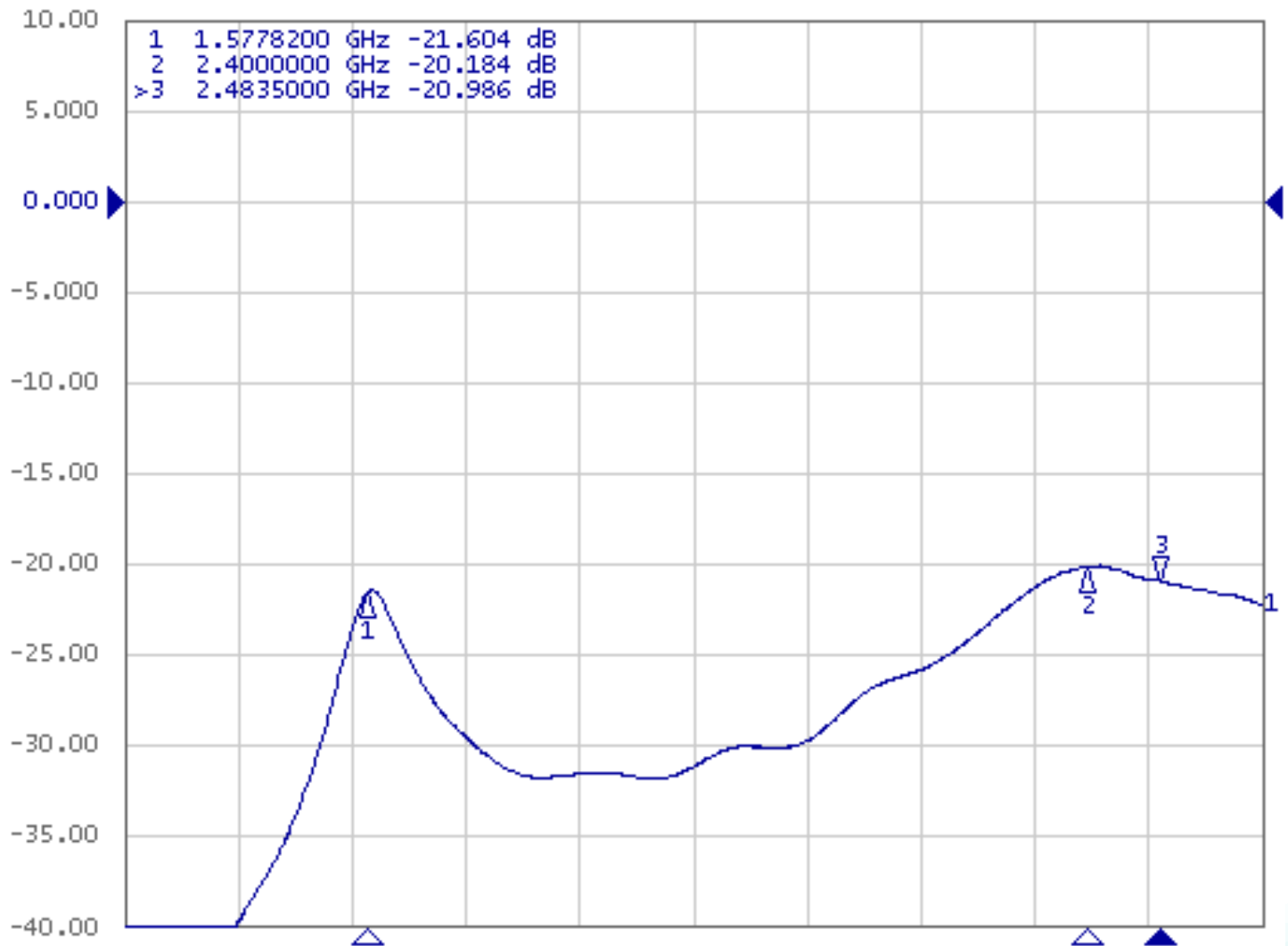

Description: Dual Feed GNSS/2.4GHz Ceramic

Series: Ceramic

PART NUMBER: W3064C

## CHARTS

### Efficiency

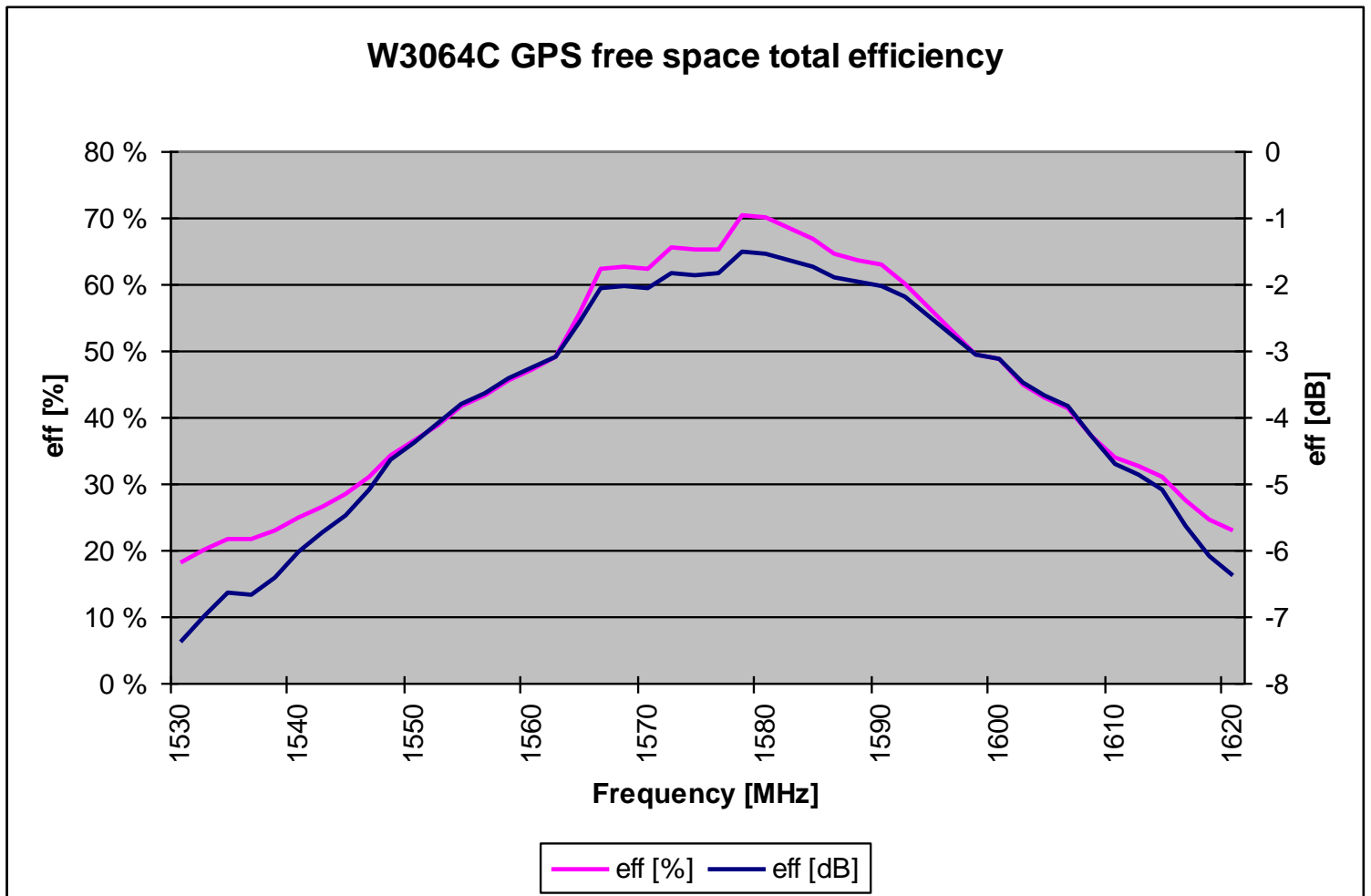

Issue: 2049

In the effort to improve our products, we reserve the right to make changes judged to be necessary.

CONFIDENTIAL AND PROPRIETARY INFORMATION

This document contains confidential and proprietary information of Pulse Electronics, Inc. (Pulse) and is protected by copyright, trade secret and other state and federal laws. Its receipt or possession does not convey any rights to reproduce, disclose its contents, or to manufacture, use or sell anything it may describe. Reproduction, disclosure or use without specific written authorization of Pulse is strictly forbidden.

Description: Dual Feed GNSS/2.4GHz Ceramic

Series: Ceramic

PART NUMBER: W3064C

## CHARTS

### Efficiency

W3064C BT total antenna efficiency

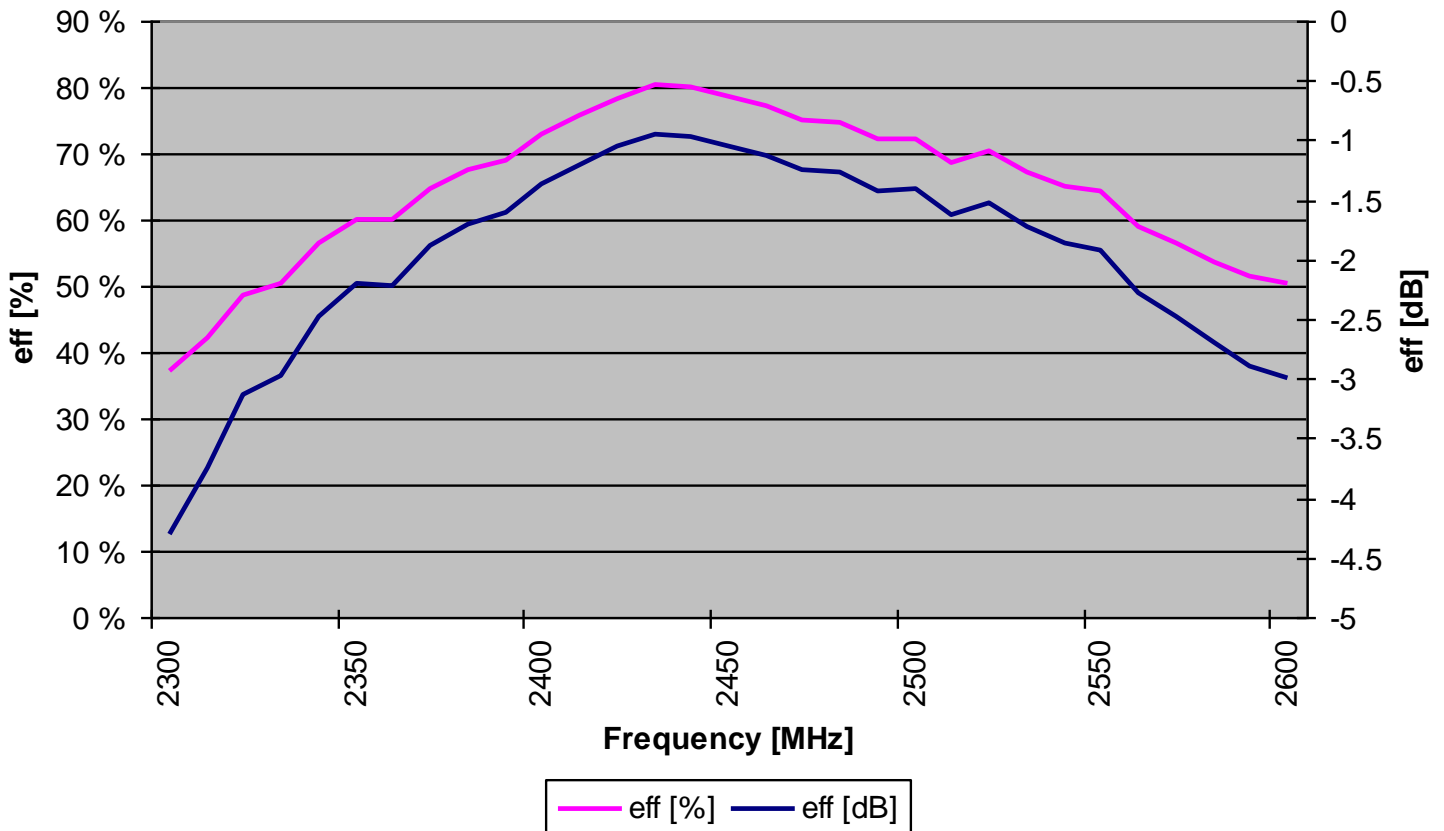

Description: Dual Feed GNSS/2.4GHz Ceramic

Series: Ceramic

PART NUMBER: W3064C

## CHARTS

### Peak Gain(dBi)

W3064C GPS antenna gain [dBi]

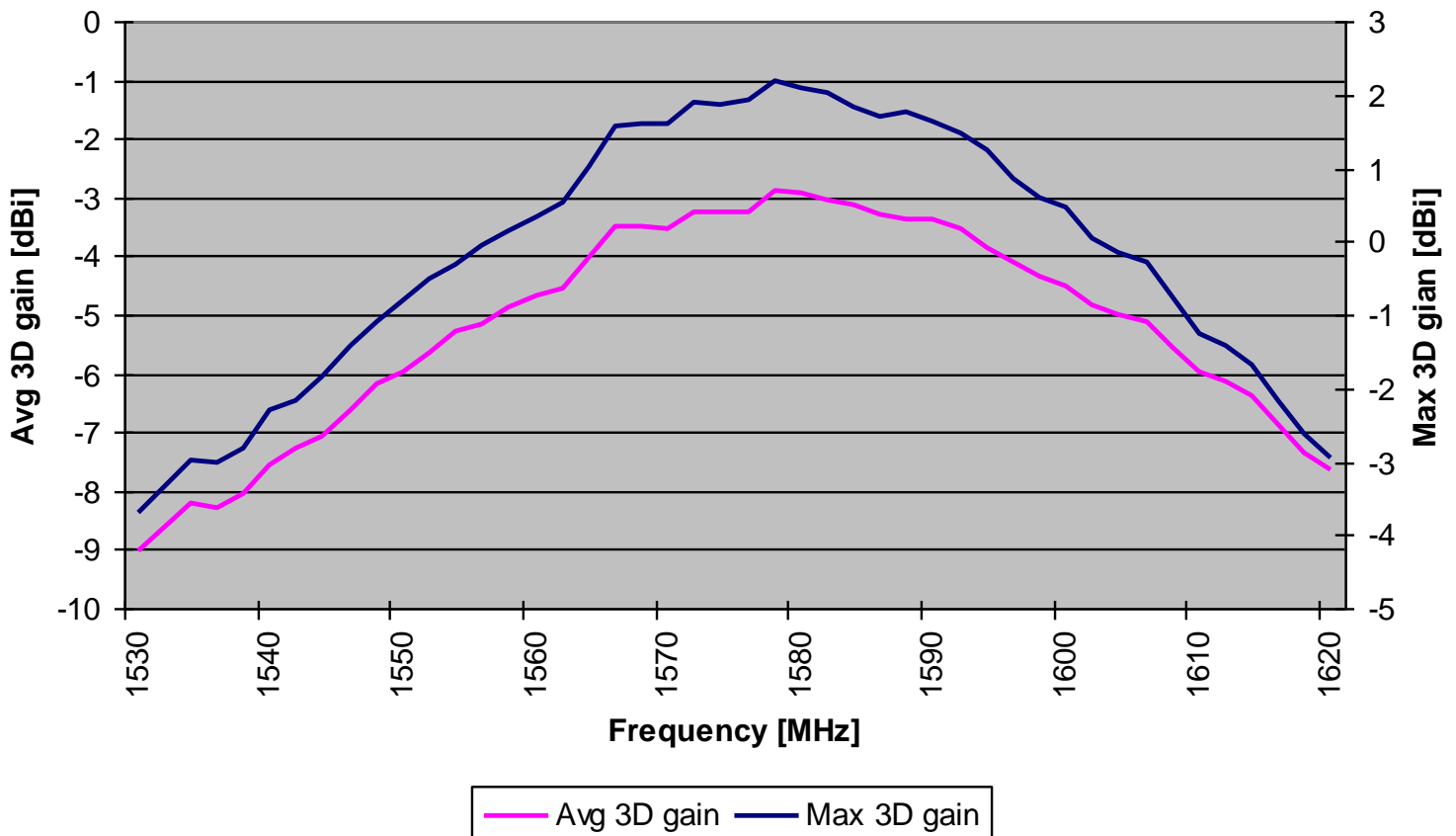

Description: Dual Feed GNSS/2.4GHz Ceramic

Series: Ceramic

PART NUMBER: W3064C

## CHARTS

### Peak Gain(dBi)

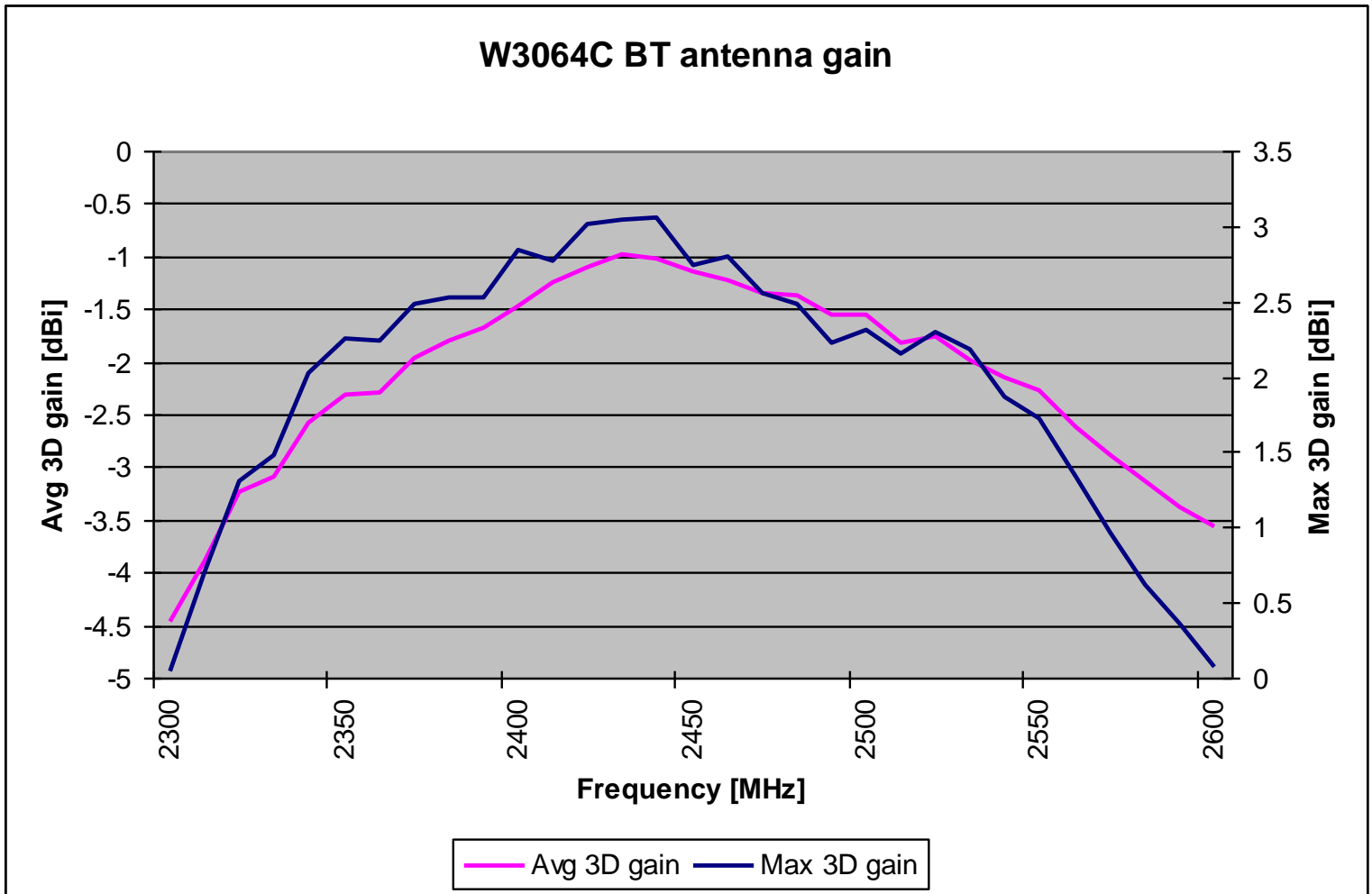

**Description:** Dual Feed GNSS/2.4GHz Ceramic

**Series:** Ceramic

**PART NUMBER:** W3064C

## CHARTS

### Free Space Radiation Pattern

1575MHz

#### Elevation Plane

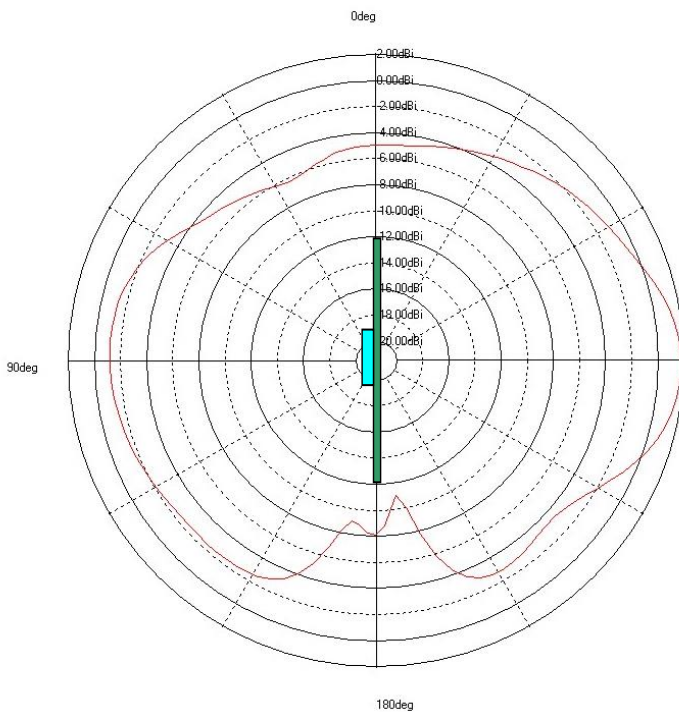

#### Horizontal Plane

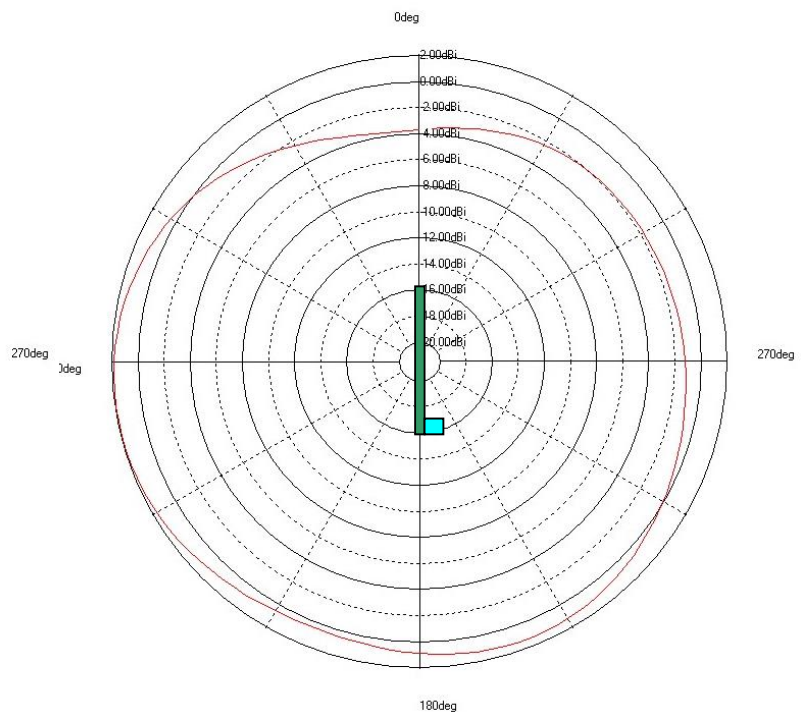

Issue: 2049

In the effort to improve our products, we reserve the right to make changes judged to be necessary.

CONFIDENTIAL AND PROPRIETARY INFORMATION

This document contains confidential and proprietary information of Pulse Electronics, Inc. (Pulse) and is protected by copyright, trade secret and other state and federal laws. Its receipt or possession does not convey any rights to reproduce, disclose its contents, or to manufacture, use or sell anything it may describe. Reproduction, disclosure or use without specific written authorization of Pulse is strictly forbidden.



**Description:** Dual Feed GNSS/2.4GHz Ceramic

**Series:** Ceramic

**PART NUMBER:** W3064C

## CHARTS

### Free Space Radiation Pattern

2400MHz 2440MHz 2480MHz

#### Elevation Plane

#### Horizontal Plane

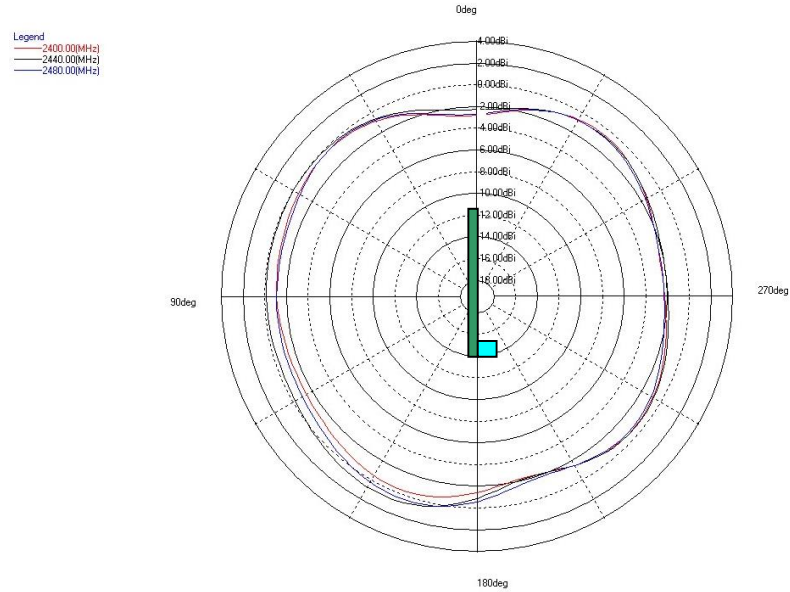
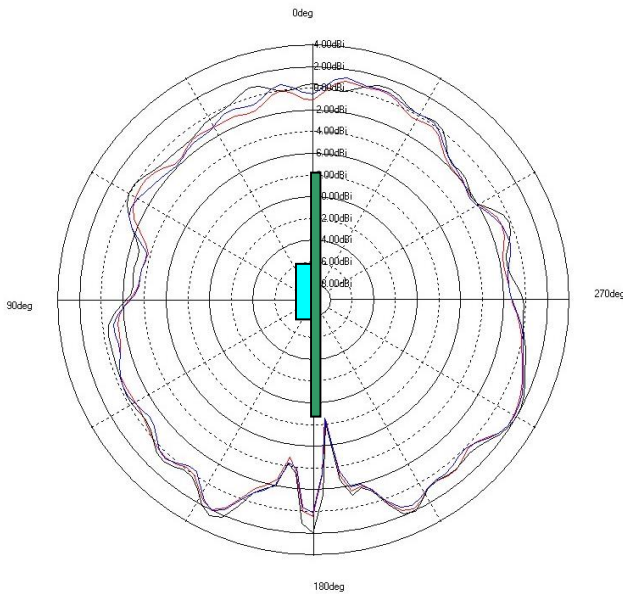

Issue: 2049

In the effort to improve our products, we reserve the right to make changes judged to be necessary.

CONFIDENTIAL AND PROPRIETARY INFORMATION

This document contains confidential and proprietary information of Pulse Electronics, Inc. (Pulse) and is protected by copyright, trade secret and other state and federal laws. Its receipt or possession does not convey any rights to reproduce, disclose its contents, or to manufacture, use or sell anything it may describe. Reproduction, disclosure or use without specific written authorization of Pulse is strictly forbidden.

**Description:** Dual Feed GNSS/2.4GHz Ceramic

**Series:** Ceramic

**PART NUMBER:** W3064C

### PACKAGING

#### General

Tape and reel packing is used. Carrier tape, reel and box dimensions are presented in following pictures. 1K Antenna per Reel, 2K Antenna per Inbox, 6K Antenna per Outbox

#### Carrier tape

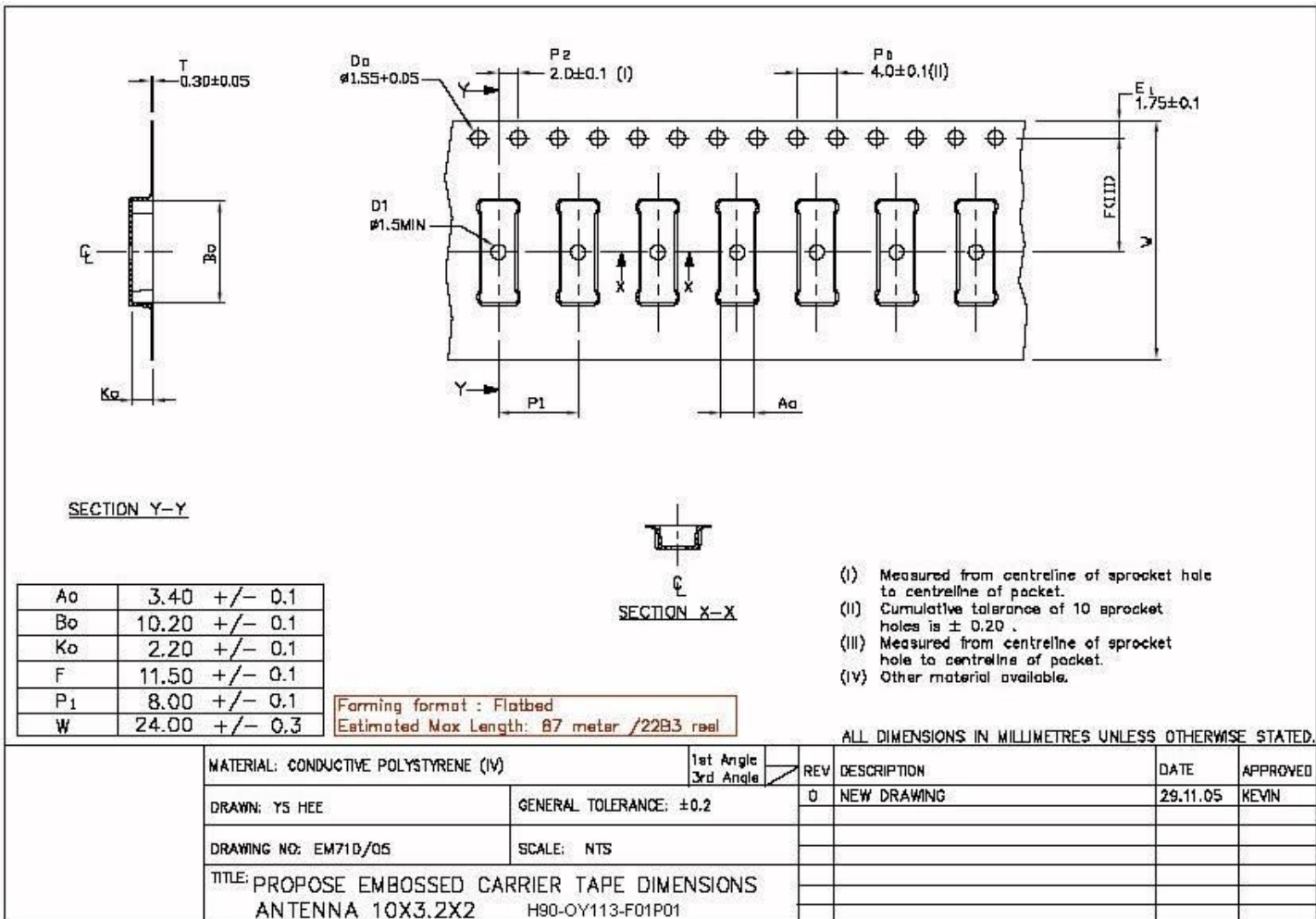

Issue: 2049

In the effort to improve our products, we reserve the right to make changes judged to be necessary.

CONFIDENTIAL AND PROPRIETARY INFORMATION

This document contains confidential and proprietary information of Pulse Electronics, Inc. (Pulse) and is protected by copyright, trade secret and other state and federal laws. Its receipt or possession does not convey any rights to reproduce, disclose its contents, or to manufacture, use or sell anything it may describe. Reproduction, disclosure or use without specific written authorization of Pulse is strictly forbidden.

**Description:** Dual Feed GNSS/2.4GHz Ceramic

**Series:** Ceramic

**PART NUMBER:** W3064C

**PACKAGING**

Top view of the carrier tape

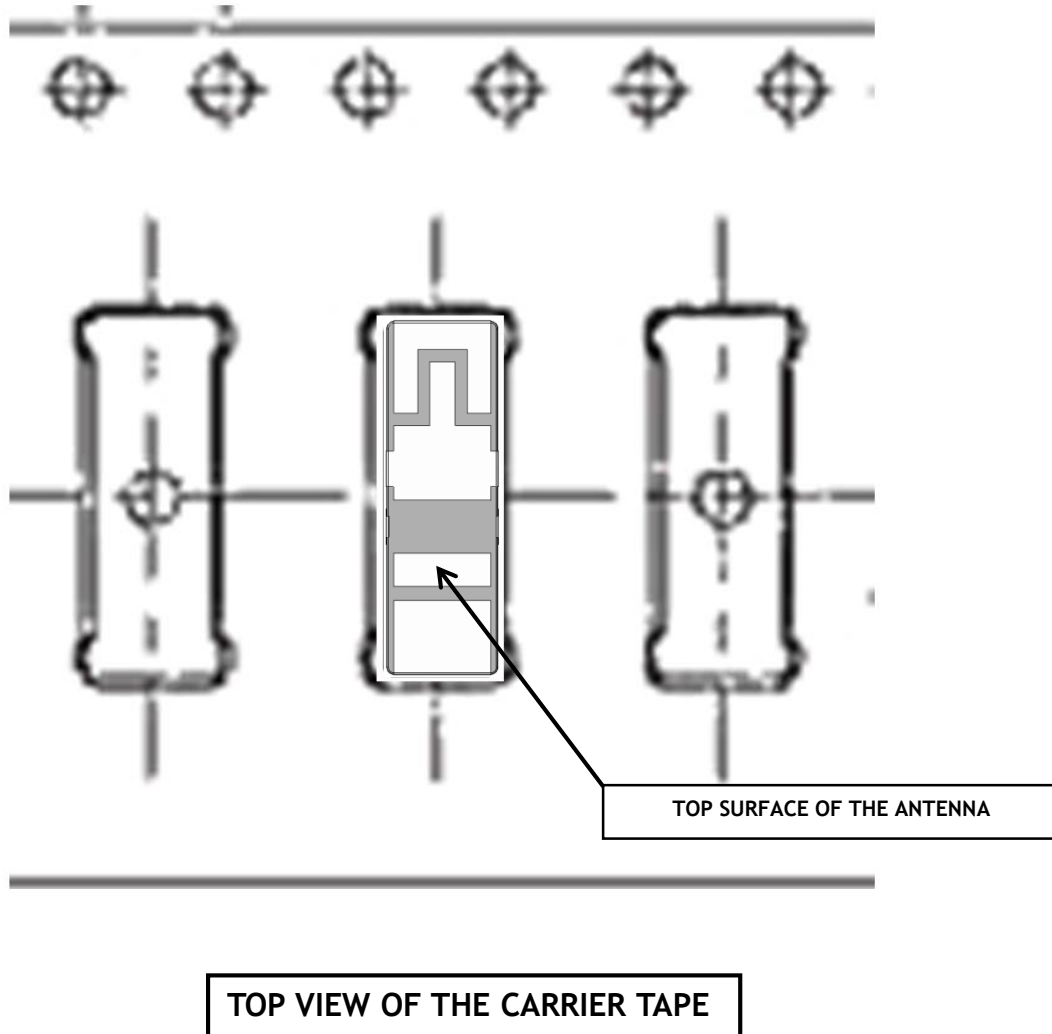

**Description:** Dual Feed GNSS/2.4GHz Ceramic

**Series:** Ceramic

**PART NUMBER:** W3064C

### PACKAGING

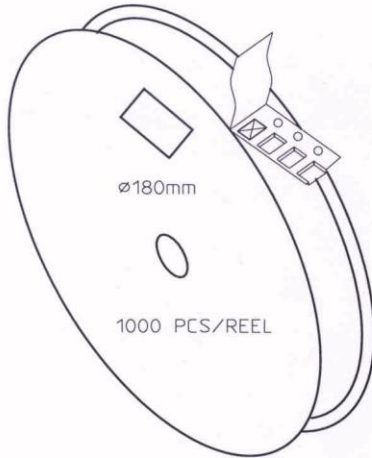

CARRIER TAPE H85-00188  
width=24,00 depth=2.20  
COVER TAPE H85-00159  
width=21.20

LENGTH OF TAPE:

- Leader section: min 350 mm before component section
- Trailer section: min 40 mm after component section.

Empty part cavities at leader and trailer section of the tape must be sealed with top cover tape.

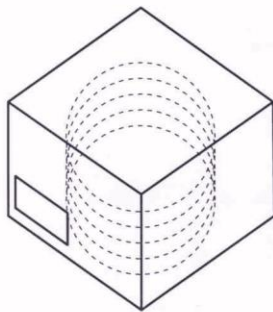

- BOX H85-00128 (182x182x125) 1 pcs
- LABEL 1 pcs/BOX
- REEL H85-00160 (D180,W28) 4 pcs
- REEL LABEL 1 pcs/REEL

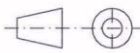
MATERIAL									
HANDLINGS									
		RATIO	DRWN	160107	PeHa	H			
			DGNER				G		
			CHKD					F	
			APPRD					E	
PRODUCT		H90-OY113-F01P01		APPRD BY		D			
DENOMINATION		PACKING FORM				C			
						B			
						A			
		VERSION		MOD/DATE/NAME					

Issue: 2049

In the effort to improve our products, we reserve the right to make changes judged to be necessary.

CONFIDENTIAL AND PROPRIETARY INFORMATION

This document contains confidential and proprietary information of Pulse Electronics, Inc. (Pulse) and is protected by copyright, trade secret and other state and federal laws. Its receipt or possession does not convey any rights to reproduce, disclose its contents, or to manufacture, use or sell anything it may describe. Reproduction, disclosure or use without specific written authorization of Pulse is strictly forbidden.