

SRS1 Series

Single-Phase, Socket Type SSR

■ Features

- Socket type for easier installation and maintenance
 - SRS1-A: Autonics socket SK-G05 (AC, DC, AC/DC)
 - SRS1-B: Universal LY2 sockets (AC)
 - SRS1-C: Universal MY4 sockets (AC, DC, AC/DC)
- Dielectric strength: 2500 VAC
- Zero cross turn-on, random turn-on models available
- Input indicator (red LED)



SRS1-A

SRS1-B



SRS1-C

 Please read "Safety Considerations" in the instruction manual before using.



■ Ordering Information

SRS	1	-	B	1	2	02	R	-	2																																																																																																														
<table border="0" style="width: 100%; border-collapse: collapse;"> <tr> <td style="width: 10%;"></td> <td style="width: 10%;"></td> <td style="width: 10%;"></td> <td style="width: 10%;"></td> <td style="width: 10%;"></td> <td style="width: 10%;"></td> <td style="width: 10%;"></td> <td style="width: 10%;"></td> <td style="width: 10%;"></td> <td style="width: 10%;"></td> </tr> <tr> <td style="border: none;">Item</td> <td style="border: none;">Control phase</td> <td style="border: none;">Socket</td> <td style="border: none;">Rated input voltage</td> <td style="border: none;">Rated load voltage</td> <td style="border: none;">Rated load current (resistive load)</td> <td style="border: none;">Function</td> <td style="border: none;">Number of output circuits</td> <td style="border: none;"></td> <td style="border: none;"></td> </tr> </table>																				Item	Control phase	Socket	Rated input voltage	Rated load voltage	Rated load current (resistive load)	Function	Number of output circuits																																																																																												
Item	Control phase	Socket	Rated input voltage	Rated load voltage	Rated load current (resistive load)	Function	Number of output circuits																																																																																																																
<table border="0" style="width: 100%; border-collapse: collapse;"> <tr> <td style="width: 10%;"></td> <td style="width: 10%;"></td> <td style="width: 10%;"></td> <td style="width: 10%;"></td> <td style="width: 10%;"></td> <td style="width: 10%;"></td> <td style="width: 10%;"></td> <td style="width: 10%;"></td> <td style="width: 10%;"></td> <td style="width: 10%;"></td> </tr> <tr> <td style="border: none;">SRS1-A</td> <td style="border: none;">SRS1-B</td> <td style="border: none;">SRS1-C</td> <td style="border: none;">SRS1-A</td> <td style="border: none;">SRS1-B, SRS1-C</td> <td style="border: none;">SRS1-A</td> <td style="border: none;">SRS1-B</td> <td style="border: none;">SRS1-C</td> <td style="border: none;">SRS1-A</td> <td style="border: none;">SRS1-B, SRS1-C</td> </tr> </table>																				SRS1-A	SRS1-B	SRS1-C	SRS1-A	SRS1-B, SRS1-C	SRS1-A	SRS1-B	SRS1-C	SRS1-A	SRS1-B, SRS1-C																																																																																										
SRS1-A	SRS1-B	SRS1-C	SRS1-A	SRS1-B, SRS1-C	SRS1-A	SRS1-B	SRS1-C	SRS1-A	SRS1-B, SRS1-C																																																																																																														
<table border="1" style="width: 100%; border-collapse: collapse;"> <tr> <td style="width: 10%;"></td> <td style="width: 10%;"></td> <td style="width: 10%;"></td> <td style="width: 10%;"></td> <td style="width: 10%;"></td> <td style="width: 10%;"></td> <td style="width: 10%;"></td> <td style="width: 10%;"></td> <td style="width: 10%;"></td> <td style="width: 10%;"></td> </tr> <tr> <td style="border: none;">1</td> <td style="border: none;">1</td> <td style="border: none;">2</td> <td style="border: none;">No mark</td> <td style="border: none;">Zero cross turn-on</td> <td style="border: none;">01</td> <td style="border: none;">1A</td> <td style="border: none;">2</td> <td style="border: none;">24-240VAC</td> <td style="border: none;">SRS1-A</td> </tr> <tr> <td style="border: none;">2</td> <td style="border: none;">2</td> <td style="border: none;">D1</td> <td style="border: none;">R</td> <td style="border: none;">Random turn-on</td> <td style="border: none;">02</td> <td style="border: none;">2A</td> <td style="border: none;">D2</td> <td style="border: none;">5-100VDC</td> <td style="border: none;">SRS1-B</td> </tr> <tr> <td style="border: none;">03</td> <td style="border: none;">3A</td> <td style="border: none;">X2</td> <td style="border: none;">2</td> <td style="border: none;">90-240VAC</td> <td style="border: none;">05</td> <td style="border: none;">5A</td> <td style="border: none;">D1</td> <td style="border: none;">5-200VDC</td> <td style="border: none;">SRS1-C</td> </tr> <tr> <td style="border: none;">05</td> <td style="border: none;">5A</td> <td style="border: none;">2</td> <td style="border: none;">2</td> <td style="border: none;">90-240VAC</td> <td style="border: none;"></td> <td style="border: none;"></td> <td style="border: none;">X2</td> <td style="border: none;">5-240VAC/5-200VDC (universal)</td> <td style="border: none;">SRS1-A</td> </tr> <tr> <td style="border: none;"></td> <td style="border: none;"></td> <td style="border: none;">D1</td> <td style="border: none;">2</td> <td style="border: none;">90-240VAC</td> <td style="border: none;"></td> <td style="border: none;"></td> <td style="border: none;">2</td> <td style="border: none;">5-100VDC</td> <td style="border: none;">SRS1-B, SRS1-C</td> </tr> <tr> <td style="border: none;"></td> <td style="border: none;"></td> <td style="border: none;">X2</td> <td style="border: none;">2</td> <td style="border: none;">90-240VAC</td> <td style="border: none;"></td> <td style="border: none;"></td> <td style="border: none;">1</td> <td style="border: none;">4-24VDC</td> <td style="border: none;"></td> </tr> <tr> <td style="border: none;"></td> <td style="border: none;"></td> <td style="border: none;">2</td> <td style="border: none;">1</td> <td style="border: none;">4-24VDC</td> <td style="border: none;"></td> <td style="border: none;"></td> <td style="border: none;">1</td> <td style="border: none;">4-30VDC^{※1}</td> <td style="border: none;"></td> </tr> <tr> <td style="border: none;"></td> <td style="border: none;"></td> <td style="border: none;">D1</td> <td style="border: none;">A</td> <td style="border: none;">Autonics socket (Model: SK-G05)</td> <td style="border: none;"></td> <td style="border: none;"></td> <td style="border: none;">1</td> <td style="border: none;">Single-phase</td> <td style="border: none;"></td> </tr> <tr> <td style="border: none;"></td> <td style="border: none;"></td> <td style="border: none;">X2</td> <td style="border: none;">B</td> <td style="border: none;">Universal LY2 socket</td> <td style="border: none;"></td> <td style="border: none;"></td> <td style="border: none;">SRS</td> <td style="border: none;">Solid State Relay (socket type)</td> <td style="border: none;"></td> </tr> <tr> <td style="border: none;"></td> <td style="border: none;"></td> <td style="border: none;">2</td> <td style="border: none;">C</td> <td style="border: none;">Universal MY4 socket</td> <td style="border: none;"></td> <td style="border: none;"></td> <td style="border: none;"></td> <td style="border: none;"></td> <td style="border: none;"></td> </tr> </table>																				1	1	2	No mark	Zero cross turn-on	01	1A	2	24-240VAC	SRS1-A	2	2	D1	R	Random turn-on	02	2A	D2	5-100VDC	SRS1-B	03	3A	X2	2	90-240VAC	05	5A	D1	5-200VDC	SRS1-C	05	5A	2	2	90-240VAC			X2	5-240VAC/5-200VDC (universal)	SRS1-A			D1	2	90-240VAC			2	5-100VDC	SRS1-B, SRS1-C			X2	2	90-240VAC			1	4-24VDC				2	1	4-24VDC			1	4-30VDC ^{※1}				D1	A	Autonics socket (Model: SK-G05)			1	Single-phase				X2	B	Universal LY2 socket			SRS	Solid State Relay (socket type)				2	C	Universal MY4 socket					
1	1	2	No mark	Zero cross turn-on	01	1A	2	24-240VAC	SRS1-A																																																																																																														
2	2	D1	R	Random turn-on	02	2A	D2	5-100VDC	SRS1-B																																																																																																														
03	3A	X2	2	90-240VAC	05	5A	D1	5-200VDC	SRS1-C																																																																																																														
05	5A	2	2	90-240VAC			X2	5-240VAC/5-200VDC (universal)	SRS1-A																																																																																																														
		D1	2	90-240VAC			2	5-100VDC	SRS1-B, SRS1-C																																																																																																														
		X2	2	90-240VAC			1	4-24VDC																																																																																																															
		2	1	4-24VDC			1	4-30VDC ^{※1}																																																																																																															
		D1	A	Autonics socket (Model: SK-G05)			1	Single-phase																																																																																																															
		X2	B	Universal LY2 socket			SRS	Solid State Relay (socket type)																																																																																																															
		2	C	Universal MY4 socket																																																																																																																			

※1: In case of SRS1-C1D102-1, SRS1-C1X201-1, rated input voltage is 4-24VDC.

Single-Phase, Socket Type SSR

Model	Rated input voltage	Rated load current	Rated load voltage	Function	
SRS1-A	4-24VDC \equiv	2A	24-240VAC \sim	Zero cross turn-on	
				Random turn-on	
				Zero cross turn-on	
		3A		Random turn-on	
				Zero cross turn-on	
				5A	Random turn-on
		1A	5-100VDC \equiv		—
					2A
		1A	5-240VAC \sim /5-200VDC \equiv	—	
					SRS1-B
Random turn-on					
3A	Zero cross turn-on				
	Random turn-on				
5A	Zero cross turn-on				
	Random turn-on				
SRS1-C	4-30VDC \equiv	2A (consists of 2 circuits)	90-240VAC \sim	Zero cross turn-on	
				Random turn-on	
		3A		Zero cross turn-on	
				Random turn-on	
		5A		Zero cross turn-on	
				Random turn-on	
	4-24VDC \equiv	2A	5-100VDC \equiv	—	
					1A

Specifications

Input

Series	SRS1-A	SRS1-B	SRS1-C1202(R)-2/ SRS1-C1203(R)-1/ SRS1-C1205(R)-1	SRS1-C1D102-1/ SRS1-C1X201-1
Rated input voltage range	4-24VDC \equiv	4-30VDC \equiv	4-30VDC \equiv	4-24VDC \equiv
Allowable input voltage range	4-26.4VDC \equiv	4-32VDC \equiv	4-32VDC \equiv	4-26.4VDC \equiv
Max. input current	15mA (Random turn-on)	13mA (Random turn-on)	13mA (Random turn-on)	15mA
Pick-up voltage	Min. 4VDC \equiv			
Drop-out voltage	Max. 1VDC \equiv			

Output (AC)

Model	SRS1-A1202(R)	SRS1-A1203(R)	SRS1-A1205(R)	SRS1-B1202(R)-2/ SRS1-C1202(R)-2	SRS1-B1203(R)-1/ SRS1-C1203(R)-1	SRS1-B1205(R)-1/ SRS1-C1205(R)-1
Rated load voltage range	24-240VACrms \sim (50/60Hz)			90-240VACrms \sim (50/60Hz)		
Allowable load voltage range	24-264VACrms \sim (50/60Hz)			90-264VACrms \sim (50/60Hz)		
Rated load current	2Arms	3Arms	5Arms	2Arms	3Arms	5Arms
Resistive load (AC-51) \times 1						
Min. load current	0.15Arms	0.2Arms		0.15Arms		
Max. 1cycle surge current (60Hz)	126A	250A		126A		250A
Max. non-repetitive surge current (I ² t, t=8.3ms)	65A ² s	400A ² s		65A ² s		220A ² s
Peak voltage (non-repetitive)	600V					
Leakage current (Ta=25°C)	Max. 2mArms (240VAC \sim /60Hz)					
Output on voltage drop[Vpk] (max. load current)	Max. 1.6V					
Static off-state dv/dt	500V/ μ s					
Turn-on time	Zero cross turn-on	Max. 0.5 cycle of load source + 1ms				
	Random turn-on	Max. 1ms				
Turn-off time	Max. 0.5 cycle of load source + 1ms					

\times 1: AC-51 is utilization category at IEC 60947-4-3.

SRS1 Series

■ Specifications

○ Output (DC, AC/DC)

Model	SRS1-A1D101	SRS1-A1D102	SRS1-A1D201	SRS1-C1D102-1	SRS1-A1X201	SRS1-C1X201-1
Rated load voltage range	5-100VDC≒		5-200VDC≒	5-100VDC≒	5-240VACrms~ (50/60Hz) / 5-200VDC≒	
Allowable load voltage range	3-120VDC≒		3-220VDC≒	3-120VDC≒	3-264VACrms~ (50/60Hz) / 3-220VDC≒	
Rated load current	Resistive load (AC-51) ^{※1}					
	1A _{dc}	2A _{dc}	1A _{dc}	2A _{dc}	1A _{rms} /1A _{dc}	
Min. load current	10mA					10mA
Max. surge current (t=10ms)	5A	10A	4A	10A	4A	
Leakage current	Max. 100μA				Max. 2mA _{rms}	Max. 2mA _{rms} (240VAC~/60Hz)
Output on voltage drop[V _{pk}] (max. load current)	Max. 1.1V				Max. 2.2V	
Static off-state dv/dt	500V/μs			—	500V/μs	—
Turn-on time	Max. 1ms	Max. 2ms	Max. 1ms	Max. 1ms	Max. 2ms	Max. 1ms
Turn-off time	Max. 1ms					

※1: AC-51 is utilization category at IEC60947-4-3.

○ General specifications

Series	SRS1-A	SRS1-B	SRS1-C
Dielectric strength (Vrms)	2,500VAC 50/60Hz 1 min (input-output, input/output-case)		
Insulation resistance	Over 100MΩ (at 500VDC megger)		
Indicator	Input indicator: red LED		
Environment	Ambient temperature	-20 to 70°C, storage: -30 to 100°C	-20 to 80°C, storage: -30 to 100°C
	Ambient humidity	(The rated load current capacity is different depending on ambient temperature. Refer to '■ SSR Derating Curve'.) 45 to 85%RH, storage: 45 to 85%RH	
Protection	IP10 (Protection structure of socket, SK-G05)	According to protection of the universal LY2 socket	According to protection of the universal MY4 socket
Approval	CE c  us		—
Weight ^{※1}	Max. 3A: approx. 270g (approx. 17g) 5A: approx. 380g (approx. 28g)	Approx. 400g (approx. 30g)	Approx. 400g (approx. 30g)

※1: The weight is per 10 units with packing and the weight of parenthesis is per 1 unit.

※Environment resistance is rated at no freezing or condensation.

■ Dimensions

(unit: mm)

○ SRS1-A

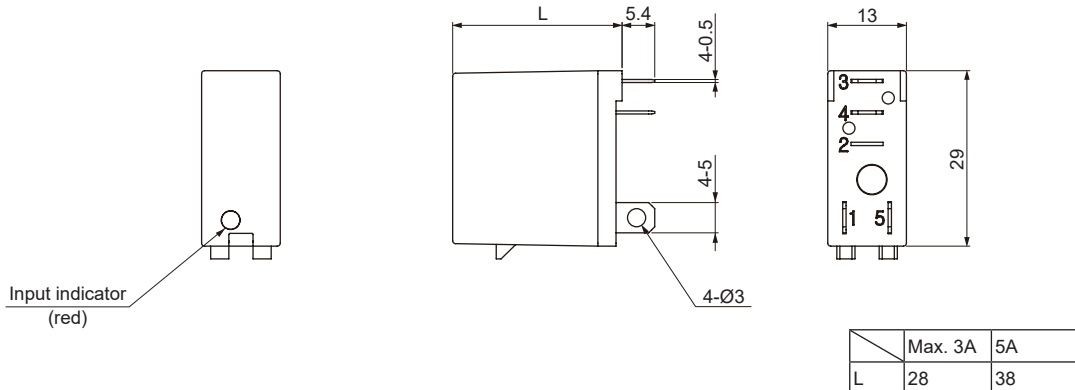

Single-Phase, Socket Type SSR

● Dedicated socket for SRS1-A: SK-G05 (sold separately)

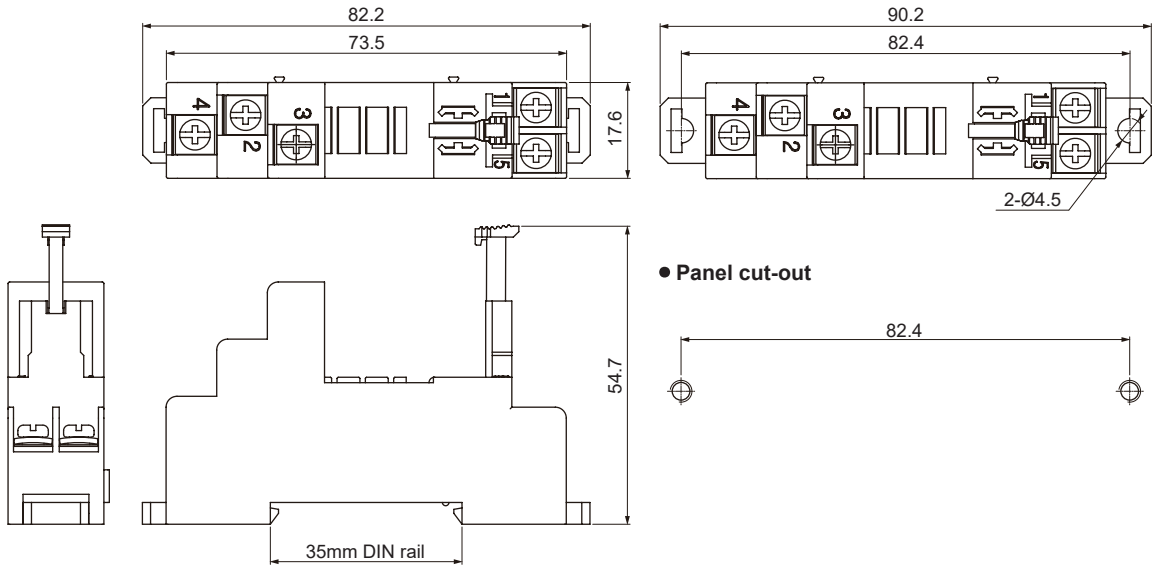

◎ SRS1-B

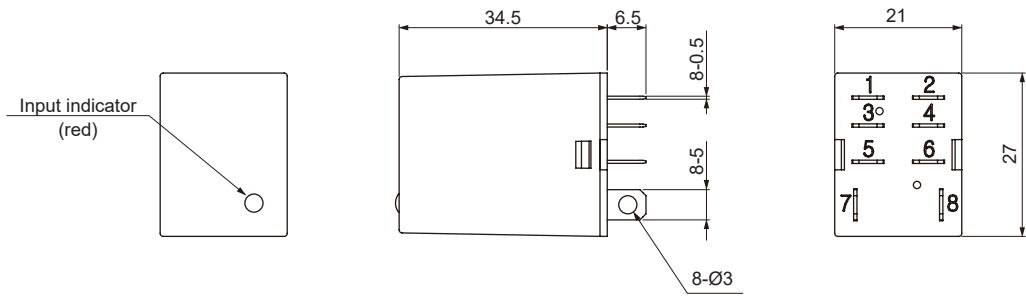

◎ SRS1-C

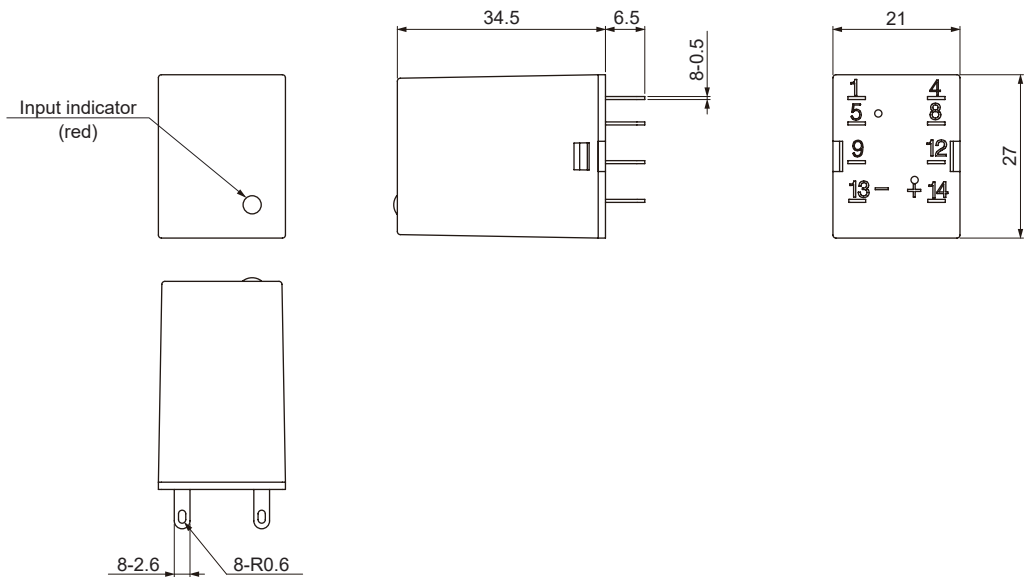

SENSORS
CONTROLLERS
MOTION DEVICES
SOFTWARE

(J) Temperature Controllers
(K) SSRs
(L) Power Controllers
(M) Counters
(N) Timers
(O) Digital Panel Meters
(P) Indicators
(Q) Converters
(R) Digital Display Units
(S) Sensor Controllers
(T) Switching Mode Power Supplies
(U) Recorders
(V) HMIs
(W) Panel PC
(X) Field Network Devices

SRS1 Series

■ Connections

◎ SRS1-A

● SRS1-A1202(R)/SRS1-A1203(R)/SRS1-A1205(R)

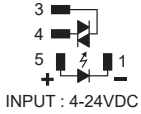

※SRS1-A1202(R)
: 240VAC 2A RESISTIVE LOAD
SRS1-A1203(R)
: 240VAC 3A RESISTIVE LOAD
SRS1-A1205(R)
: 240VAC 5A RESISTIVE LOAD

● SRS1-A1D101/SRS1-A1D102/SRS1-A1D201

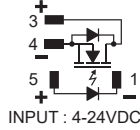

※SRS1-A1D101
: 100VDC 1A RESISTIVE LOAD
SRS1-A1D102
: 100VDC 2A RESISTIVE LOAD
SRS1-A1D201
: 200VDC 1A RESISTIVE LOAD

● SRS1-A1X201

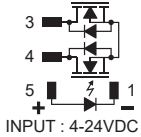

※SRS1-A1X201
: 200VDC 1A RESISTIVE LOAD
: 240VAC 1A RESISTIVE LOAD

◎ SRS1-B

● SRS1-B1202(R)-2

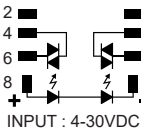

※SRS1-B1202(R)-2
: 240VAC 2A RESISTIVE LOAD

● SRS1-B1203(R)-1/SRS1-B1205(R)-1

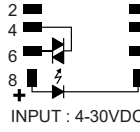

※SRS1-B1203(R)-1
: 240VAC 3A RESISTIVE LOAD
SRS1-B1205(R)-1
: 240VAC 5A RESISTIVE LOAD

◎ SRS1-C

● SRS1-C1202(R)-2

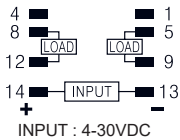

※SRS1-C1202(R)-2
: 240VAC 2A RESISTIVE LOAD

● SRS1-C1203(R)-1/SRS1-C1205(R)-1

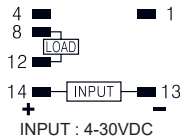

※SRS1-C1203(R)-1
: 240VAC 3A RESISTIVE LOAD
SRS1-C1205(R)-1
: 240VAC 5A RESISTIVE LOAD

● SRS1-C1D102-1/SRS1-C1X201-1

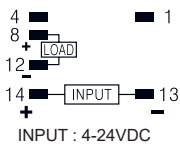

※SRS1-C1D102-1
: 100VDC 2A RESISTIVE LOAD
SRS1-C1X201-1
: 200VDC 1A RESISTIVE LOAD
: 240VAC 1A RESISTIVE LOAD

Single-Phase, Socket Type SSR

Example of Connection

◎ SRS1-A

● AC Load (SRS1-A1202(R)/SRS1-A1203(R)/SRS1-A1205(R))

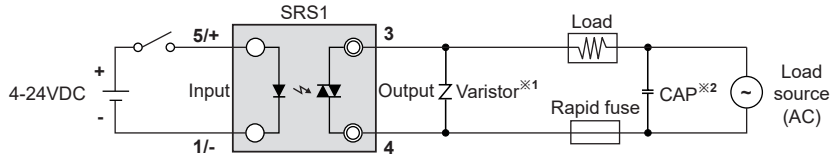

※1: Must use a Varistor (470V, 0.6W)
 ※2: When connecting capacitor as above, it is appropriate for EMC. CAP: 1 μ F/250VAC

● DC Load (SRS1-A1D101/SRS1-A1D102/SRS1-A1D201)

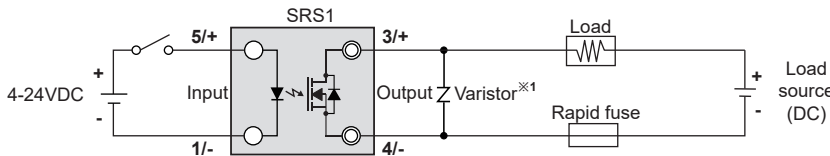

※1: Must use a Varistor (SRS1-A1D101/SRS1-A1D102: 270V, 0.6W) (SRS1-A1D201: 470V, 0.6W)

● AC/DC Load (SRS1-A1X201)

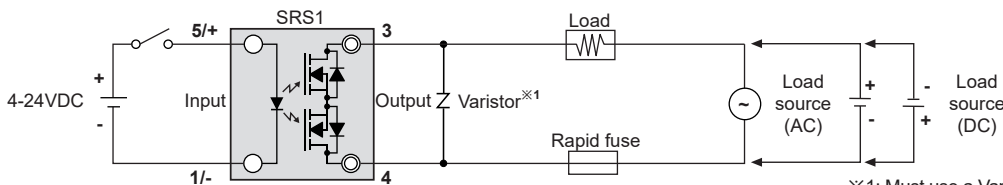

※1: Must use a Varistor (470V, 0.6W)

◎ SRS1-B

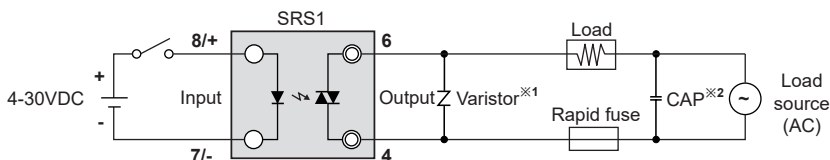

※1: Must use a Varistor (470V, 0.6W)
 ※2: When connecting capacitor as above, it is appropriate for EMC. CAP: 1 μ F/250VAC

◎ SRS1-C

● AC Load (SRS1-C1202(R)-2/SRS1-C1203(R)-1/SRS1-C1205(R)-1)

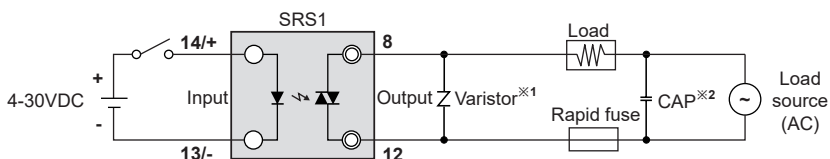

※1: Must use a Varistor (470V, 0.6W)
 ※2: When connecting capacitor as above, it is appropriate for EMC. CAP: 1 μ F/250VAC

● DC Load (SRS1-C1D102-1)

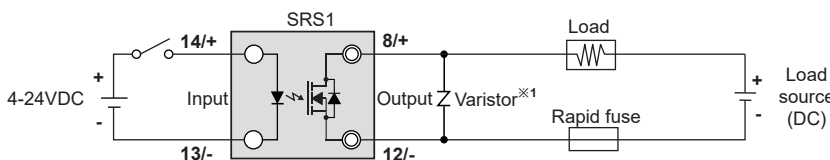

※1: Must use a Varistor (270V, 0.6W)

● AC/DC Load (SRS1-C1X201-1)

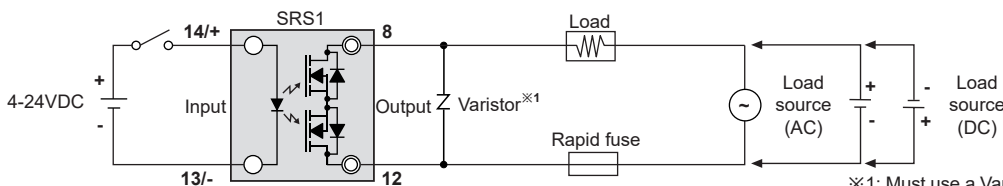

※1: Must use a Varistor (470V, 0.6W)

SENSORS
CONTROLLERS
MOTION DEVICES
SOFTWARE
(J) Temperature Controllers
(K) SSRs
(L) Power Controllers
(M) Counters
(N) Timers
(O) Digital Panel Meters
(P) Indicators
(Q) Converters
(R) Digital Display Units
(S) Sensor Controllers
(T) Switching Mode Power Supplies
(U) Recorders
(V) HMIs
(W) Panel PC
(X) Field Network Devices

SRS1 Series

■ SSR Derating Curve

◎ SRS1-A

- SRS1-A1202(R)/SRS1-A1203(R)/SRS1-A1205(R)

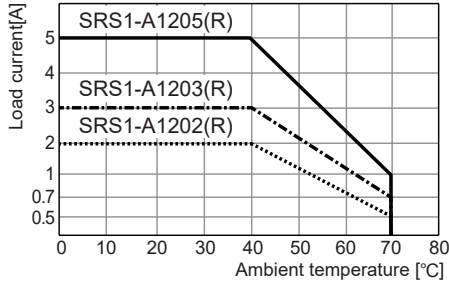

- SRS1-A1D102/SRS1-A1D101/SRS1-A1D201/SRS1-A1X201

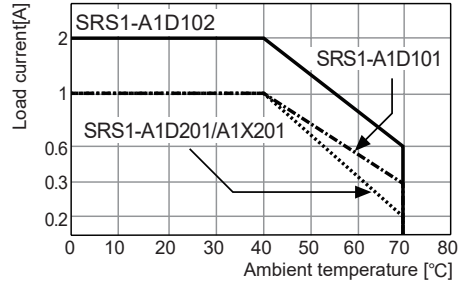

◎ SRS1-B

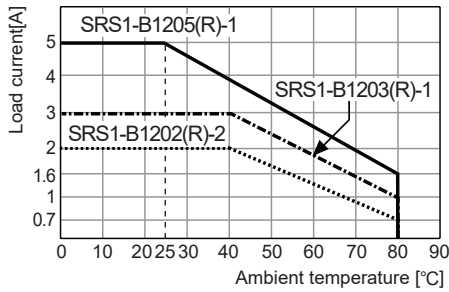

◎ SRS1-C

- SRS1-C1202(R)-2/SRS1-C1203(R)-1/SRS1-C1205(R)-1

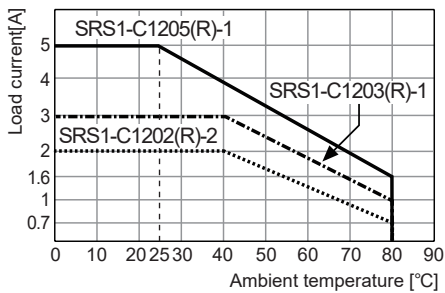

- SRS1-C1D102-1/SRS1-C1X201-1

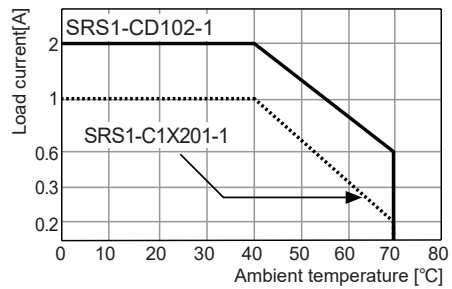

⚠ Since effectiveness of the heat radiation is decreased when multiple SSRs are installed closely, please supply less than 50% of the rated load current.

✖ Above SSR derating curves obtained approval from the UL certification authority.

Single-Phase, Socket Type SSR

■ Proper Usage

⚠ Cautions during use

1. Follow instructions in 'Cautions during Use'. Otherwise, it may cause unexpected accidents.
2. 4-24VDC, 4-30VDC signal input should be insulated and limited voltage/current or Class 2, SELV power supply device.
3. Install the unit in the well ventilated place.
4. While supplying power to the load or right after turning off the power of the load, do not touch the body.
Failure to follow this instruction may result in a burn due to the high temperature.
5. In order to protect the product from the short-circuit current of the load, use rapid fuse of which I^2t is under the 1/2 of SSR I^2t . When short-circuited, replace the fuse to those of same specification with the used rapid fuse.
6. Install dummy resistance in parallel with the load, to keep the sum of current flowing in the load and dummy resistance being over SSR minimum load current.
7. When using random turn-on model for phase control, install noise filter between the load and the power of the load.
8. Do not use near the equipment which generates strong magnetic force or high frequency noise.
9. This unit may be used in the following environments.
 - ① Indoors (in the environment condition rated in 'Specifications')
 - ② Altitude max. 2,000m
 - ③ Pollution degree 2
 - ④ Installation category II

SENSORS
CONTROLLERS
MOTION DEVICES
SOFTWARE

(J) Temperature Controllers
(K) SSRs
(L) Power Controllers
(M) Counters
(N) Timers
(O) Digital Panel Meters
(P) Indicators
(Q) Converters
(R) Digital Display Units
(S) Sensor Controllers
(T) Switching Mode Power Supplies
(U) Recorders
(V) HMIs
(W) Panel PC
(X) Field Network Devices