





High Isolation Gate Drive Transformers



-  Rugged design for Industrial Applications
-  UL recognized, TUV approved to IEC 60950
-  Up to 4250Vrms gate to drive isolation
-  IEC 61558, IEC 61010 & IEC 60601 reinforced insulation compliant designs

Electrical Specifications @ 25°C - Operating Temperature -40°C to +125°C

Part ^{3,4} Number	Turns Ratio	ET (V * μsec MAX)	Primary Inductance (1-10) (μH MIN)	Leakage Inductance Gate to Drive (μH MAX)	DCR Drive (1-10) (mΩ ±20%)	DCR Gates (mΩ ±20%)	Hi-Pot	
							Drive-Gate (Vrms)	Gate-Gate (Vrms)
P0584NL	1:1:1	92	450	0.5	80	72	3000	1500
P0585NL	1:1:1:1	92	450	1.3	330	180	3000	1500*
P0584ANL	1:1:1	114	686	0.8	710	710	4250	1500
P0585ANL	1:1:1:1	114	686	2.2	710	710	4250	1500*

Notes:

1. The max ET is calculated to limit the core loss and temperature rise at 100KHz based on a bipolar flux swing of 180mT Peak. The applied ET may need to be derated for higher frequencies based on the temperature rise which results from the core and copper losses.
2. The temperature rise of the component is calculated based on the total core loss and copper loss:
 - A. To calculate total copper loss (W), use the following formula:
Copper Loss (W) = $I_{rms}^2 * (DCR_Drive + (\# \text{ of Gates}) * DCR_Gates)$
 - B. To calculate total core loss (W), use the following formula:
Core Loss (W) = $6.5E-10 * (\text{Frequency in kHz})^{1.67} * (180 * [ET/ET Max])^{2.53}$
Where ET is the applied Volt Second, ET Max is the rated Volt Second for 180mT flux swing
 - C. To calculate temperature rise, use the following formula:
Temperature Rise (C) = $63 * (\text{Core Loss(W)} + \text{Copper Loss (W)})$
3. 500Vrms Hi-Pot between pins 5 & 6.
4. NL versions, which use triple insulated Teflon wire on the drive winding and magnetic wire on the gate windings, are TUV certified. 600Vrms isolation rating is provided between drive and gate windings.
ANL versions, which use triple insulated wire on both the drive and gate windings, are compliant with IEC 61558, IEC 61010 & IEC 60601. 1000Vrms isolation rating is provided between all winding except those terminate to pins 5 & 6.

Mechanicals

Schematics

P058xxNL

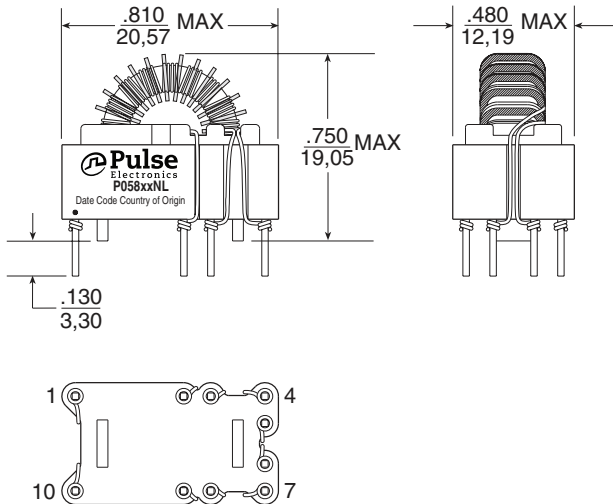

P0584NL/P0584ANL

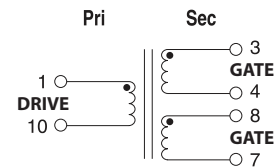

P0585NL/P0585ANL

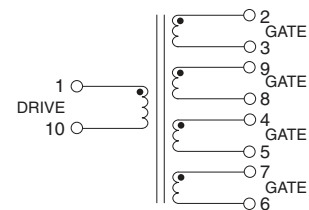

P0584NL/P0584ANL (6 pins)

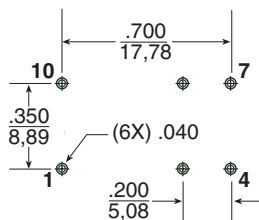

P0585NL/P0585ANL (10 pins)

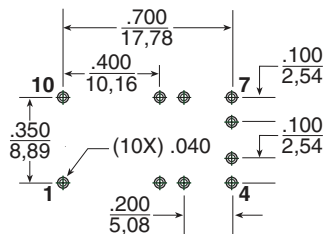

SUGGESTED PCB HOLE PATTERN

Weight5 grams
 Tray80/tray

Dimension: $\frac{\text{Inches}}{\text{mm}}$
 Unless otherwise specified, all tolerances are $\pm \frac{.010}{0,25}$

For More Information

Pulse Worldwide Headquarters

15255 Innovation Drive Ste 100
 San Diego, CA 92128
 U.S.A.

Pulse Europe

Pulse Electronics GmbH
 Am Rottland 12
 58540 Meinerzhagen
 Germany

Pulse China Headquarters

Pulse Electronics (Shenzhen) CO., LTD
 D708, Shenzhen Academy of
 Aerospace Technology,
 The 10th Keji South Road,
 Nanshan District, Shenzhen,
 P.R. China 518057

Pulse North China

Room 2704/2705
 Super Ocean Finance Ctr.
 2067 Yan An Road West
 Shanghai 200336
 China

Pulse South Asia

3 Fraser Street
 0428 DUO Tower
 Singapore 189352

Pulse North Asia

1F., No.111 Xiyuan Rd
 Zhongli City
 Taoyuan City 32057
 Taiwan (R.O.C)

Tel: 858 674 8100
 Fax: 858 674 8262

Tel: 49 2354 777 100
 Fax: 49 2354 777 168

Tel: 86 755 33966678
 Fax: 86 755 33966700

Tel: 86 21 62787060
 Fax: 86 2162786973

Tel: 65 6287 8998
 Fax: 65 6280 0080

Tel: 886 3 4356768
 Fax: 886 3 4356820

Performance warranty of products offered on this data sheet is limited to the parameters specified. Data is subject to change without notice. Other brand and product names mentioned herein may be trademarks or registered trademarks of their respective owners. © Copyright, 2018, Pulse Electronics, Inc. All rights reserved.