

**5.5 V INPUT, 100 mA CMOS VOLTAGE REGULATOR
WITH 0.35 μ A SUPER LOW CURRENT CONSUMPTION**

The S-1317 Series, developed by using the CMOS technology, is a positive voltage regulator IC, which features super low current consumption and low dropout voltage. This IC has low current consumption of 0.35 μ A typ. and high-accuracy output voltage of $\pm 1.0\%$. It is most suitable for use in portable equipment and battery-powered devices.

■ Features

- Output voltage: 1.0 V to 3.5 V, selectable in 0.05 V step
- Input voltage: 1.5 V to 5.5 V
- Output voltage accuracy: $\pm 1.0\%$ (1.0 V to 1.45 V output product: ± 15 mV) ($T_a = +25^\circ\text{C}$)
- Dropout voltage: 20 mV typ. (2.5 V output product, at $I_{\text{OUT}} = 10$ mA) ($T_a = +25^\circ\text{C}$)
- Current consumption during operation: 0.35 μ A typ. ($T_a = +25^\circ\text{C}$)
- Output current: Possible to output 100 mA (at $V_{\text{IN}} \geq V_{\text{OUT(S)}} + 1.0$ V)*1
- Input capacitor: A ceramic capacitor can be used. (1.0 μ F or more)
- Output capacitor: A ceramic capacitor can be used. (1.0 μ F to 100 μ F)
- Built-in overcurrent protection circuit: Limits overcurrent of output transistor.
- Operation temperature range: $T_a = -40^\circ\text{C}$ to $+85^\circ\text{C}$
- Lead-free (Sn 100%), halogen-free

*1. Please make sure that the loss of the IC will not exceed the power dissipation when the output current is large.

■ Applications

- Constant-voltage power supply for battery-powered device
- Constant-voltage power supply for portable communication device, digital camera, and digital audio player
- Constant-voltage power supply for home electric appliance

■ Packages

- SOT-23-5
- HSNT-4(1010)

■ Block Diagram

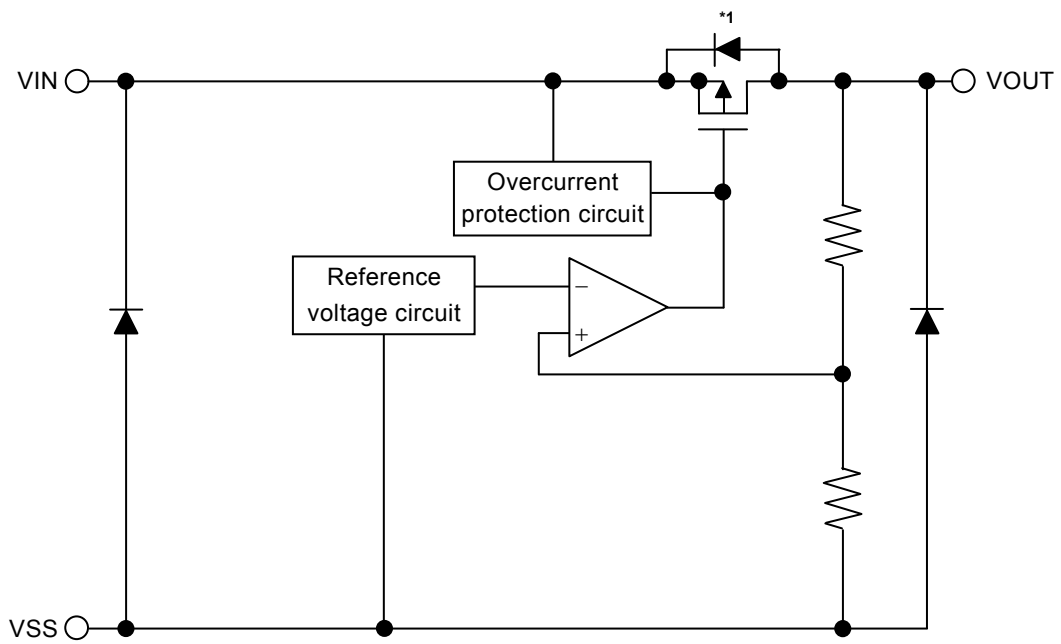

*1. Parasitic diode

Figure 1

■ Product Name Structure

Users can select output voltage and package type for the S-1317 Series. Refer to "1. Product name" regarding the contents of product name, "2. Packages" regarding the package drawings and "3. Product name list" regarding details of the product name.

1. Product name

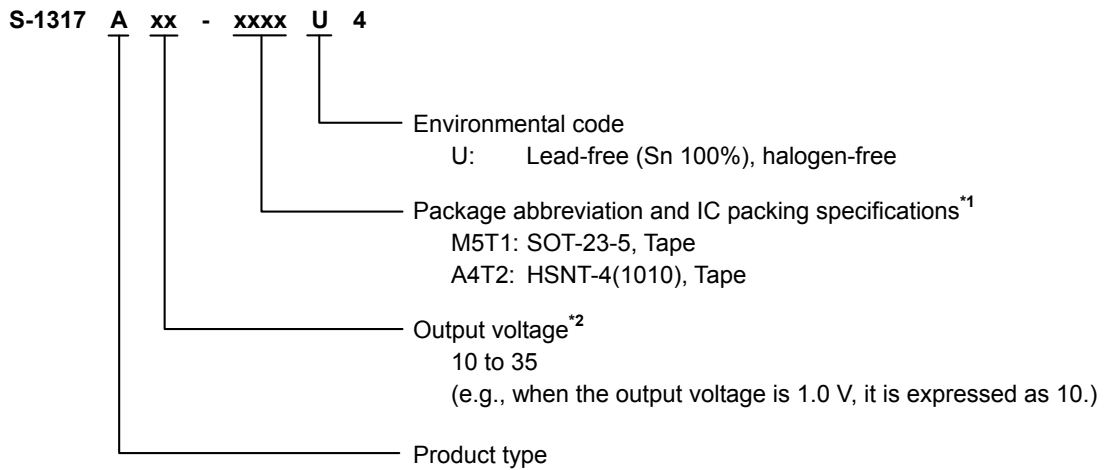

*1. Refer to the tape drawing.

*2. Contact our sales office when the product which has 0.05 V step is necessary.

2. Packages

Table 1 Package Drawing Codes

Package Name	Dimension	Tape	Reel	Land
SOT-23-5	MP005-A-P-SD	MP005-A-C-SD	MP005-A-R-SD	-
HSNT-4(1010)	PL004-A-P-SD	PL004-A-C-SD	PL004-A-R-SD	PL004-A-L-SD

3. Product name list

Table 2

Output Voltage	SOT-23-5	HSNT-4(1010)
1.0 V \pm 15 mV	S-1317A10-M5T1U4	S-1317A10-A4T2U4
1.2 V \pm 15 mV	S-1317A12-M5T1U4	S-1317A12-A4T2U4
1.8 V \pm 1.0%	S-1317A18-M5T1U4	S-1317A18-A4T2U4
2.5 V \pm 1.0%	S-1317A25-M5T1U4	S-1317A25-A4T2U4
3.0 V \pm 1.0%	S-1317A30-M5T1U4	S-1317A30-A4T2U4

Remark Please contact our sales office for products with specifications other than the above.

■ Pin Configurations

1. SOT-23-5

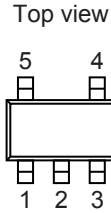

Figure 2

Table 3

Pin No.	Symbol	Description
1	VIN	Input voltage pin
2	VSS	GND pin
3	NC ^{*1}	No connection
4	NC ^{*1}	No connection
5	VOUT	Output voltage pin

- *1. The NC pin is electrically open.
 The NC pin can be connected to the VIN pin or the VSS pin.

2. HSNT-4(1010)

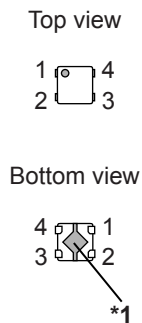

Figure 3

Table 4

Pin No.	Symbol	Description
1	VOUT	Output voltage pin
2	VSS	GND pin
3	NC ^{*2}	No connection
4	VIN	Input voltage pin

- *1. Connect the heat sink of backside at shadowed area to the board, and set electric potential open or GND.
 However, do not use it as the function of electrode.
- *2. The NC pin is electrically open.
 The NC pin can be connected to the VIN pin or the VSS pin.

■ **Absolute Maximum Ratings**

Table 5

(Ta = +25°C unless otherwise specified)

Item	Symbol	Absolute Maximum Rating	Unit
Input voltage	V _{IN}	V _{SS} - 0.3 to V _{SS} + 6.0	V
Output voltage	V _{OUT}	V _{SS} - 0.3 to V _{IN} + 0.3	V
Output current	I _{OUT}	120	mA
Operation ambient temperature	T _{opr}	-40 to +85	°C
Storage temperature	T _{stg}	-40 to +125	°C

Caution The absolute maximum ratings are rated values exceeding which the product could suffer physical damage. These values must therefore not be exceeded under any conditions.

■ **Thermal Resistance Value**

Table 6

Item	Symbol	Condition	Min.	Typ.	Max.	Unit	
Junction-to-ambient thermal resistance *1	θ_{JA}	SOT-23-5	Board A	-	192	-	°C/W
			Board B	-	160	-	°C/W
			Board C	-	-	-	°C/W
			Board D	-	-	-	°C/W
			Board E	-	-	-	°C/W
		HSNT-4(1010)	Board A	-	378	-	°C/W
			Board B	-	317	-	°C/W
			Board C	-	-	-	°C/W
			Board D	-	-	-	°C/W
			Board E	-	-	-	°C/W

*1. Test environment: compliance with JEDEC STANDARD JESD51-2A

Remark Refer to "■ Power Dissipation" and "Test Board" for details.

■ Electrical Characteristics

Table 7

(Ta = +25°C unless otherwise specified)

Item	Symbol	Condition	Min.	Typ.	Max.	Unit	Test Circuit	
Output voltage*1	V _{OUT(E)}	V _{IN} = V _{OUT(S)} + 1.0 V, I _{OUT} = 10 mA	1.0 V ≤ V _{OUT(S)} < 1.5 V	V _{OUT(S)} − 0.015	V _{OUT(S)}	V _{OUT(S)} + 0.015	V	1
			1.5 V ≤ V _{OUT(S)} ≤ 3.5 V	V _{OUT(S)} × 0.99	V _{OUT(S)}	V _{OUT(S)} × 1.01	V	1
Output current*2	I _{OUT}	V _{IN} ≥ V _{OUT(S)} + 1.0 V	100*5	–	–	mA	3	
Dropout voltage*3	V _{drop}	I _{OUT} = 10 mA	1.0 V ≤ V _{OUT(S)} < 1.1 V	0.50	–	–	V	1
			1.1 V ≤ V _{OUT(S)} < 1.2 V	0.40	–	–	V	1
			1.2 V ≤ V _{OUT(S)} < 1.3 V	0.30	–	–	V	1
			1.3 V ≤ V _{OUT(S)} < 1.4 V	0.20	–	–	V	1
			1.4 V ≤ V _{OUT(S)} < 1.5 V	0.10	–	–	V	1
			1.5 V ≤ V _{OUT(S)} < 1.7 V	–	0.050	0.080	V	1
			1.7 V ≤ V _{OUT(S)} < 1.8 V	–	0.040	0.060	V	1
			1.8 V ≤ V _{OUT(S)} < 2.0 V	–	0.040	0.050	V	1
			2.0 V ≤ V _{OUT(S)} < 2.5 V	–	0.030	0.040	V	1
			2.5 V ≤ V _{OUT(S)} < 2.8 V	–	0.020	0.030	V	1
2.8 V ≤ V _{OUT(S)} < 3.0 V	–	0.019	0.021	V	1			
3.0 V ≤ V _{OUT(S)} ≤ 3.5 V	–	0.018	0.020	V	1			
Line regulation	$\frac{\Delta V_{OUT1}}{\Delta V_{IN} \cdot V_{OUT}}$	V _{OUT(S)} + 0.5 V ≤ V _{IN} ≤ 5.5 V, I _{OUT} = 10 mA	–	0.05	0.2	%/V	1	
Load regulation	ΔV_{OUT2}	V _{IN} = V _{OUT(S)} + 1.0 V, 1 μ A ≤ I _{OUT} ≤ 50 mA	–	20	40	mV	1	
Output voltage temperature coefficient*4	$\frac{\Delta V_{OUT}}{\Delta Ta \cdot V_{OUT}}$	V _{IN} = V _{OUT(S)} + 1.0 V, I _{OUT} = 10 mA, −40°C ≤ Ta ≤ +85°C	–	±130	–	ppm/°C	1	
Current consumption during operation	I _{SS1}	V _{IN} = V _{OUT(S)} + 1.0 V, no load	–	0.35	0.53	μ A	2	
Input voltage	V _{IN}	–	1.5	–	5.5	V	–	
Short-circuit current	I _{short}	V _{IN} = V _{OUT(S)} + 1.0 V, V _{OUT} = 0 V	–	60	–	mA	3	

*1. V_{OUT(S)}: Set output voltage

V_{OUT(E)}: Actual output voltage

Output voltage when fixing I_{OUT} (= 10 mA) and inputting V_{OUT(S)} + 1.0 V

*2. The output current at which the output voltage becomes 95% of V_{OUT(E)} after gradually increasing the output current.

*3. V_{drop} = V_{IN1} − (V_{OUT3} × 0.98)

V_{IN1} is the input voltage at which the output voltage becomes 98% of V_{OUT3} after gradually decreasing the input voltage.

V_{OUT3} is the output voltage when V_{IN} = V_{OUT(S)} + 1.0 V and I_{OUT} = 10 mA.

*4. A change in the temperature of the output voltage [mV/°C] is calculated using the following equation.

$$\frac{\Delta V_{OUT}}{\Delta Ta} \text{ [mV/°C]}^*1 = V_{OUT(S)} \text{ [V]}^*2 \times \frac{\Delta V_{OUT}}{\Delta Ta \cdot V_{OUT}} \text{ [ppm/°C]}^*3 \div 1000$$

*1. Change in temperature of output voltage

*2. Set output voltage

*3. Output voltage temperature coefficient

*5. Due to limitation of the power dissipation, this value may not be satisfied. Attention should be paid to the power dissipation when the output current is large.

This specification is guaranteed by design.

■ Test Circuits

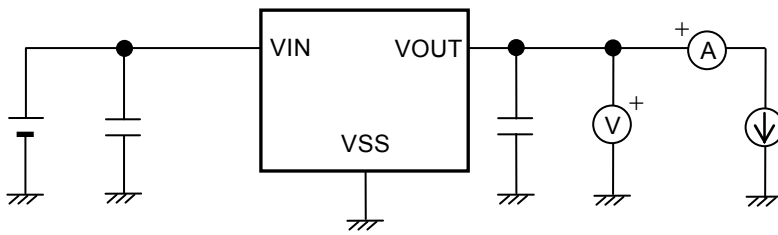

Figure 4 Test Circuit 1

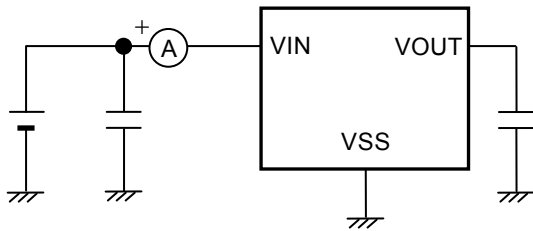

Figure 5 Test Circuit 2

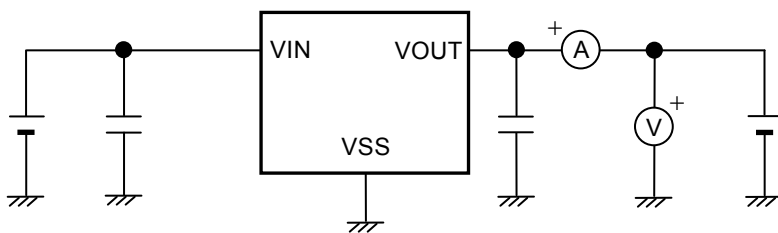
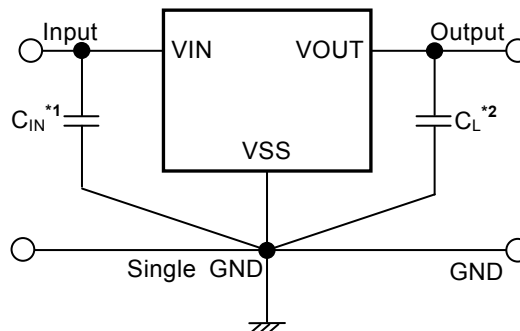

Figure 6 Test Circuit 3

■ Standard Circuit



- *1. C_{IN} is a capacitor for stabilizing the input.
- *2. C_L is a capacitor for stabilizing the output.

Figure 7

Caution The above connection diagram and constants will not guarantee successful operation. Perform thorough evaluation including the temperature characteristics with an actual application to set the constants.

■ Condition of Application

Input capacitor (C_{IN}): A ceramic capacitor with capacitance of 1.0 μ F or more is recommended.

Output capacitor (C_L): A ceramic capacitor with capacitance of 1.0 μ F to 100 μ F is recommended.

Caution Generally, in a voltage regulator, an oscillation may occur depending on the selection of the external parts. Perform thorough evaluation including the temperature characteristics with an actual application using the above capacitors to confirm no oscillation occurs.

■ Selection of Input Capacitor (C_{IN}) and Output Capacitor (C_L)

The S-1317 Series requires C_L between the VOUT pin and the VSS pin for phase compensation. The operation is stabilized by a ceramic capacitor with capacitance of 1.0 μ F to 100 μ F. When using an OS capacitor, a tantalum capacitor or an aluminum electrolytic capacitor, the capacitance must also be 1.0 μ F to 100 μ F. However, an oscillation may occur depending on the equivalent series resistance (ESR).

Moreover, the S-1317 Series requires C_{IN} between the VIN pin and the VSS pin for a stable operation.

Generally, an oscillation may occur when a voltage regulator is used under the condition that the impedance of the power supply is high. Note that the output voltage transient characteristics vary depending on the capacitance of C_{IN} and C_L and the value of ESR.

Caution Perform thorough evaluation including the temperature characteristics with an actual application to select C_{IN} and C_L .

■ Explanation of Terms

1. Output voltage (V_{OUT})

This voltage is output at an accuracy of $\pm 1.0\%$ or $\pm 15 \text{ mV}^{*2}$ when the input voltage, the output current and the temperature are in a certain condition^{*1}.

*1. Differs depending on the product.

*2. When $V_{OUT} < 1.5 \text{ V}$: $\pm 15 \text{ mV}$, when $V_{OUT} \geq 1.5 \text{ V}$: $\pm 1.0\%$

Caution If the certain condition is not satisfied, the output voltage may exceed the accuracy range of $\pm 1.0\%$ or $\pm 15 \text{ mV}$. Refer to "■ Electrical Characteristics" for details.

2. Line regulation $\left(\frac{\Delta V_{OUT1}}{\Delta V_{IN} \bullet V_{OUT}} \right)$

Indicates the dependency of the output voltage against the input voltage. The value shows how much the output voltage changes due to a change in the input voltage after fixing output current constant.

3. Load regulation (ΔV_{OUT2})

Indicates the dependency of the output voltage against the output current. The value shows how much the output voltage changes due to a change in the output current after fixing input voltage constant.

4. Dropout voltage (V_{drop})

Indicates the difference between input voltage (V_{IN1}) and the output voltage when the output voltage becomes 98% of the output voltage value (V_{OUT3}) at $V_{IN} = V_{OUT(S)} + 1.0 \text{ V}$ after the input voltage (V_{IN}) is decreased gradually.

$$V_{drop} = V_{IN1} - (V_{OUT3} \times 0.98)$$

5. Output voltage temperature coefficient $\left(\frac{\Delta V_{OUT}}{\Delta T_a \bullet V_{OUT}}\right)$

The shaded area in **Figure 8** is the range where V_{OUT} varies in the operation temperature range when the output voltage temperature coefficient is ± 130 ppm/ $^{\circ}$ C.

Example of S-1317A10 typ. product

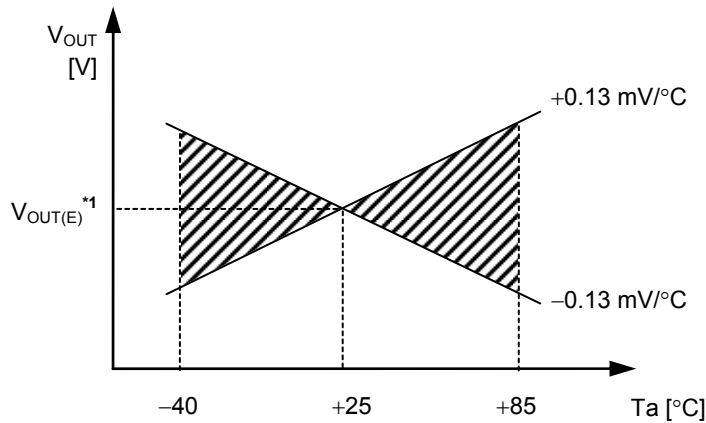

*1. $V_{OUT(E)}$ is the value of the output voltage measured at $T_a = +25^{\circ}$ C.

Figure 8

A change in the temperature of the output voltage [mV/ $^{\circ}$ C] is calculated using the following equation.

$$\frac{\Delta V_{OUT}}{\Delta T_a} \text{ [mV/}^{\circ}\text{C]}^{*1} = V_{OUT(S)} \text{ [V]}^{*2} \times \frac{\Delta V_{OUT}}{\Delta T_a \bullet V_{OUT}} \text{ [ppm/}^{\circ}\text{C]}^{*3} \div 1000$$

- *1. Change in temperature of output voltage
- *2. Set output voltage
- *3. Output voltage temperature coefficient

■ Operation

1. Basic operation

Figure 9 shows the block diagram of the S-1317 Series to describe the basic operation.

The error amplifier compares the feedback voltage (V_{fb}) whose output voltage (V_{OUT}) is divided by the feedback resistors (R_s and R_f) with the reference voltage (V_{ref}). The error amplifier controls the output transistor, consequently, the regulator starts the operation that holds V_{OUT} constant without the influence of the input voltage (V_{IN}).

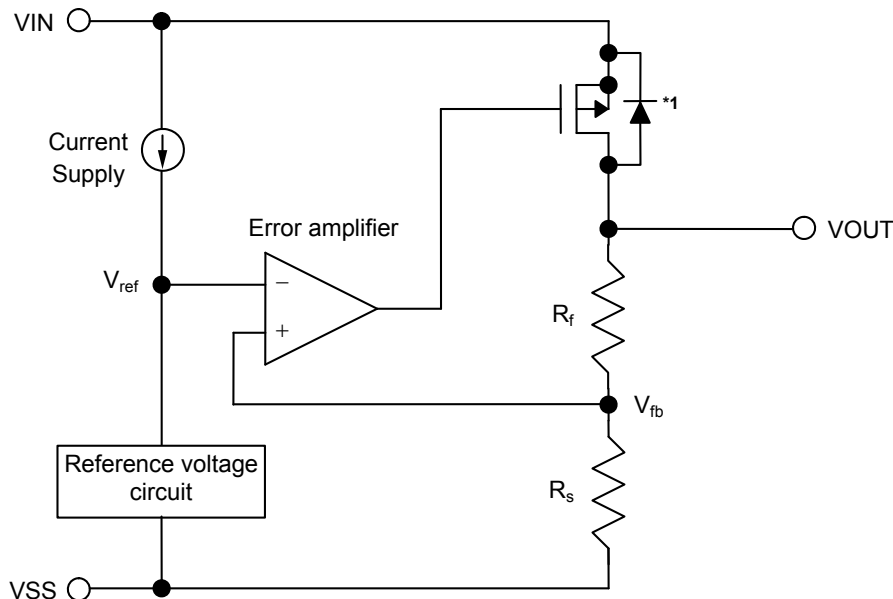

*1. Parasitic diode

Figure 9

2. Output transistor

In the S-1317 Series, a low on-resistance P-channel MOS FET is used between the VIN pin and the VOUT pin as the output transistor. In order to keep V_{OUT} constant, the ON resistance of the output transistor varies appropriately according to the output current (I_{OUT}).

Caution Since a parasitic diode exists between the VIN pin and the VOUT pin due to the structure of the transistor, the IC may be damaged by a reverse current if V_{OUT} becomes higher than V_{IN} . Therefore, be sure that V_{OUT} does not exceed $V_{IN} + 0.3$ V.

3. Overcurrent protection circuit

The S-1317 Series has a built-in overcurrent protection circuit to limit the overcurrent of the output transistor. When the VOUT pin is shorted to the VSS pin, that is, at the time of the output short-circuit, the output current is limited to 60 mA typ. due to the overcurrent protection circuit operation. The S-1317 Series restarts regulating when the output transistor is released from the overcurrent status.

Caution This overcurrent protection circuit does not work as for thermal protection. If this IC long keeps short circuiting inside, pay attention to the conditions of input voltage and load current so that, under the usage conditions including short circuit, the loss of the IC will not exceed power dissipation.

■ Precautions

- Generally, when a voltage regulator is used under the condition that the load current value is small (1 μ A or less), the output voltage may increase due to the leakage current of an output transistor.
- Generally, when a voltage regulator is used under the condition that the temperature is high, the output voltage may increase due to the leakage current of an output transistor.
- Generally, when a voltage regulator is used under the condition that the impedance of the power supply is high, an oscillation may occur. Perform thorough evaluation including the temperature characteristics with an actual application to select C_{IN} .
- Generally, in a voltage regulator, an oscillation may occur depending on the selection of the external parts. The following use conditions are recommended in the S-1317 Series, however, perform thorough evaluation including the temperature characteristics with an actual application to select C_{IN} and C_L .

Input capacitor (C_{IN}): A ceramic capacitor with capacitance of 1.0 μ F or more is recommended.

Output capacitor (C_L): A ceramic capacitor with capacitance of 1.0 μ F to 100 μ F is recommended.

- Generally, in a voltage regulator, the values of an overshoot and an undershoot in the output voltage vary depending on the variation factors of input voltage start-up, input voltage fluctuation and load fluctuation etc., or the capacitance of C_{IN} or C_L and the value of the equivalent series resistance (ESR), which may cause a problem to the stable operation. Perform thorough evaluation including the temperature characteristics with an actual application to select C_{IN} and C_L .
- Generally, in a voltage regulator, if the VOUT pin is steeply shorted with GND, a negative voltage exceeding the absolute maximum ratings may occur in the VOUT pin due to resonance phenomenon of the inductance and the capacitance including C_L on the application. The resonance phenomenon is expected to be weakened by inserting a series resistor into the resonance path, and the negative voltage is expected to be limited by inserting a protection diode between the VOUT pin and the VSS pin.
- Make sure of the conditions for the input voltage, output voltage and the load current so that the internal loss does not exceed the power dissipation.
- Do not apply an electrostatic discharge to this IC that exceeds the performance ratings of the built-in electrostatic protection circuit.
- When considering the output current value that the IC is able to output, make sure of the output current value specified in **Table 7** in "■ Electrical Characteristics" and footnote *5 of the table.
- Wiring patterns on the application related to the VIN pin, the VOUT pin and the VSS pin should be designed so that the impedance is low. When mounting C_{IN} between the VIN pin and the VSS pin and C_L between the VOUT pin and the VSS pin, connect the capacitors as close as possible to the respective destination pins of the IC.
- In the package equipped with heat sink of backside, mount the heat sink firmly. Since the heat radiation differs according to the condition of the application, perform thorough evaluation with an actual application to confirm no problems happen.
- ABLIC Inc. claims no responsibility for any disputes arising out of or in connection with any infringement by products including this IC of patents owned by a third party.

■ **Characteristics (Typical Data)**

1. **Output voltage vs. Output current (When load current increases) (Ta = +25°C)**

1.1 **V_{OUT} = 1.0 V**

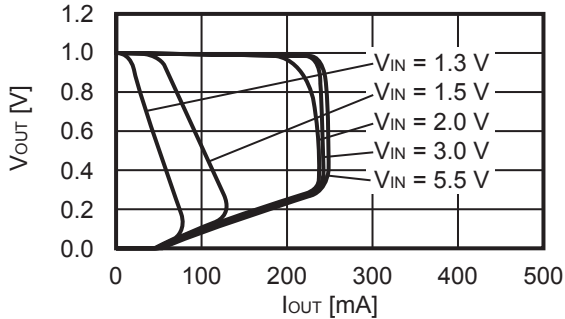

1.2 **V_{OUT} = 2.5 V**

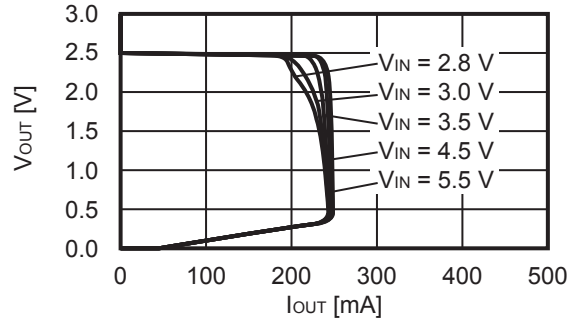

1.3 **V_{OUT} = 3.5 V**

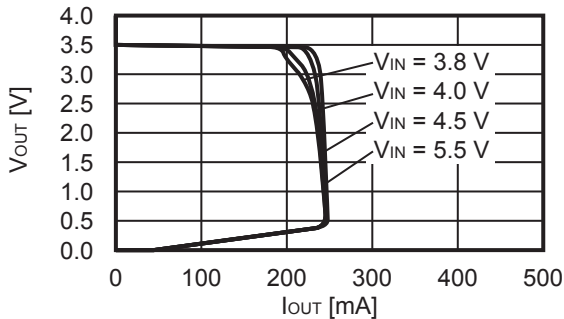

Remark In determining the output current, attention should be paid to the following.

1. The minimum output current value and footnote *5 of Table 7 in "■ **Electrical Characteristics**"
2. Power dissipation

2. **Output voltage vs. Input voltage (Ta = +25°C)**

2.1 **V_{OUT} = 1.0 V**

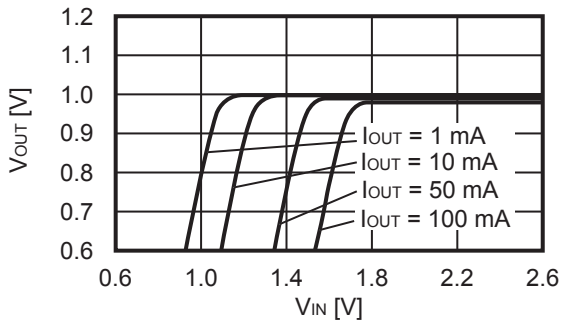

2.2 **V_{OUT} = 2.5 V**

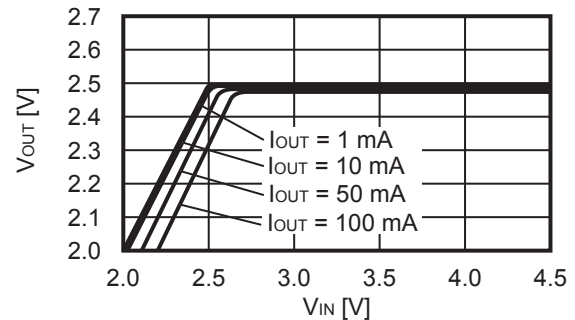

2.3 **V_{OUT} = 3.5 V**

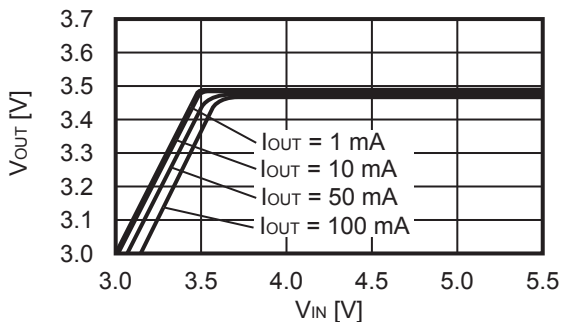

3. Dropout voltage vs. Output current

3.1 $V_{OUT} = 1.0$ V

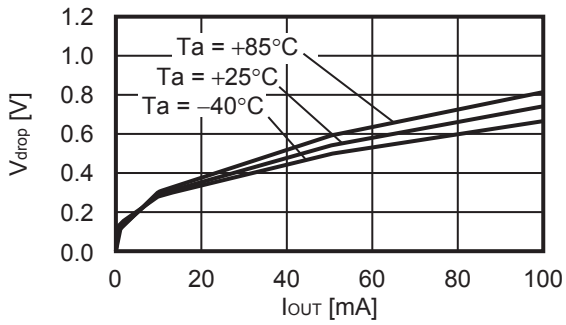

3.2 $V_{OUT} = 2.5$ V

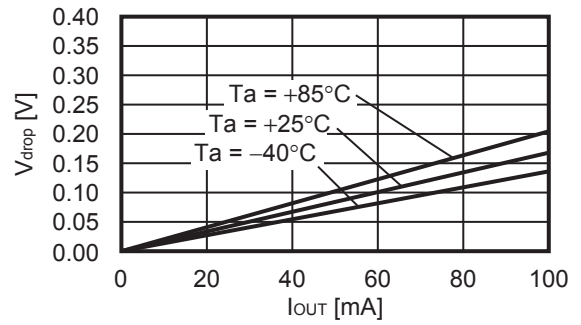

3.3 $V_{OUT} = 3.5$ V

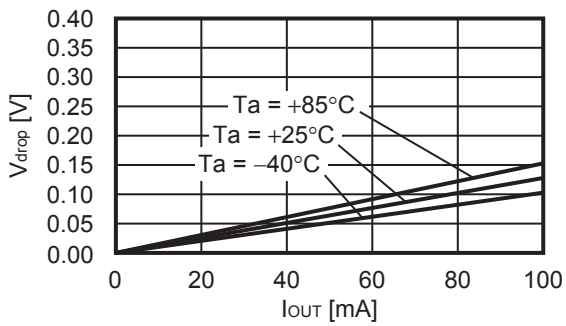

4. Dropout voltage vs. Set output voltage

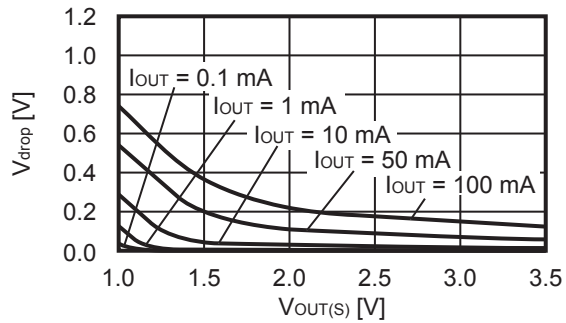

5. Output voltage vs. Ambient temperature

5.1 $V_{OUT} = 1.0$ V

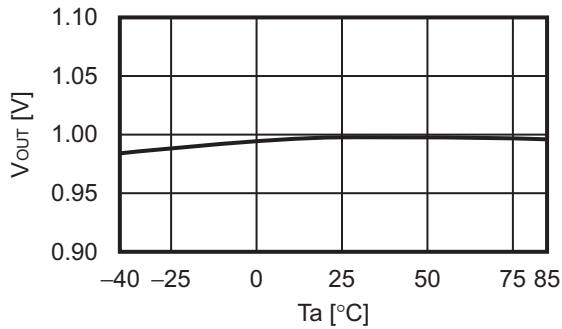

5.2 $V_{OUT} = 2.5$ V

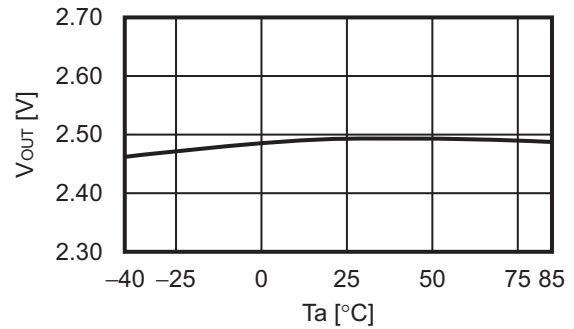

5.3 $V_{OUT} = 3.5$ V

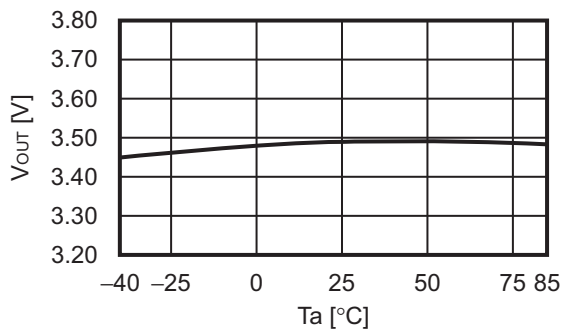

6. Current consumption vs. Input voltage

6.1 $V_{OUT} = 1.0$ V

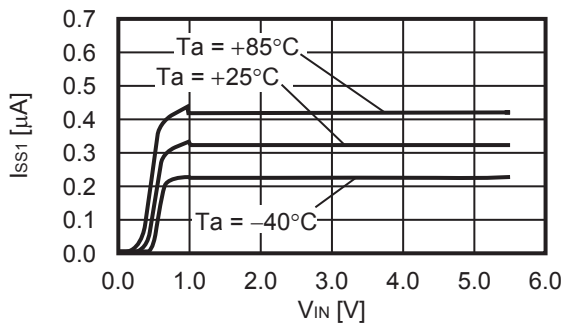

6.2 $V_{OUT} = 2.5$ V

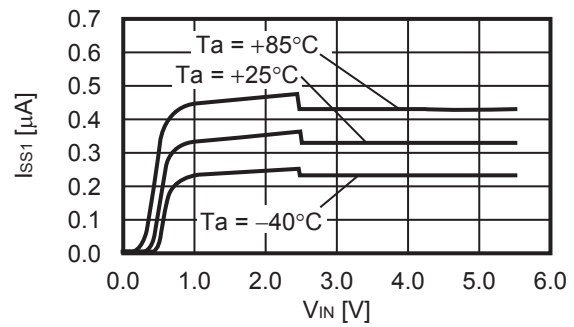

6.3 $V_{OUT} = 3.5$ V

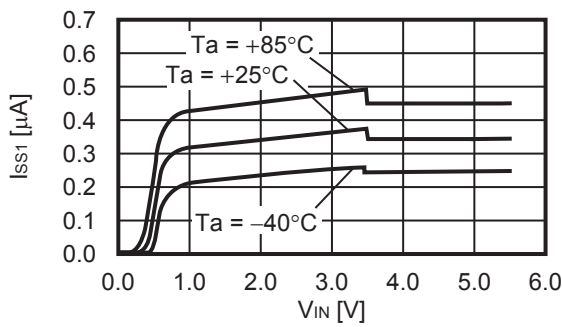

7. Current consumption vs. Ambient temperature

7.1 $V_{OUT} = 1.0$ V

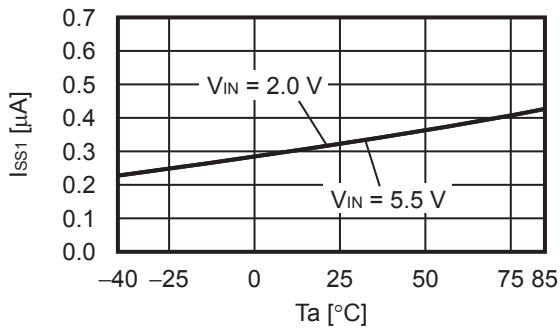

7.2 $V_{OUT} = 2.5$ V

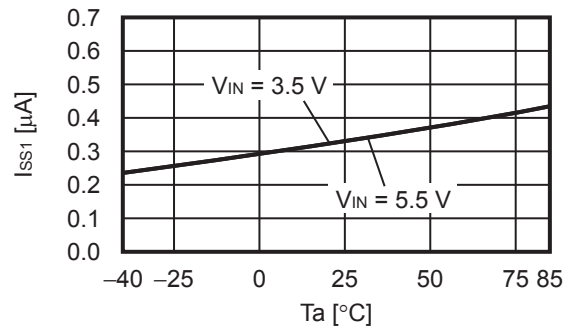

7.3 $V_{OUT} = 3.5$ V

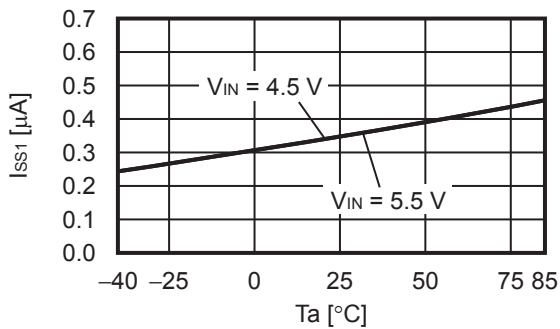

8. Current consumption vs. Output current

8.1 $V_{OUT} = 1.0$ V

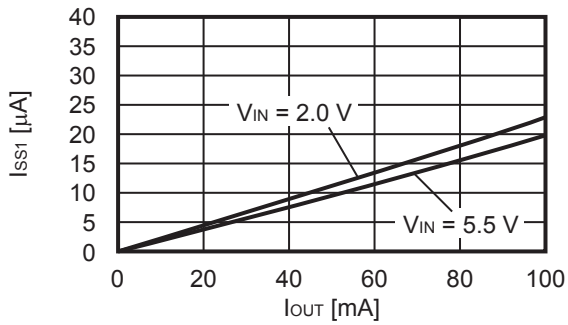

8.2 $V_{OUT} = 2.5$ V

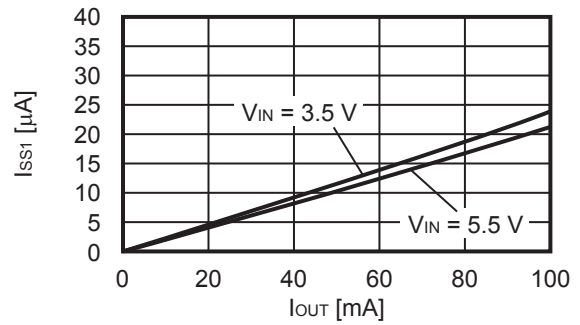

8.3 $V_{OUT} = 3.5$ V

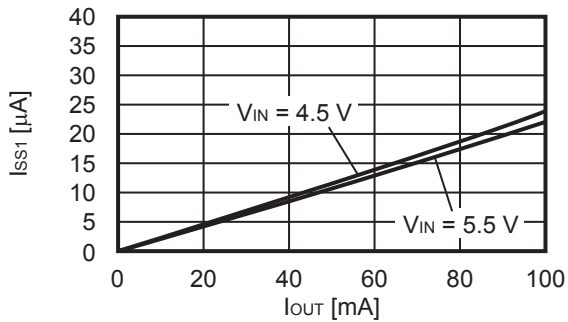

■ **Reference Data**

1. Characteristics of input transient response (Ta = +25°C)

1.1 V_{OUT} = 1.0 V

$I_{OUT} = 1 \text{ mA}$, $C_{IN} = C_L = 1 \mu\text{F}$, $V_{IN} = 2.0 \text{ V} \leftrightarrow 3.0 \text{ V}$, $t_r = t_f = 5.0 \mu\text{s}$

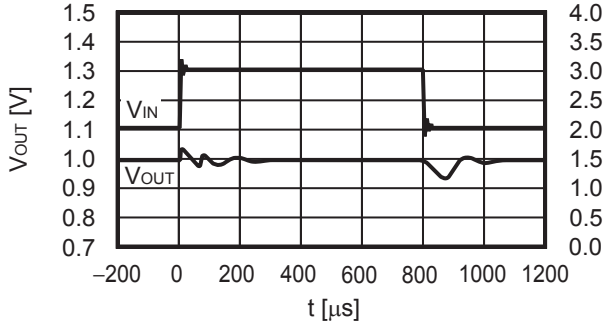

$I_{OUT} = 50 \text{ mA}$, $C_{IN} = C_L = 1 \mu\text{F}$, $V_{IN} = 2.0 \text{ V} \leftrightarrow 3.0 \text{ V}$, $t_r = t_f = 5.0 \mu\text{s}$

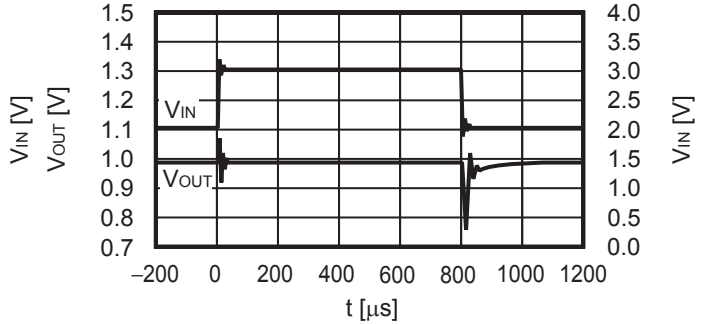

1.2 V_{OUT} = 2.5 V

$I_{OUT} = 1 \text{ mA}$, $C_{IN} = C_L = 1 \mu\text{F}$, $V_{IN} = 3.5 \text{ V} \leftrightarrow 4.5 \text{ V}$, $t_r = t_f = 5.0 \mu\text{s}$

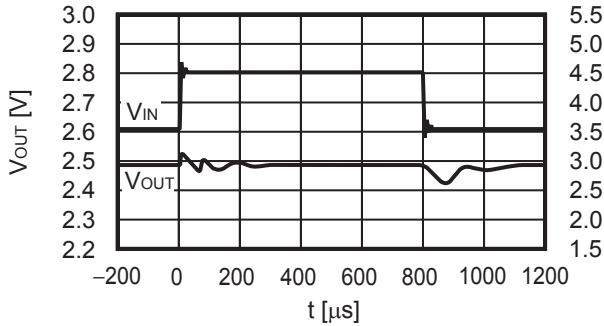

$I_{OUT} = 50 \text{ mA}$, $C_{IN} = C_L = 1 \mu\text{F}$, $V_{IN} = 3.5 \text{ V} \leftrightarrow 4.5 \text{ V}$, $t_r = t_f = 5.0 \mu\text{s}$

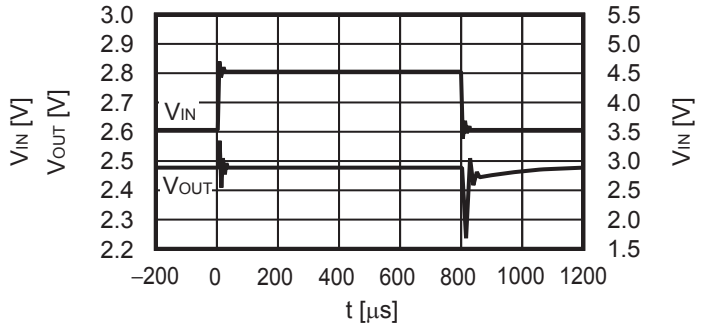

1.3 V_{OUT} = 3.5 V

$I_{OUT} = 1 \text{ mA}$, $C_{IN} = C_L = 1 \mu\text{F}$, $V_{IN} = 4.5 \text{ V} \leftrightarrow 5.5 \text{ V}$, $t_r = t_f = 5.0 \mu\text{s}$

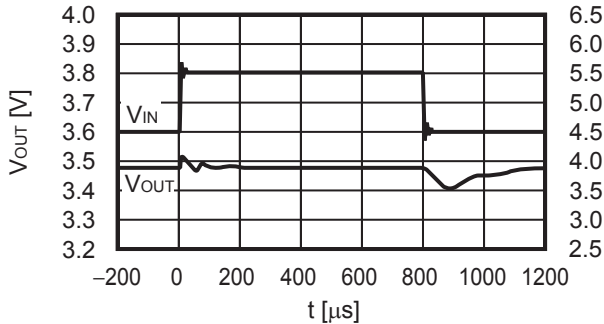

$I_{OUT} = 50 \text{ mA}$, $C_{IN} = C_L = 1 \mu\text{F}$, $V_{IN} = 4.5 \text{ V} \leftrightarrow 5.5 \text{ V}$, $t_r = t_f = 5.0 \mu\text{s}$

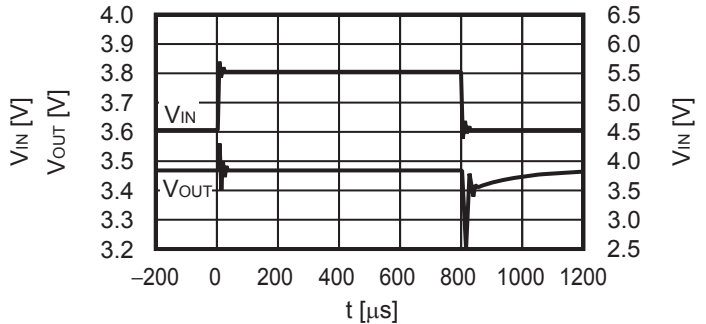

2. Characteristics of load transient response (Ta = +25°C)

2.1 V_{OUT} = 1.0 V

V_{IN} = 2.0 V, C_{IN} = C_L = 1 μ F, I_{OUT} = 1 mA \leftrightarrow 10 mA, t_r = t_f = 5.0 μ s

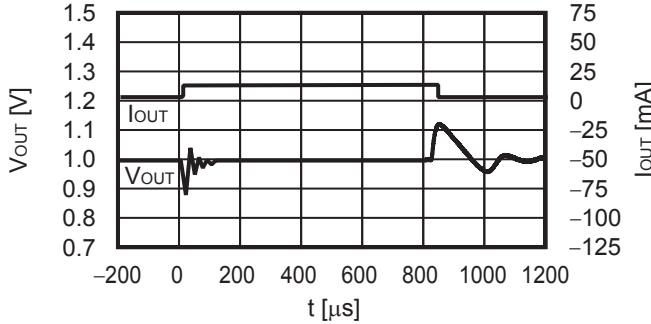

V_{IN} = 2.0 V, C_{IN} = C_L = 1 μ F, I_{OUT} = 10 mA \leftrightarrow 50 mA, t_r = t_f = 5.0 μ s

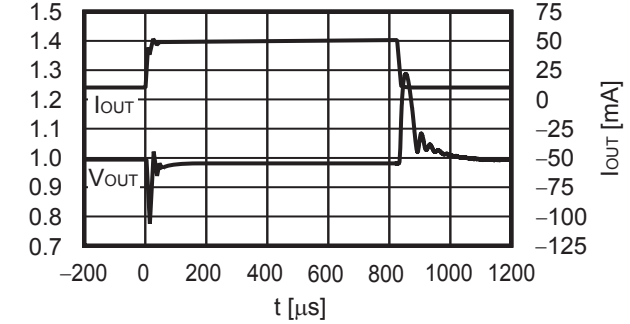

2.2 V_{OUT} = 2.5 V

V_{IN} = 3.5 V, C_{IN} = C_L = 1 μ F, I_{OUT} = 1 mA \leftrightarrow 10 mA, t_r = t_f = 5.0 μ s

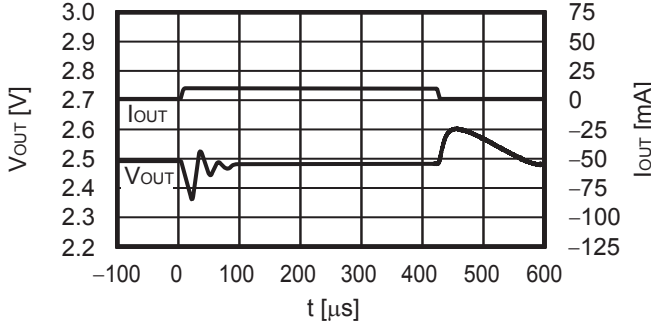

V_{IN} = 3.5 V, C_{IN} = C_L = 1 μ F, I_{OUT} = 10 mA \leftrightarrow 50 mA, t_r = t_f = 5.0 μ s

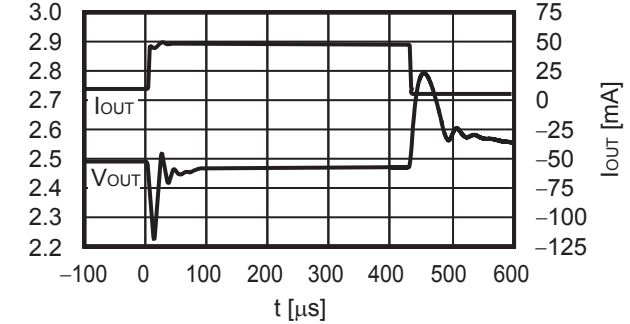

2.3 V_{OUT} = 3.5 V

V_{IN} = 4.5 V, C_{IN} = C_L = 1 μ F, I_{OUT} = 1 mA \leftrightarrow 10 mA, t_r = t_f = 5.0 μ s

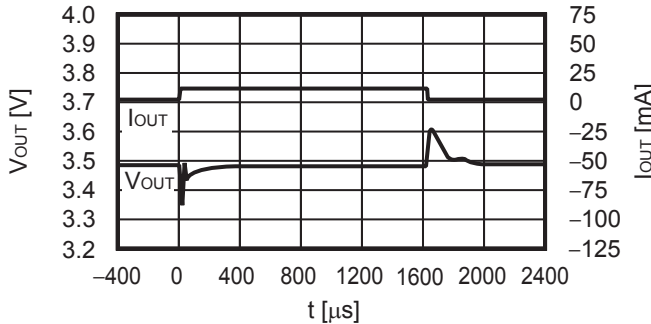

V_{IN} = 4.5 V, C_{IN} = C_L = 1 μ F, I_{OUT} = 10 mA \leftrightarrow 50 mA, t_r = t_f = 5.0 μ s

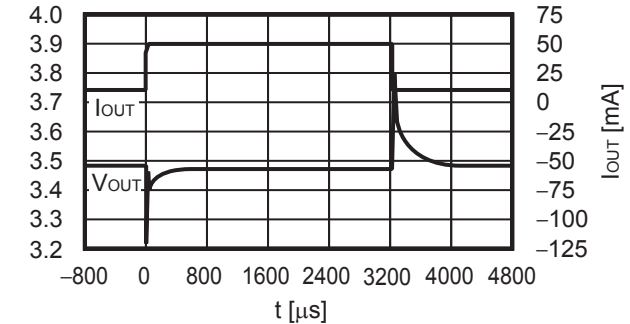

3. Ripple rejection ($T_a = +25^\circ\text{C}$)

3.1 $V_{OUT} = 1.0\text{ V}$

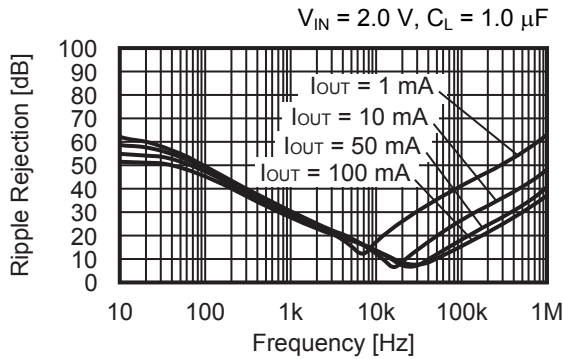

3.2 $V_{OUT} = 2.5\text{ V}$

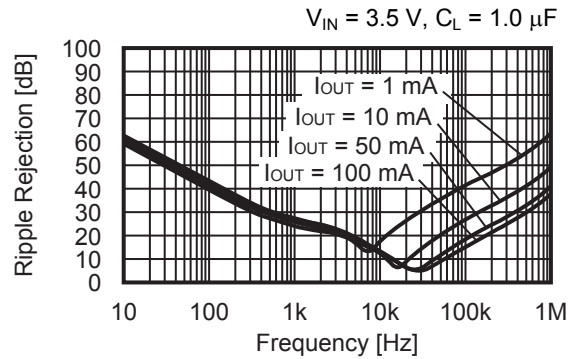

3.3 $V_{OUT} = 3.5\text{ V}$

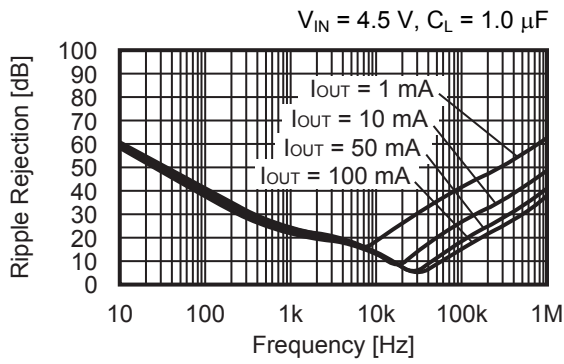

4. Example of equivalent series resistance vs. Output current characteristics ($T_a = +25^\circ\text{C}$)

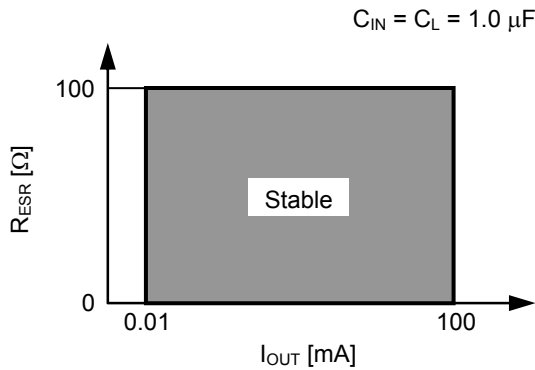
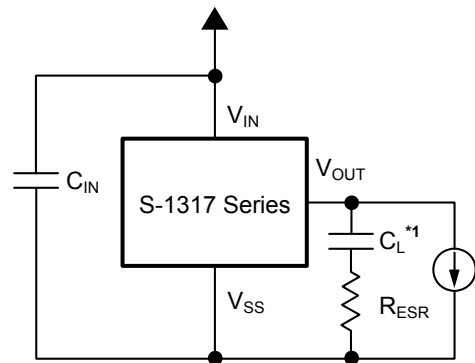

Figure 10



*1. C_L : TDK Corporation C3216X7R1H105K160AB

Figure 11

■ Power Dissipation

SOT-23-5

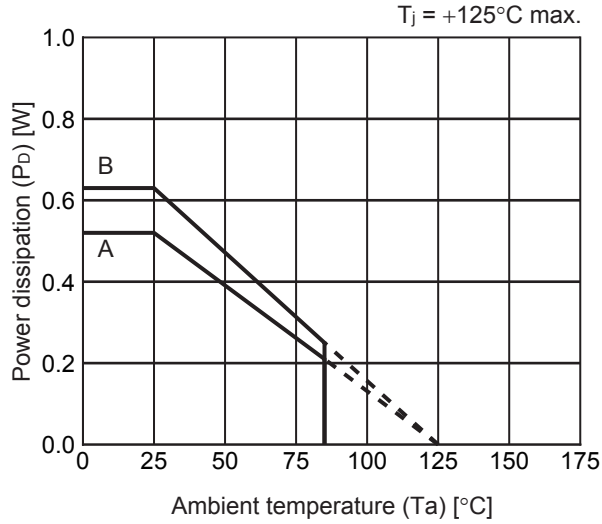

Board	Power Dissipation (P_D)
A	0.52 W
B	0.63 W
C	–
D	–
E	–

HSNT-4(1010)

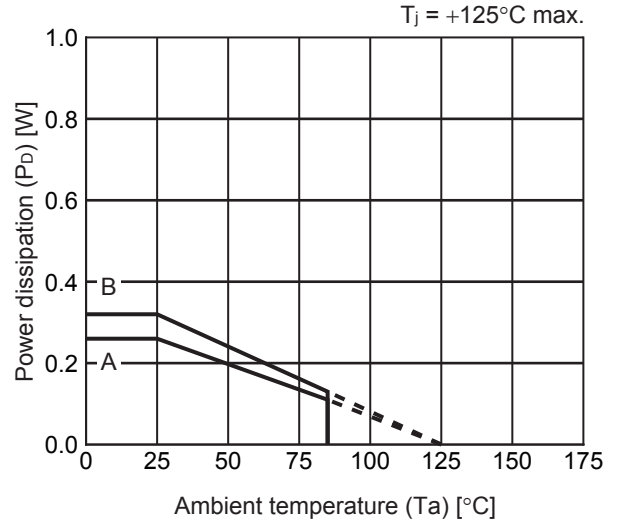

Board	Power Dissipation (P_D)
A	0.26 W
B	0.32 W
C	–
D	–
E	–

SOT-23-3/3S/5/6 Test Board

 IC Mount Area

(1) Board A



Item	Specification	
Size [mm]	114.3 x 76.2 x t1.6	
Material	FR-4	
Number of copper foil layer	2	
Copper foil layer [mm]	1	Land pattern and wiring for testing: t0.070
	2	-
	3	-
	4	74.2 x 74.2 x t0.070
Thermal via	-	

(2) Board B



Item	Specification	
Size [mm]	114.3 x 76.2 x t1.6	
Material	FR-4	
Number of copper foil layer	4	
Copper foil layer [mm]	1	Land pattern and wiring for testing: t0.070
	2	74.2 x 74.2 x t0.035
	3	74.2 x 74.2 x t0.035
	4	74.2 x 74.2 x t0.070
Thermal via	-	

No. SOT23x-A-Board-SD-2.0

HSNT-4(1010) Test Board

(1) Board A

 IC Mount Area

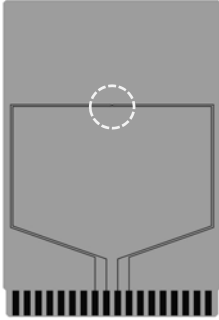

Item		Specification
Size [mm]		114.3 x 76.2 x t1.6
Material		FR-4
Number of copper foil layer		2
Copper foil layer [mm]	1	Land pattern and wiring for testing: t0.070
	2	-
	3	-
	4	74.2 x 74.2 x t0.070
Thermal via		-

(2) Board B

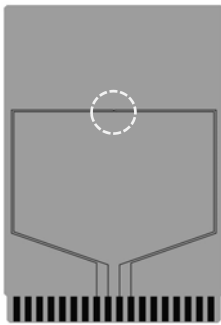

Item		Specification
Size [mm]		114.3 x 76.2 x t1.6
Material		FR-4
Number of copper foil layer		4
Copper foil layer [mm]	1	Land pattern and wiring for testing: t0.070
	2	74.2 x 74.2 x t0.035
	3	74.2 x 74.2 x t0.035
	4	74.2 x 74.2 x t0.070
Thermal via		-

No. HSNT4-B-Board-SD-1.0



No. MP005-A-P-SD-1.3

TITLE	SOT235-A-PKG Dimensions
No.	MP005-A-P-SD-1.3
ANGLE	
UNIT	mm
ABLIC Inc.	



Feed direction →

No. MP005-A-C-SD-2.1

TITLE	SOT235-A-Carrier Tape
No.	MP005-A-C-SD-2.1
ANGLE	
UNIT	mm
ABLIC Inc.	



Enlarged drawing in the central part



No. MP005-A-R-SD-1.1

TITLE	SOT235-A-Reel		
No.	MP005-A-R-SD-1.1		
ANGLE		QTY.	3,000
UNIT	mm		
ABLIC Inc.			

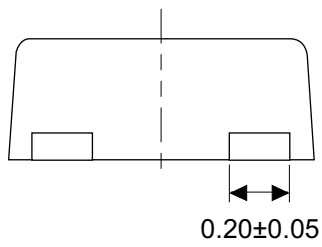
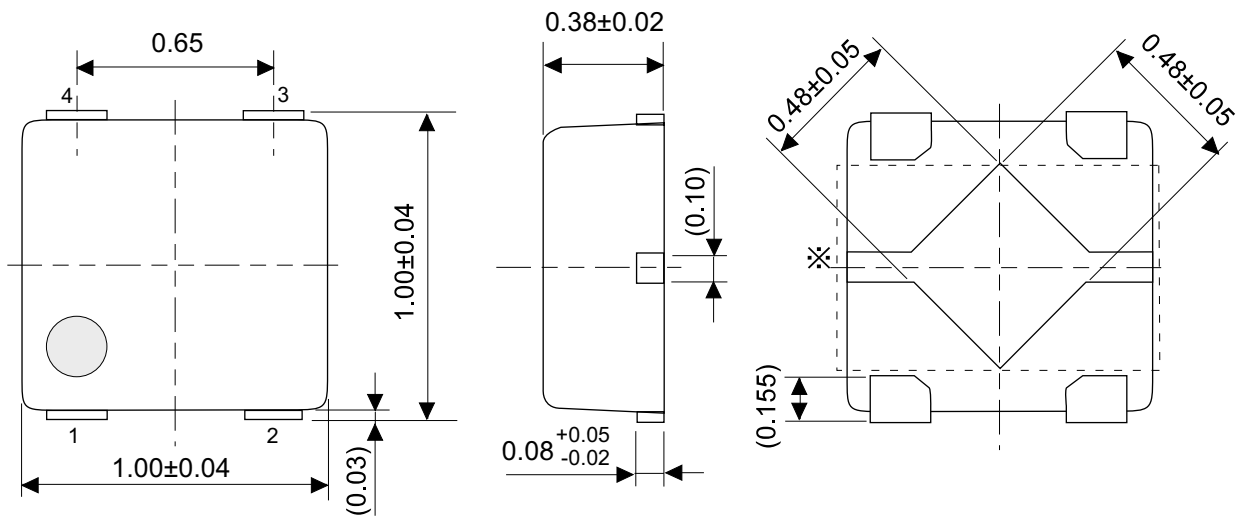

\ast The heat sink of back side has different electric potential depending on the product.
 Confirm specifications of each product.
 Do not use it as the function of electrode.

No. PL004-A-P-SD-1.1

TITLE	HSNT-4-B-PKG Dimensions
No.	PL004-A-P-SD-1.1
ANGLE	
UNIT	mm
ABLIC Inc.	

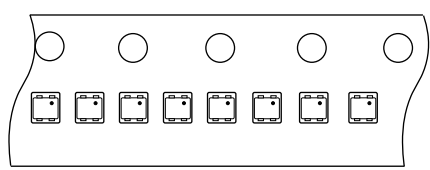
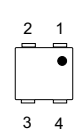
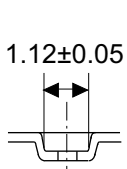
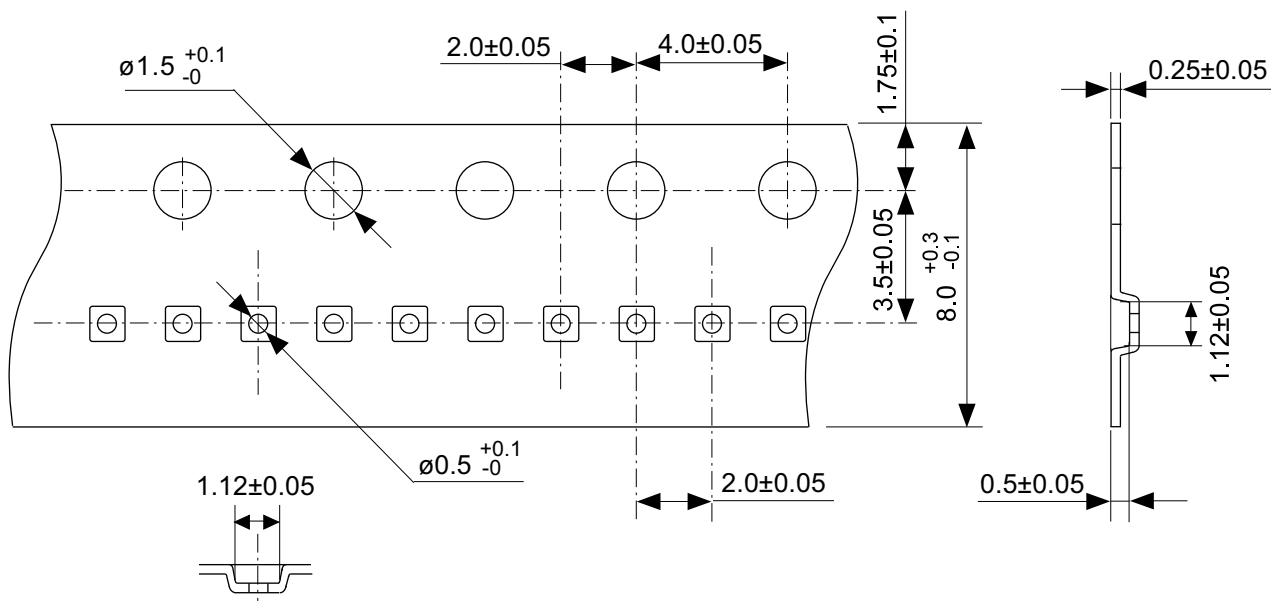

→
Feed direction

No. PL004-A-C-SD-2.0

TITLE	HSNT-4-B-Carrier Tape
No.	PL004-A-C-SD-2.0
ANGLE	
UNIT	mm
ABLIC Inc.	

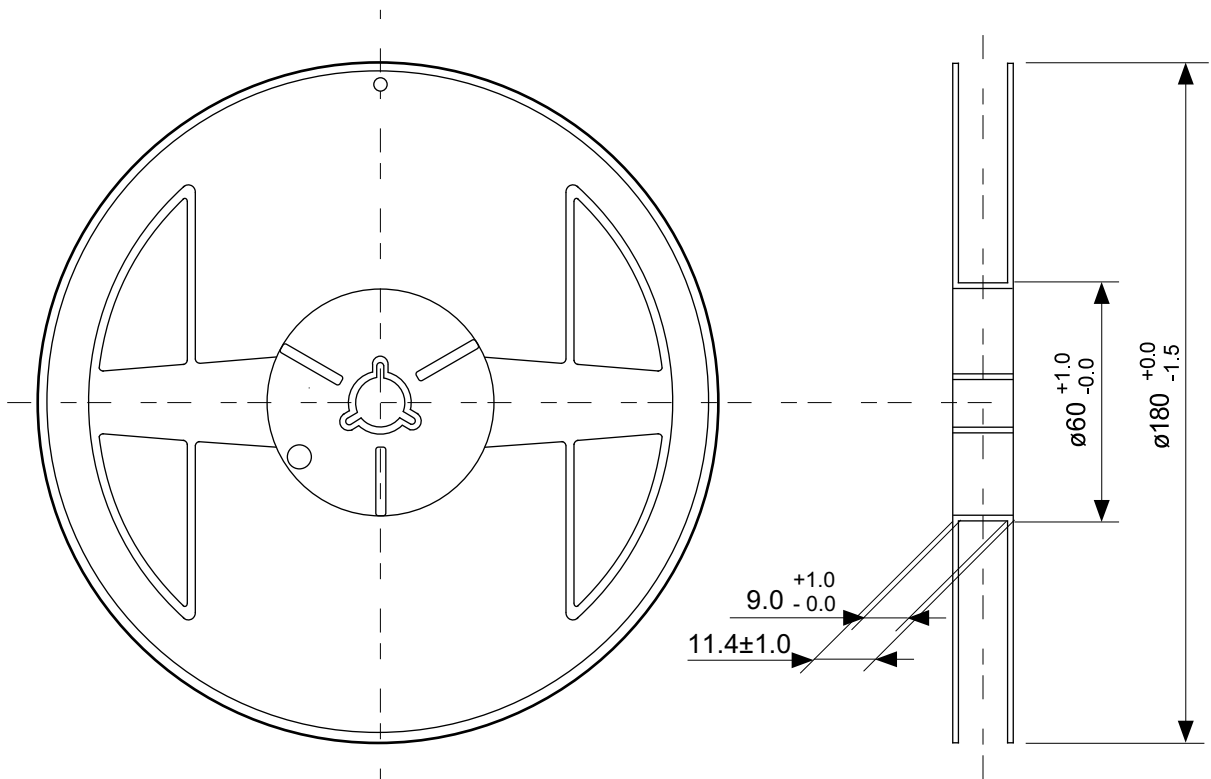

Enlarged drawing in the central part

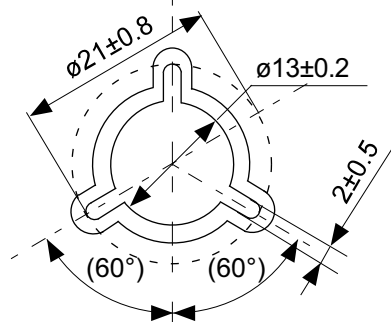

No. PL004-A-R-SD-1.0

TITLE	HSNT-4-B-Reel		
No.	PL004-A-R-SD-1.0		
ANGLE		QTY.	10,000
UNIT	mm		
ABLIC Inc.			

Land Pattern

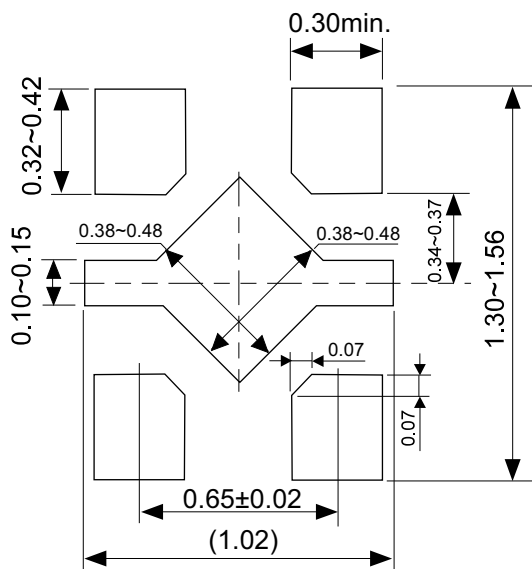

Caution It is recommended to solder the heat sink to a board in order to ensure the heat radiation.

注意 放熱性を確保する為に、PKGの裏面放熱板(ヒートシンク)を基板に半田付けする事を推奨いたします。

Metal Mask Pattern

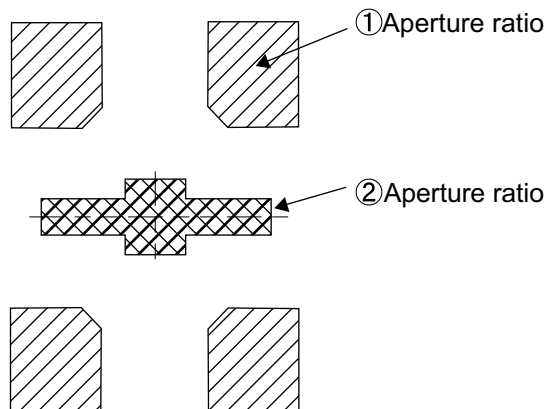

- Caution
- ① Mask aperture ratio of the lead mounting part is 100%.
 - ② Mask aperture ratio of the heat sink mounting part is 40%.
 - ③ Mask thickness: t0.10mm to 0.12 mm

- 注意
- ①リード実装部のマスク開口率は100%です。
 - ②放熱板実装のマスク開口率は40%です。
 - ③マスク厚み : t0.10mm ~ 0.12 mm

No. PL004-A-L-SD-2.0

TITLE	HSNT-4-B -Land Recommendation
No.	PL004-A-L-SD-2.0
ANGLE	
UNIT	mm
ABLIC Inc.	

Disclaimers (Handling Precautions)

1. All the information described herein (product data, specifications, figures, tables, programs, algorithms and application circuit examples, etc.) is current as of publishing date of this document and is subject to change without notice.
2. The circuit examples and the usages described herein are for reference only, and do not guarantee the success of any specific mass-production design.
ABLIC Inc. is not liable for any losses, damages, claims or demands caused by the reasons other than the products described herein (hereinafter "the products") or infringement of third-party intellectual property right and any other right due to the use of the information described herein.
3. ABLIC Inc. is not liable for any losses, damages, claims or demands caused by the incorrect information described herein.
4. Be careful to use the products within their ranges described herein. Pay special attention for use to the absolute maximum ratings, operation voltage range and electrical characteristics, etc.
ABLIC Inc. is not liable for any losses, damages, claims or demands caused by failures and / or accidents, etc. due to the use of the products outside their specified ranges.
5. Before using the products, confirm their applications, and the laws and regulations of the region or country where they are used and verify suitability, safety and other factors for the intended use.
6. When exporting the products, comply with the Foreign Exchange and Foreign Trade Act and all other export-related laws, and follow the required procedures.
7. The products are strictly prohibited from using, providing or exporting for the purposes of the development of weapons of mass destruction or military use. ABLIC Inc. is not liable for any losses, damages, claims or demands caused by any provision or export to the person or entity who intends to develop, manufacture, use or store nuclear, biological or chemical weapons or missiles, or use any other military purposes.
8. The products are not designed to be used as part of any device or equipment that may affect the human body, human life, or assets (such as medical equipment, disaster prevention systems, security systems, combustion control systems, infrastructure control systems, vehicle equipment, traffic systems, in-vehicle equipment, aviation equipment, aerospace equipment, and nuclear-related equipment), excluding when specified for in-vehicle use or other uses by ABLIC, Inc. Do not apply the products to the above listed devices and equipments.
ABLIC Inc. is not liable for any losses, damages, claims or demands caused by unauthorized or unspecified use of the products.
9. In general, semiconductor products may fail or malfunction with some probability. The user of the products should therefore take responsibility to give thorough consideration to safety design including redundancy, fire spread prevention measures, and malfunction prevention to prevent accidents causing injury or death, fires and social damage, etc. that may ensue from the products' failure or malfunction.
The entire system in which the products are used must be sufficiently evaluated and judged whether the products are allowed to apply for the system on customer's own responsibility.
10. The products are not designed to be radiation-proof. The necessary radiation measures should be taken in the product design by the customer depending on the intended use.
11. The products do not affect human health under normal use. However, they contain chemical substances and heavy metals and should therefore not be put in the mouth. The fracture surfaces of wafers and chips may be sharp. Be careful when handling these with the bare hands to prevent injuries, etc.
12. When disposing of the products, comply with the laws and ordinances of the country or region where they are used.
13. The information described herein contains copyright information and know-how of ABLIC Inc. The information described herein does not convey any license under any intellectual property rights or any other rights belonging to ABLIC Inc. or a third party. Reproduction or copying of the information from this document or any part of this document described herein for the purpose of disclosing it to a third-party is strictly prohibited without the express permission of ABLIC Inc.
14. For more details on the information described herein or any other questions, please contact ABLIC Inc.'s sales representative.
15. This Disclaimers have been delivered in a text using the Japanese language, which text, despite any translations into the English language and the Chinese language, shall be controlling.

2.4-2019.07