



LED Display Product Data Sheet LTC-4627JD

Spec No.: DS30-2001-093

Effective Date: 04/13/2011

Revision: A

LITE-ON DCC

RELEASE

BNS-OD-FC001/A4

LED DISPLAY**LTC-4627JD**
DATA SHEET

<u>ITEM</u>	<u>Description</u>	<u>By</u>	<u>DATE</u>
1	New Spec	Meg Huang	2001/03/16

FEATURES

- * 0.4inch (10.0mm) DIGIT HEIGHT.
- * CONTINUOUS UNIFORM SEGMENTS.
- * LOW POWER REQUIREMENT.
- * EXCELLENT CHARACTERS APPEARANCE.
- * HIGH BRIGHTNESS & HIGH CONTRAST.
- * WIDE VIEWING ANGLE.
- * SOLID STATE RELIABILITY.
- * CATEGORIZED FOR LUMINOUS INTENSITY.
- * **LEAD-FREE PACKAGE(ACCORDING TO ROHS)**

DESCRIPTION

The LTC-4627JD is a 0.4inch (10.0 mm) digit height quadruple digit seven-segment display. This device utilizes AllnGaP Hyper Red LED chips, which are made from AllnGaP on a non-transparent GaAs substrate, and has a gray face and white segments.

DEVICE

PART NO.	DESCRIPTION
AllnGaP HYPER RED	Multiplex Common Anode
LTC-4627JD	Rt. Hand Decimal

PACKAGE DIMENSIONS

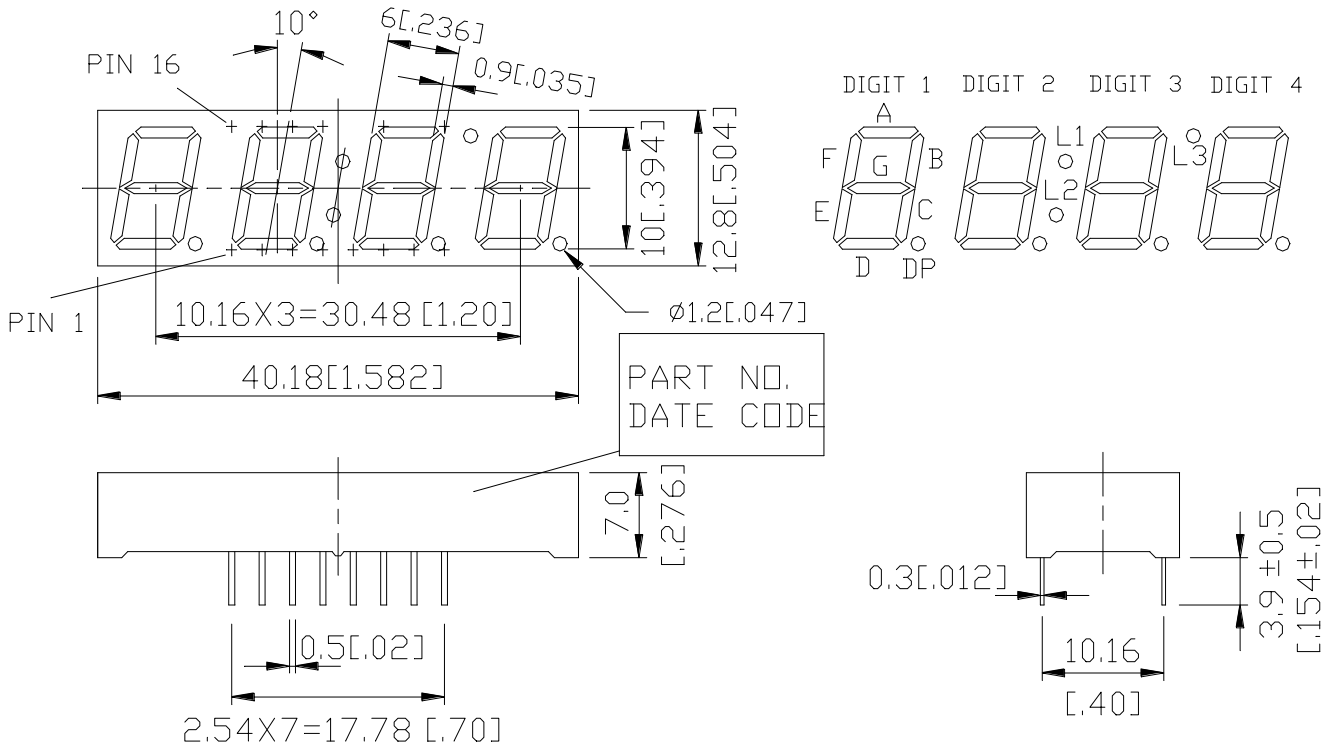

NOTES: All dimensions are in millimeters. Tolerances are ± 0.25 mm (0.01“) unless otherwise noted.

INTERNAL CIRCUIT DIAGRAM

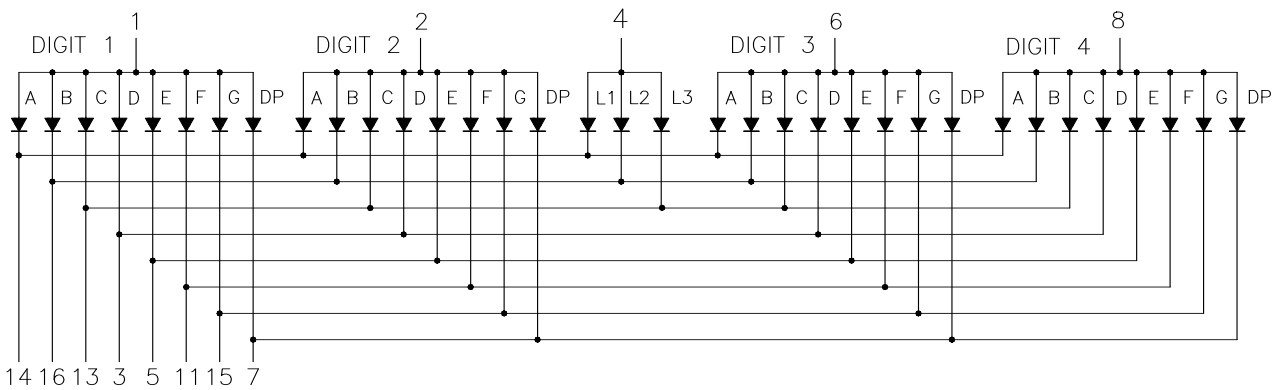

PIN CONNECTION

NO.	CONNECTION
1	COMMON ANODE DIGIT 1
2	COMMON ANODE DIGIT 2
3	CATHODE D
4	COMMON ANODE L1,L2,L3
5	CATHODE E
6	COMMON ANODE DIGIT 3
7	CATHODE DP
8	COMMON ANODE DIGIT 4
9	NO CONNECTION
10	NO PIN
11	CATHODE F
12	NO PIN
13	CATHODE C,L3
14	CATHODE A,L1
15	CATHODE G
16	CATHODE B,L2

ABSOLUTE MAXIMUM RATING AT Ta=25°C

PARAMETER	MAXIMUM RATING	UNIT
Power Dissipation Per Segment	70	mW
Peak Forward Current Per Segment (1/10 Duty Cycle, 0.1ms Pulse Width)	90	mA
Continuous Forward Current Per Segment Derating Linear From 25°C Per Segment	25 0.33	mA mA/°C
Operating Temperature Range	-35°C to +85°C	
Storage Temperature Range	-35°C to +85°C	
Solder Temperature: max 260°C for max 3sec at 1.6mm[1/16inch] below seating plane.		

ELECTRICAL / OPTICAL CHARACTERISTICS AT Ta=25°C

PARAMETER	SYMBOL	MIN.	TYP.	MAX.	UNIT	TEST CONDITION
Average Luminous Intensity	I _v	200	650		μcd	I _F =1mA
Peak Emission Wavelength	λ _p		650		nm	I _F =20mA
Spectral Line Half-Width	Δλ		20		nm	I _F =20mA
Dominant Wavelength	λ _d		639		nm	I _F =20mA
Forward Voltage Per Segment	V _F		2.1	2.6	V	I _F =20mA
Reverse Current Per Segment ⁽²⁾	I _R			100	μA	V _R =5V
Luminous Intensity Matching Ratio	I _{v-m}			2:1		I _F =1mA

Note:

- Luminous intensity is measured with a light sensor and filter combination that approximates the CIE (Commision Internationale De L'Eclairage) eye-response curve.
- Reverse voltage is only for IR test. It can not continue to operate at this situation.

TYPICAL ELECTRICAL / OPTICAL CHARACTERISTIC CURVES

(25°C Ambient Temperature Unless Otherwise Noted)

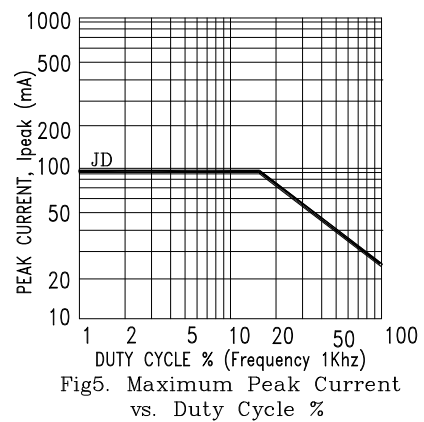
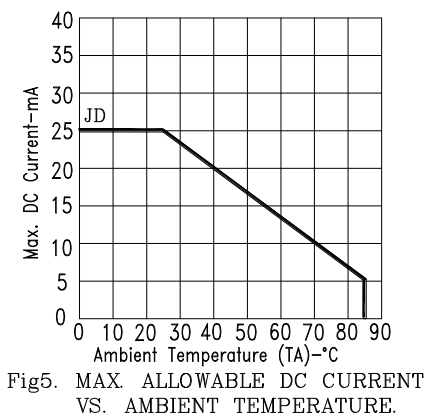
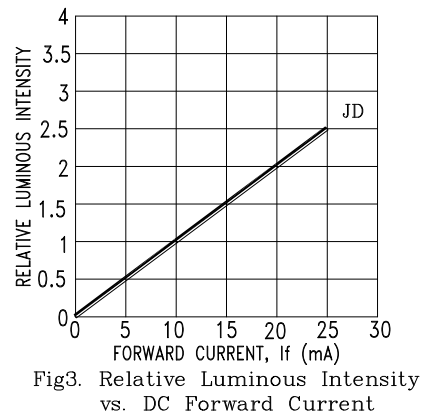
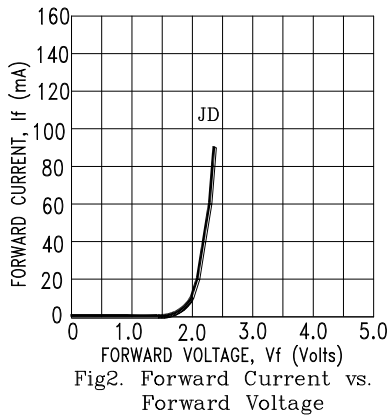
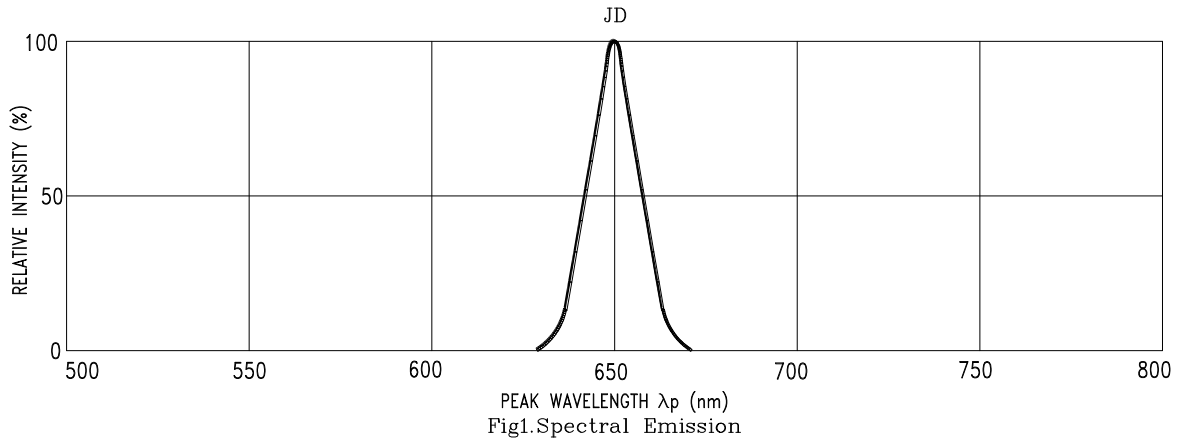

NOTE : JD=AlInGaP HYPER RED