

SELECTION GUIDE

The output voltage, auto-discharge function⁽¹⁾, package for the ICs can be selected at the user's request.

Selection Guide

Product Name	Package	Quantity per Reel	Pb Free	Halogen Free
RP112Kxx1*-TR	DFN(PL)1010-4	10,000 pcs	Yes	Yes
RP112Qxx2*-TR-FE	SC-88A	3,000 pcs	Yes	Yes
RP112Nxx1*-TR-FE	SOT-23-5	3,000 pcs	Yes	Yes

xx: Set output voltage (V_{SET}) is selectable from 1.2 V to 4.8 V in 0.1 V step.

The second decimal point of the voltage is described as below.

1.25 V: RP112x12x*5

1.85 V: RP112x18x*5

2.85 V: RP112x28x*5

*: Selections of CE pin polarity and Auto-discharge function are as shown below:

(B) CE pin polarity: "H" active, Auto-discharge function: No

(D) CE pin polarity: "H" active, Auto-discharge function: Yes

BLOCK DIAGRAMS

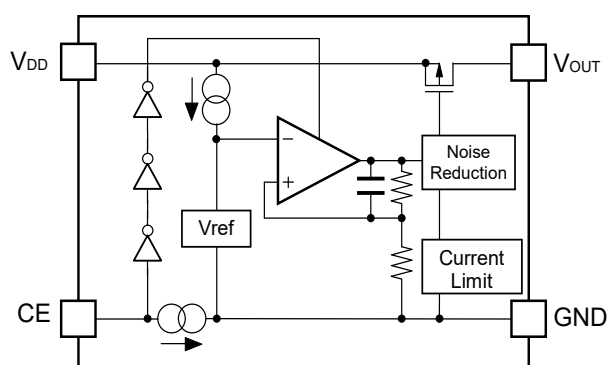

RP112xxxxB Block Diagram

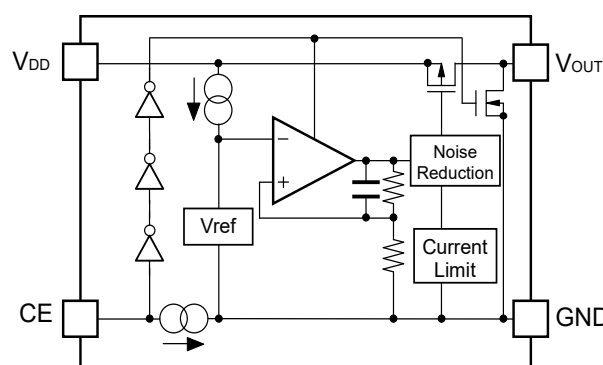

RP112xxxxD Block Diagram

⁽¹⁾ Auto-discharge function quickly lowers the output voltage to 0 V by releasing the electrical charge in the external capacitor when the chip enable signal is switched from the active mode to the standby mode.

PIN DESCRIPTIONS

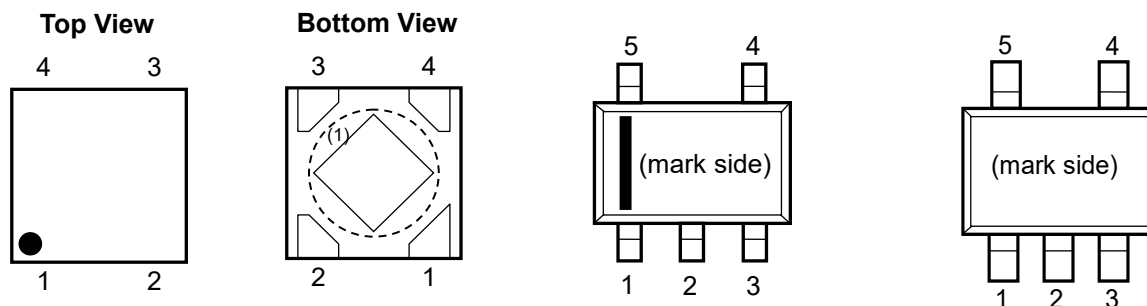

DFN(PL)1010-4 Pin Configuration

SC-88A Pin Configuration

SOT-23-5 Pin Configuration

DFN(PL)1010-4 Pin Description

Pin No.	Symbol	Description
1	V _{OUT}	Output Pin
2	GND	Ground Pin
3	CE	Chip Enable Pin ("H" Active)
4	V _{DD}	Input Pin

SC-88A Pin Description

Pin No	Symbol	Pin Description
1	V _{DD}	Input Pin
2	GND	Ground Pin
3	CE	Chip Enable Pin ("H" Active)
4	NC	No Connection
5	V _{OUT}	Output Pin

SOT-23-5 Pin Description

Pin No	Symbol	Pin Description
1	V _{DD}	Input Pin
2	GND	Ground Pin
3	CE	Chip Enable Pin ("H" Active)
4	NC	No Connection
5	V _{OUT}	Output Pin

⁽¹⁾ Tab is GND level (They are connected to the reverse side of this IC). The tab is better to be connected to the GND, but leaving it open is also acceptable.

ABSOLUTE MAXIMUM RATINGS

Absolute Maximum Ratings

Symbol	Item		Rating	Unit	
V _{IN}	Input Voltage		6.0	V	
V _{CE}	Input Voltage (CE Pin)		6.0	V	
V _{OUT}	Output Voltage		-0.3 to V _{IN} + 0.3	V	
I _{OUT}	Output Current		180	mA	
P _D	Power Dissipation ⁽¹⁾	(DFN(PL)1010-4)	JEDEC STD. 51-7 Test Land Pattern	800	mW
		SC-88A	Standard Test Land Pattern	380	
		SOT-23-5	JEDEC STD. 51-7 Test Land Pattern	660	
T _j	Junction Temperature Range		-40 to 125	°C	
T _{stg}	Storage Temperature Range		-55 to 125	°C	

ABSOLUTE MAXIMUM RATINGS

Electronic and mechanical stress momentarily exceeded absolute maximum ratings may cause the permanent damages and may degrade the life time and safety for both device and system using the device in the field. The functional operation at or over these absolute maximum ratings is not assured.

RECOMMENDED OPERATING CONDITIONS

Recommended Operating Conditions

Symbol	Item	Rating	Unit
V _{IN}	Input Voltage	2.0 to 5.25	V
T _a	Operating Temperature	-40 to 85	°C

RECOMMENDED OPERATING CONDITIONS

All of electronic equipment should be designed that the mounted semiconductor devices operate within the recommended operating conditions. The semiconductor devices cannot operate normally over the recommended operating conditions, even if when they are used over such conditions by momentary electronic noise or surge. And the semiconductor devices may receive serious damage when they continue to operate over the recommended operating conditions.

⁽¹⁾ Refer to *POWEWR DISSIPATION* for detailed information.

ELECTRICAL CHARACTERISTICS

Unless otherwise noted, $V_{IN} = 5.25\text{ V}$ ($V_{OUT} \geq 4.1\text{ V}$), $V_{IN} = \text{Set } V_{OUT} + 1.0\text{ V}$ ($1.5\text{ V} < V_{OUT} < 4.1\text{ V}$), $V_{IN} = 2.5\text{ V}$ ($V_{OUT} \leq 1.5\text{ V}$), $I_{OUT} = 1\text{ mA}$, $C_{IN} = C_{OUT} = 1.0\text{ }\mu\text{F}$

The specifications surrounded by are guaranteed by design engineering at $-40^\circ\text{C} \leq T_a \leq 85^\circ\text{C}$.

RP112xxxxB/D Electrical Characteristics

($T_a = 25^\circ\text{C}$)

Symbol	Item	Conditions	Min.	Typ.	Max.	Unit	
V_{OUT}	Output Voltage	$T_a = 25^\circ\text{C}$	$V_{OUT} \geq 2.0\text{ V}$	x0.99		x1.01	V
			$V_{OUT} < 2.0\text{ V}$	-20		+20	mV
		$-40^\circ\text{C} \leq T_a \leq 85^\circ\text{C}$	$V_{OUT} \geq 2.0\text{ V}$	x0.985		x1.015	V
			$V_{OUT} < 2.0\text{ V}$	-30		+30	mV
I_{OUT}	Output Current		150			mA	
$\Delta V_{OUT}/\Delta I_{OUT}$	Load Regulation	$1\text{ mA} \leq I_{OUT} \leq 150\text{ mA}$	-14	0	14	mV	
V_{DIF}	Dropout Voltage	<i>Refer to Product-specific Electrical Characteristics</i>					
I_{SS}	Supply Current	$I_{OUT} = 0\text{ mA}$	$V_{OUT} \geq 4.1\text{ V}$		80	100	μA
			$V_{OUT} < 4.1\text{ V}$		75		
$I_{standby}$	Standby Current	$V_{CE} = 0\text{ V}$		0.1	1.0	μA	
$\Delta V_{OUT}/\Delta V_{IN}$	Line Regulation	$\text{Set } V_{OUT} + 0.3\text{ V} \leq V_{IN} \leq 5.25\text{ V}$	$V_{OUT} \geq 4.1\text{ V}$		0.02	0.10	$\%/V$
		$\text{Set } V_{OUT} + 0.5\text{ V} \leq V_{IN} \leq 5.0\text{ V}$	$1.7\text{ V} \leq V_{OUT} < 4.1\text{ V}$				
		$2.2\text{ V} \leq V_{IN} \leq 5.0\text{ V}$	$V_{OUT} < 1.7\text{ V}$				
RR	Ripple Rejection	Ripple 0.2 V _{p-p} , $I_{OUT} = 30\text{ mA}$, $V_{IN} = 5.25\text{ V}$ ($V_{OUT} \geq 4.1\text{ V}$), $V_{IN} = \text{Set } V_{OUT} + 1.0\text{ V}$ ($V_{OUT} < 4.1\text{ V}$)	$f = 1\text{ kHz}$		80		dB
			$f = 10\text{ kHz}$		75		
			$f = 100\text{ kHz}$		65		
V_{IN}	Input Voltage ⁽¹⁾		2.0		5.25	V	
$\Delta V_{OUT}/\Delta T_a$	Output Voltage Temperature Coefficient	$-40^\circ\text{C} \leq T_a \leq 85^\circ\text{C}$		± 30		ppm/ $^\circ\text{C}$	
I_{SC}	Short Current Limit	$V_{OUT} = 0\text{ V}$		40		mA	
I_{PD}	CE Pull-down Current			0.3	0.6	μA	
V_{CEH}	CE Input Voltage "H"		1.0			V	
V_{CEL}	CE Input Voltage "L"				0.4	V	

All test categories were tested on the products under the pulse load condition ($T_j \approx T_a = 25^\circ\text{C}$) except Output Noise, Ripple Rejection, and Output Voltage Temperature Coefficient.

⁽¹⁾ The maximum input voltage (Electrical Characteristics) is 5.25 V. If, for any reason the maximum input voltage exceeds 5.25 V, it has to be no more than 5.5 V with 500 hrs of the total operating time.

ELECTRICAL CHARACTERISTICS (continued)

Unless otherwise noted, $V_{IN} = 5.25\text{ V}$ ($V_{OUT} \geq 4.1\text{ V}$), $V_{IN} = \text{Set } V_{OUT} + 1.0\text{ V}$ ($1.5\text{ V} < V_{OUT} < 4.1\text{ V}$),
 $V_{IN} = 2.5\text{ V}$ ($V_{OUT} \leq 1.5\text{ V}$), $I_{OUT} = 1\text{ mA}$, $C_{IN} = C_{OUT} = 1.0\text{ }\mu\text{F}$

The specifications surrounded by are guaranteed by design engineering at $-40^{\circ}\text{C} \leq T_a \leq 85^{\circ}\text{C}$.

RP112xxxxB/D Electrical Characteristics

(Ta = 25°C)

Symbol	Item	Conditions	Min.	Typ.	Max.	Unit
en	Output Noise	BW = 10 Hz to 100 kHz, $I_{OUT} = 30\text{ mA}$		10		μVrms
R_{LOW}	Auto-discharge Nch Tr. ON Resistance (RP112xxxxD only)	$V_{IN} = 4.0\text{ V}$, $V_{CE} = 0\text{ V}$		60		Ω

All test categories were tested on the products under the pulse load condition ($T_j \approx T_a = 25^{\circ}\text{C}$) except Output Noise, Ripple Rejection, and Output Voltage Temperature Coefficient.

The specifications surrounded by are guaranteed by design engineering at $-40^{\circ}\text{C} \leq T_a \leq 85^{\circ}\text{C}$.

Product-specific Electrical Characteristics

Product Name	V _{OUT}						V _{DIF}	
	T _a = 25°C			-40°C ≤ T _a ≤ 85°C			T _a = 25°C	
	Min.	Typ.	Max.	Min.	Typ.	Max.	Typ.	Max.
RP112x12xx	1.180	1.20	1.220	1.170	1.20	1.230	0.39	0.80
RP112x12xx5	1.230	1.25	1.270	1.220	1.25	1.280	0.39	0.80
RP112x13xx	1.280	1.30	1.320	1.270	1.30	1.330	0.37	0.70
RP112x14xx	1.380	1.40	1.420	1.370	1.40	1.430	0.34	0.60
RP112x15xx	1.480	1.50	1.520	1.470	1.50	1.530	0.32	0.50
RP112x16xx	1.580	1.60	1.620	1.570	1.60	1.630	0.32	0.50
RP112x17xx	1.680	1.70	1.720	1.670	1.70	1.730	0.29	0.41
RP112x18xx	1.780	1.80	1.820	1.770	1.80	1.830	0.29	0.41
RP112x18xx5	1.830	1.85	1.870	1.820	1.85	1.880	0.29	0.41
RP112x19xx	1.880	1.90	1.920	1.870	1.90	1.930	0.29	0.41
RP112x20xx	1.980	2.00	2.020	1.970	2.00	2.030	0.25	0.36
RP112x21xx	2.079	2.10	2.121	2.069	2.10	2.132	0.25	0.36
RP112x22xx	2.178	2.20	2.222	2.167	2.20	2.233	0.25	0.36
RP112x23xx	2.277	2.30	2.323	2.266	2.30	2.335	0.25	0.36
RP112x24xx	2.376	2.40	2.424	2.364	2.40	2.436	0.25	0.36
RP112x25xx	2.475	2.50	2.525	2.463	2.50	2.538	0.22	0.31
RP112x26xx	2.574	2.60	2.626	2.561	2.60	2.639	0.22	0.31
RP112x27xx	2.673	2.70	2.727	2.660	2.70	2.741	0.22	0.31
RP112x28xx	2.772	2.80	2.828	2.758	2.80	2.842	0.20	0.28
RP112x28xx5	2.822	2.85	2.879	2.807	2.85	2.893	0.20	0.28
RP112x29xx	2.871	2.90	2.929	2.857	2.90	2.944	0.20	0.28
RP112x29xx5	2.921	2.95	2.980	2.906	2.95	2.994	0.20	0.28
RP112x30xx	2.970	3.00	3.030	2.955	3.00	3.045	0.20	0.28
RP112x31xx	3.069	3.10	3.131	3.054	3.10	3.147	0.20	0.28
RP112x31xx5	3.119	3.15	3.182	3.103	3.15	3.197	0.20	0.28
RP112x32xx	3.168	3.20	3.232	3.152	3.20	3.248	0.20	0.28
RP112x33xx	3.267	3.30	3.333	3.251	3.30	3.350	0.20	0.28
RP112x34xx	3.366	3.40	3.434	3.349	3.40	3.451	0.20	0.28
RP112x35xx	3.465	3.50	3.535	3.448	3.50	3.553	0.20	0.28
RP112x36xx	3.564	3.60	3.636	3.546	3.60	3.654	0.20	0.28
RP112x37xx	3.663	3.70	3.737	3.645	3.70	3.756	0.20	0.28
RP112x38xx	3.762	3.80	3.838	3.743	3.80	3.857	0.20	0.28
RP112x39xx	3.861	3.90	3.939	3.842	3.90	3.959	0.20	0.28
RP112x40xx	3.960	4.00	4.040	3.940	4.00	4.060	0.20	0.28
RP112x41xx	4.059	4.10	4.141	4.039	4.10	4.162	0.20	0.28
RP112x42xx	4.158	4.20	4.242	4.137	4.20	4.263	0.20	0.28
RP112x43xx	4.257	4.30	4.343	4.236	4.30	4.365	0.20	0.28
RP112x44xx	4.356	4.40	4.444	4.334	4.40	4.466	0.20	0.28
RP112x45xx	4.455	4.50	4.545	4.433	4.50	4.568	0.20	0.28
RP112x46xx	4.554	4.60	4.646	4.531	4.60	4.669	0.20	0.28
RP112x47xx	4.653	4.70	4.747	4.630	4.70	4.771	0.20	0.28
RP112x48xx	4.752	4.80	4.848	4.728	4.80	4.872	0.20	0.28

APPLICATION INFORMATION

TYPICAL APPLICATIONS

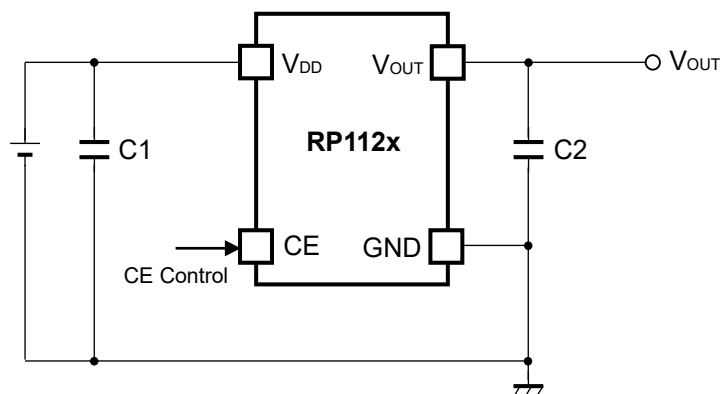

External Components

Symbol	Description
C1 (C _{IN})	1.0 μ F, Ceramic Capacitor, GRM155B31A105KE15, MURATA
C2 (C _{OUT})	1.0 μ F, Ceramic Capacitor, GRM155B31A105KE15, MURATA

TECHNICAL NOTES

Phase Compensation

In these ICs, phase compensation is made for securing stable operation even if the load current is varied. For this purpose, use a 1.0 μ F or more capacitor C2.

In case of using a tantalum capacitor, the output may be unstable due to inappropriate ESR. Therefore, the full range of operating conditions for the capacitor in the application should be considered.

PCB Layout

The high impedances of V_{DD} and GND could be a reason for the noise pickup and unstable operation. Therefore, it is imperative that the impedances of V_{DD} and GND be the lowest possible. Also, place a 1.0 μ F or more capacitor (C1) between V_{DD} pin and GND pin as close as possible to each other.

As for C2 output capacitor that is used for phase compensation, place it between V_{OUT} pin and GND as close as possible to each other (Refer to *TYPICAL APPLICATIONS*).

TYPICAL CHARACTERISTICS

Typical Characteristics are intended to be used as reference data; they are not guaranteed.

1) Output Voltage vs. Output Current (C1 = Ceramic 1.0 μ F, C2 = Ceramic 1.0 μ F, Ta = 25°C)

RP112x12xx

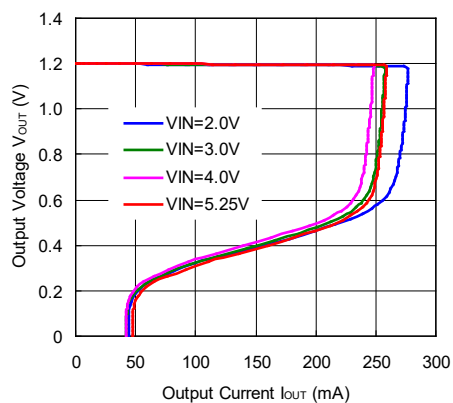

RP112x28xx

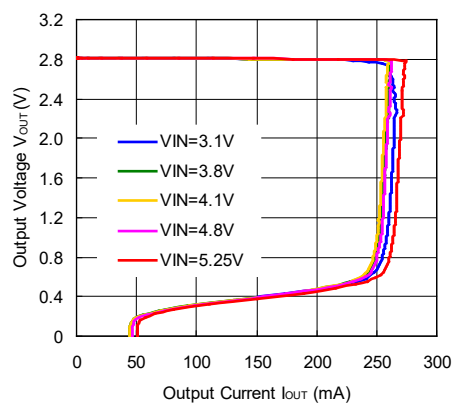

RP112x40xx

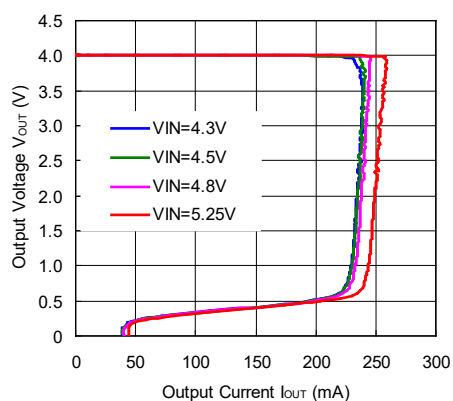

RP112x48xx

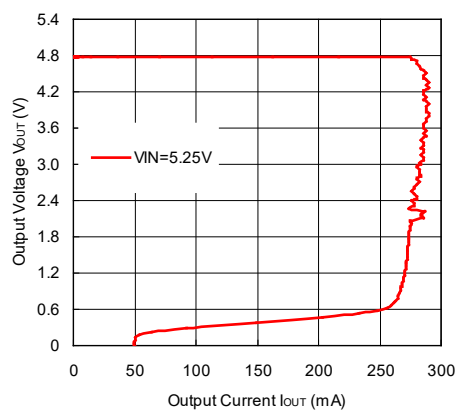

2) Output Voltage vs. Input Voltage (C1 = Ceramic 1.0 μ F, C2 = Ceramic 1.0 μ F, Ta = 25°C)

RP112x12xx

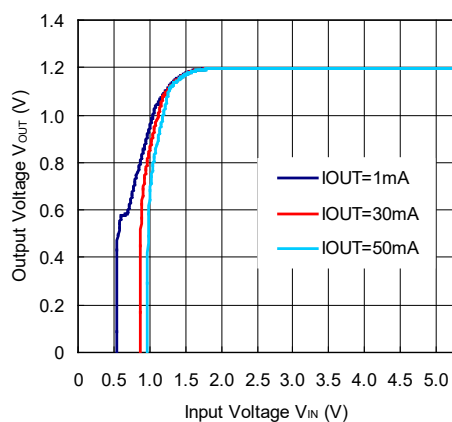

RP112x28xx

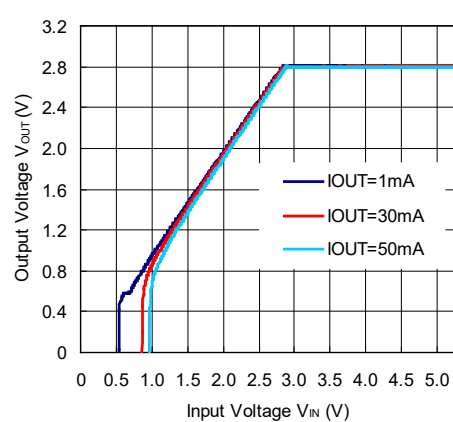

RP112x40xx

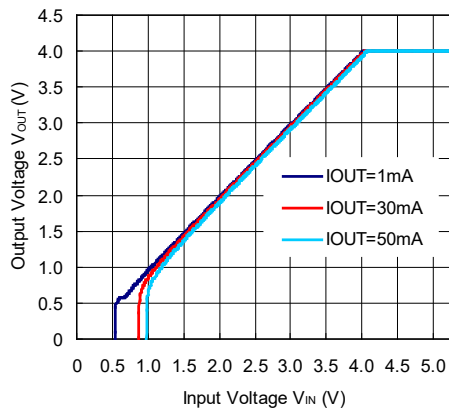

RP112x48xx

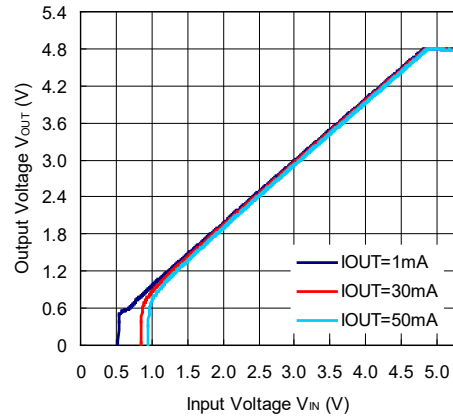

3) Supply Current vs. Input Voltage (C1 = Ceramic 1.0 μ F, C2 = Ceramic 1.0 μ F, Ta = 25°C)

RP112x12xx

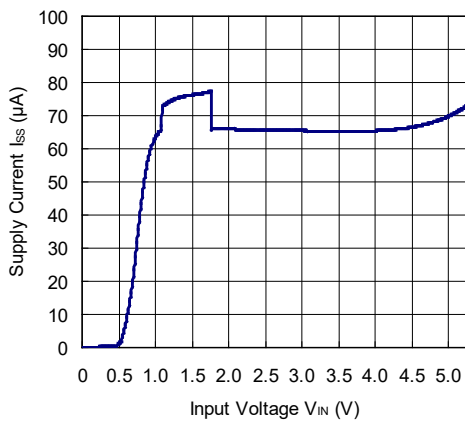

RP112x28xx

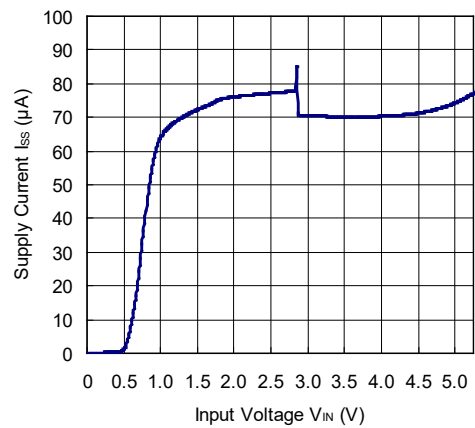

RP112x40xx

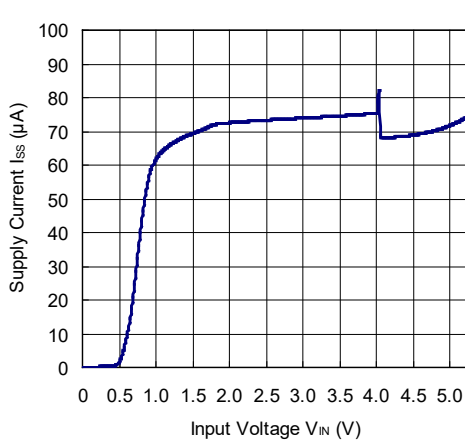

RP112x48xx

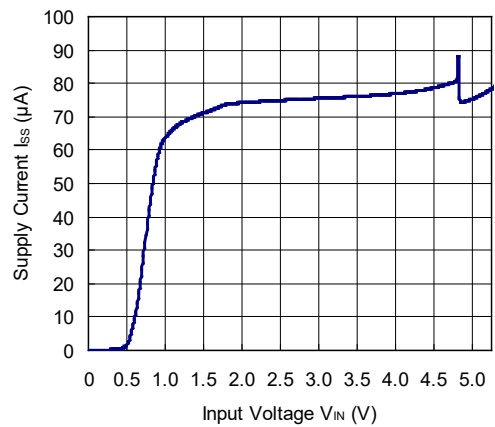

4) Output Voltage vs. Temperature (C1 = Ceramic 1.0 μ F, C2 = Ceramic 1.0 μ F, I_{OUT} = 1 mA)

RP112x12xx

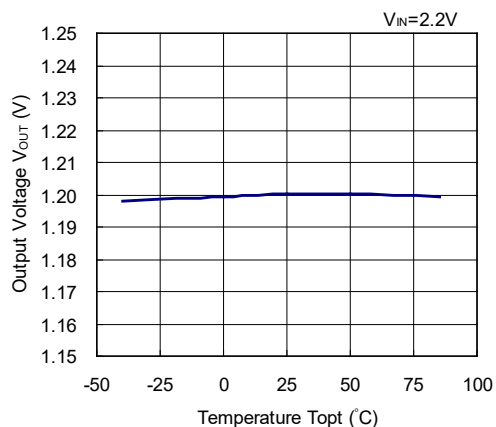

RP112x28xx

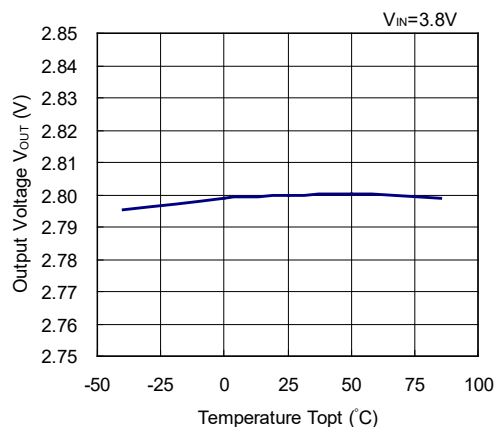

RP112x40xx

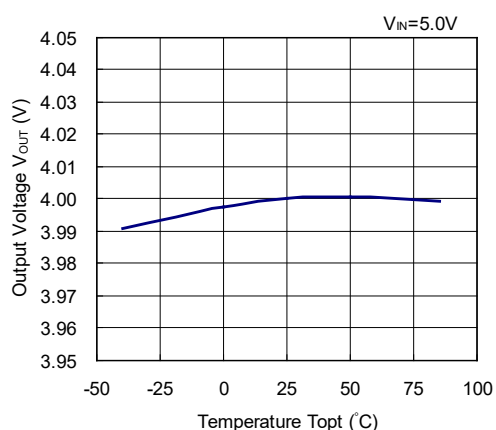

RP112x48xx

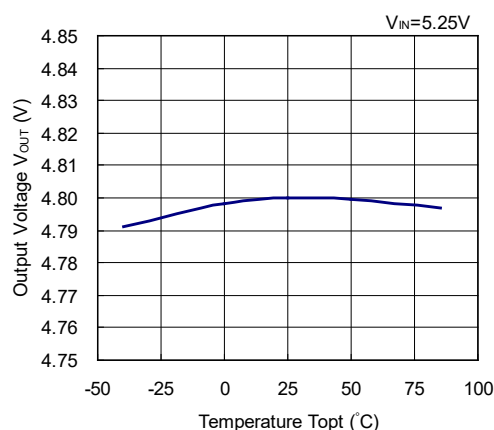

5) Supply Current vs. Temperature (C1 = Ceramic 1.0 μ F, C2 = Ceramic 1.0 μ F, I_{OUT} = 0 mA)

RP112x12xx

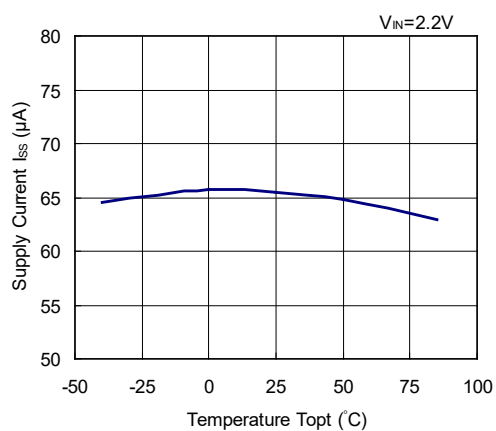

RP112x28xx

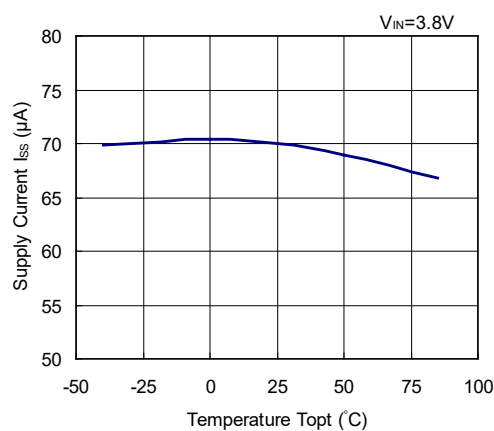

RP112x40xx

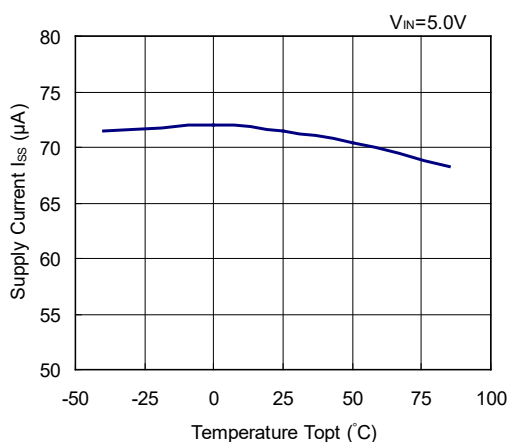

RP112x48xx

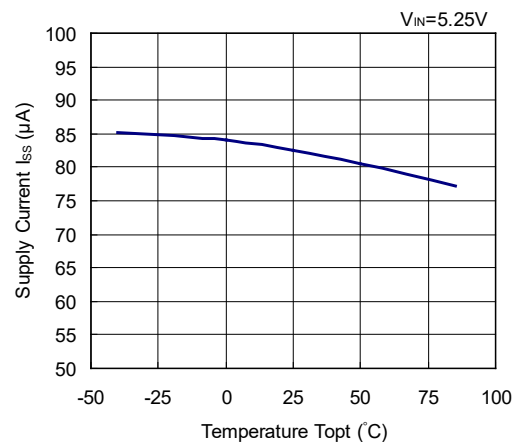

6) Dropout Voltage vs. Output Current (C1 = Ceramic 1.0 µF, C2 = Ceramic 1.0 µF)

RP112x12xx

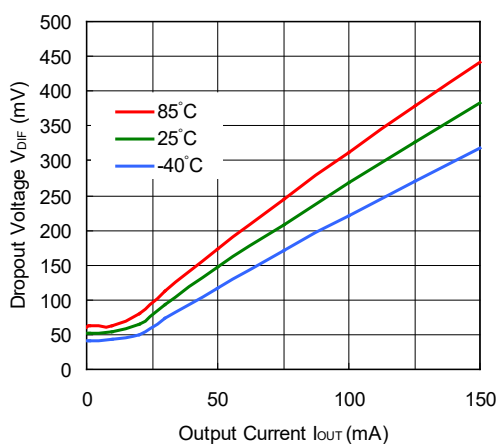

RP112x28xx

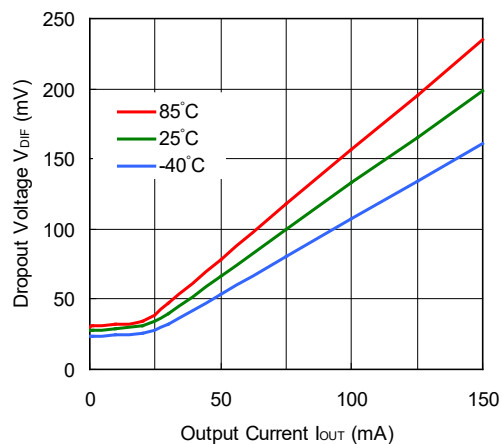

RP112x40xx

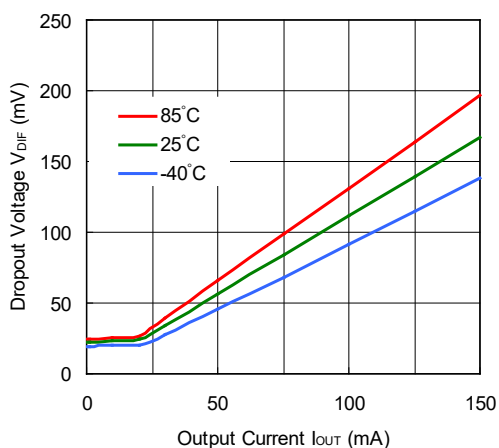

RP112x48xx

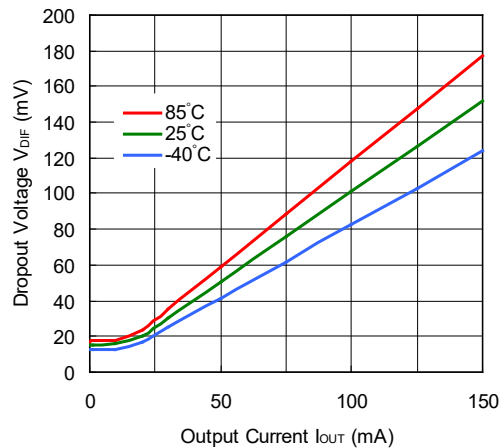

7) Dropout Voltage vs. Set Output Voltage (C1 = Ceramic 1.0 μ F, C2 = Ceramic 1.0 μ F, Ta = 25°C)

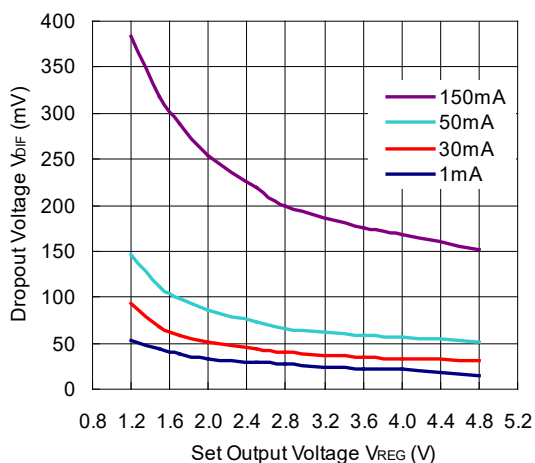

8) Dropout Voltage vs. Temperature (C1 = Ceramic 1.0 μ F, C2 = Ceramic 1.0 μ F)

RP112x12xx

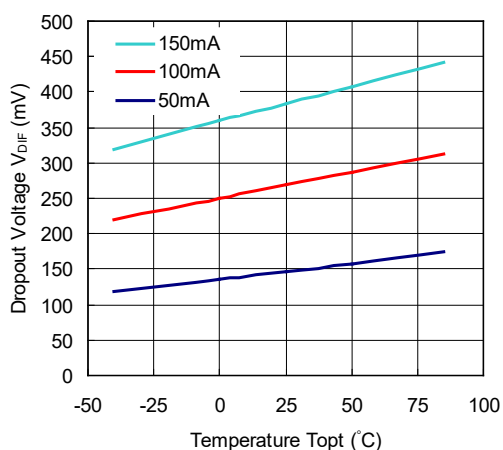

RP112x28xx

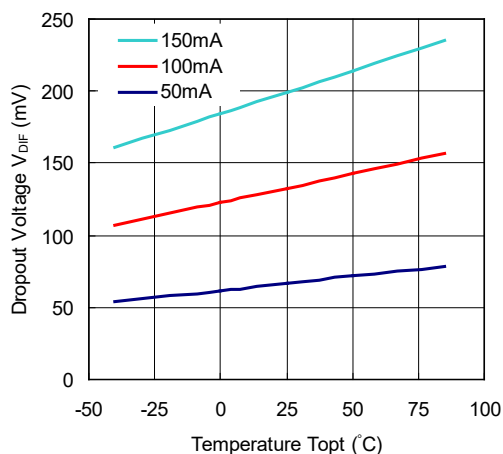

RP112x40xx

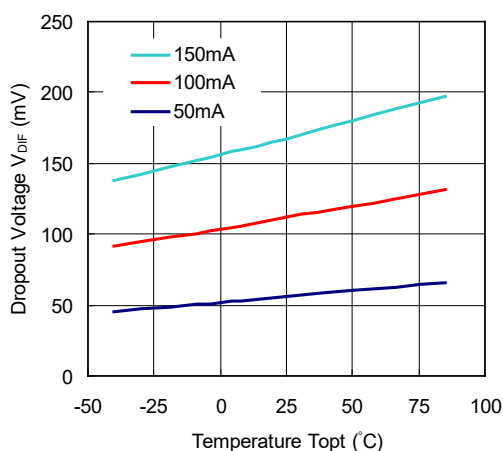

RP112x48xx

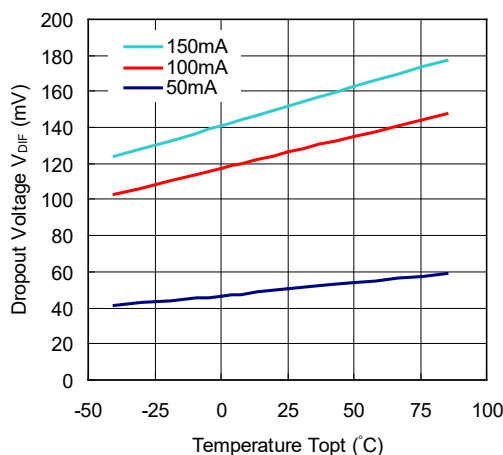

9) Ripple Rejection vs. Input Voltage (C1 = none, C2 = Ceramic 1.0 μ F, Ripple = 0.2 Vp-p, Ta = 25°C)

RP112x12xx

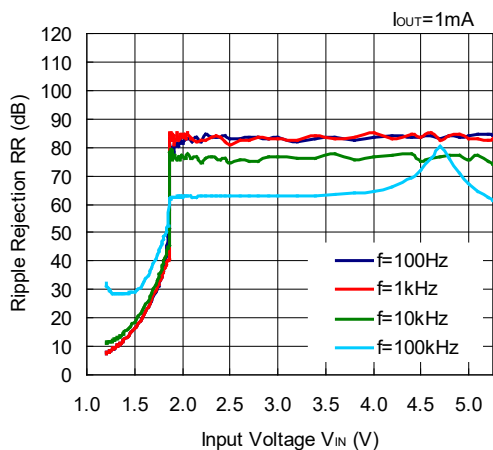

RP112x12xx

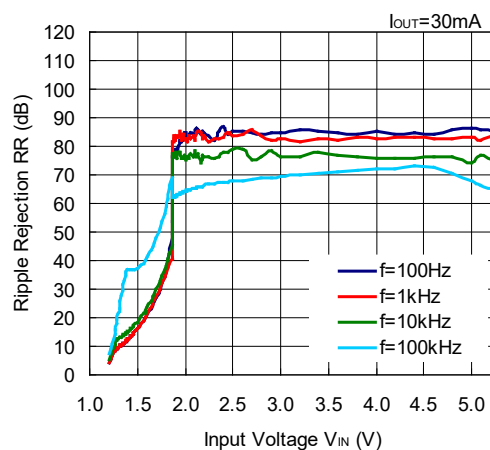

RP112x28xx

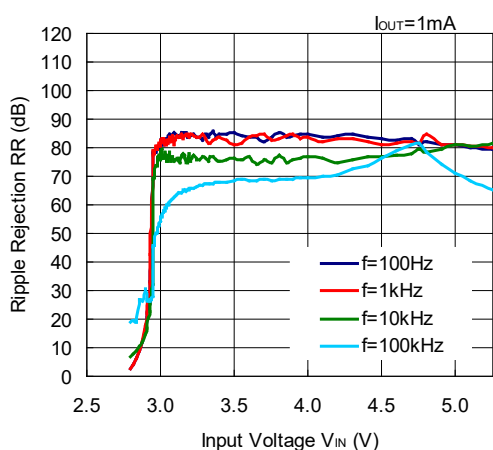

RP112x28xx

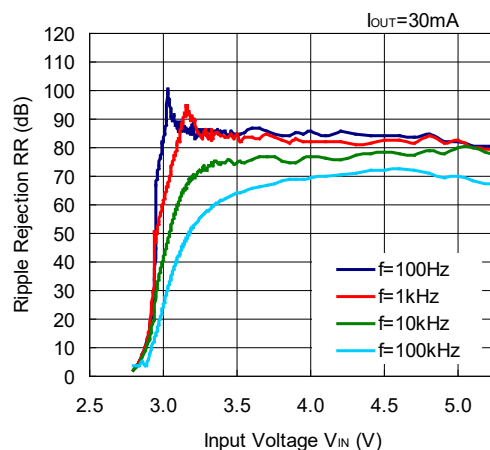

RP112x40xx

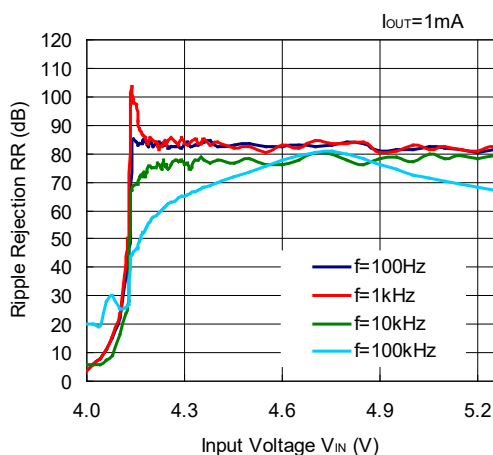

RP112x40xx

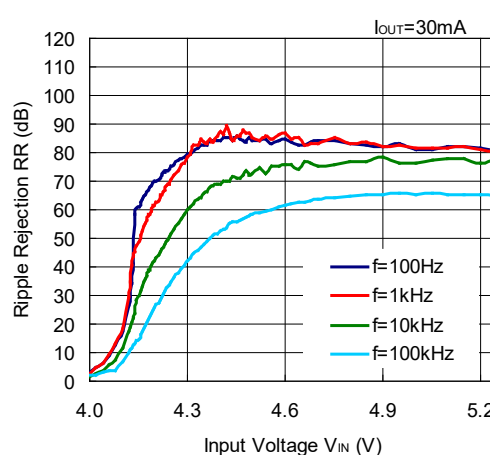

10) Ripple Rejection vs. Output Current (C1 = none, C2 = Ceramic 1.0 μ F, Ripple = 0.2 Vp-p, Ta = 25°C)

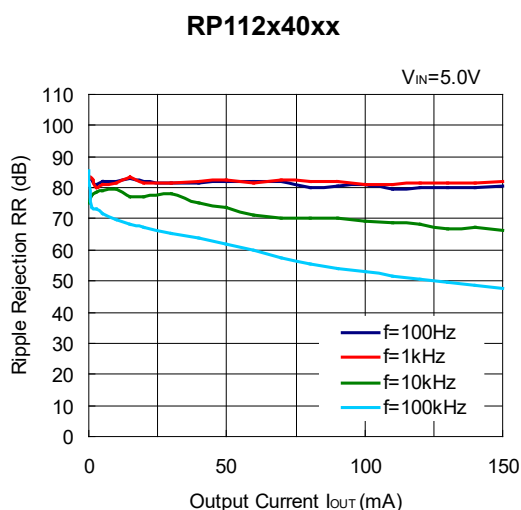
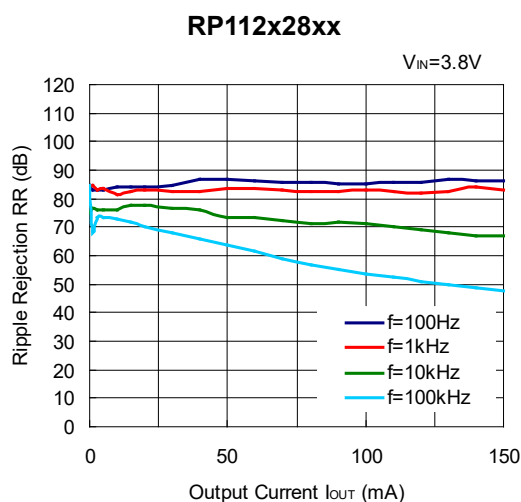
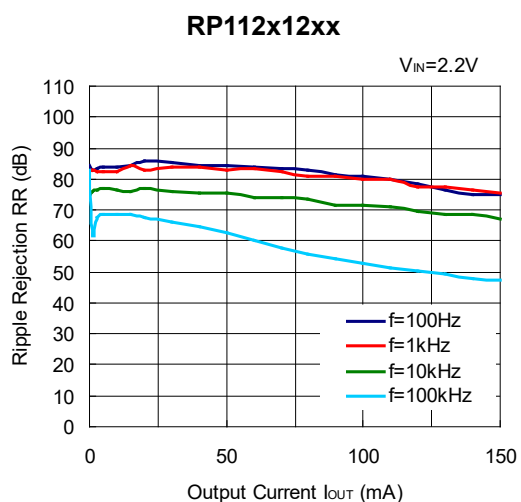

11) Ripple Rejection vs. Frequency (C1 = none, C2 = Ceramic 1.0 μ F, Ripple = 0.2 Vp-p, Ta = 25°C)

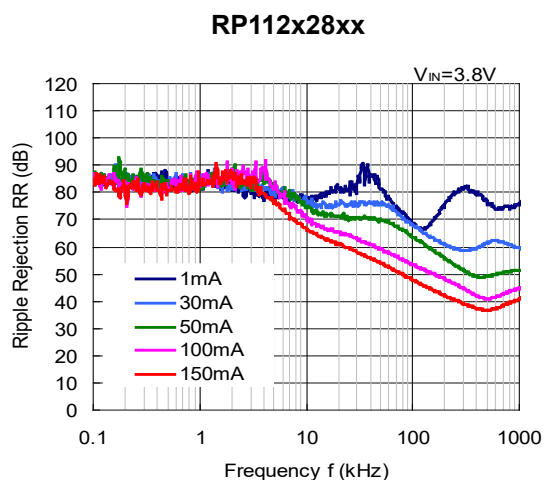
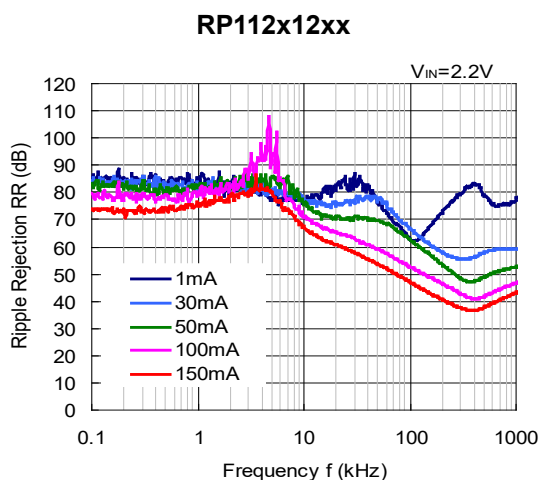

RP112x40xx

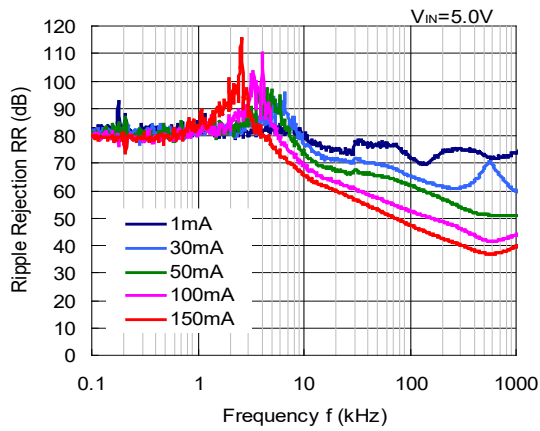

12) Output Spectral Noise Density vs. Frequency (C1 = none, C2 = Ceramic 1.0 μ F, Ta = 25°C)

RP112x12xx

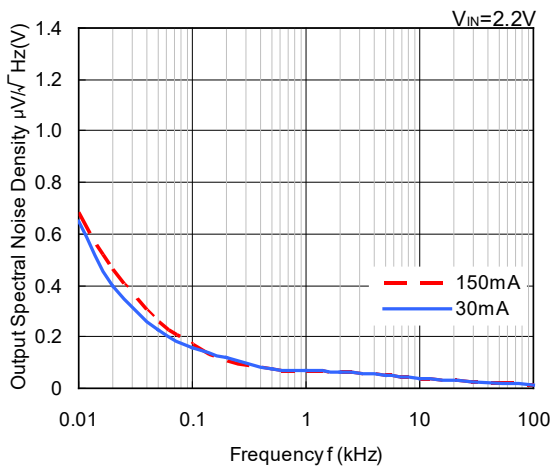

RP112x28xx

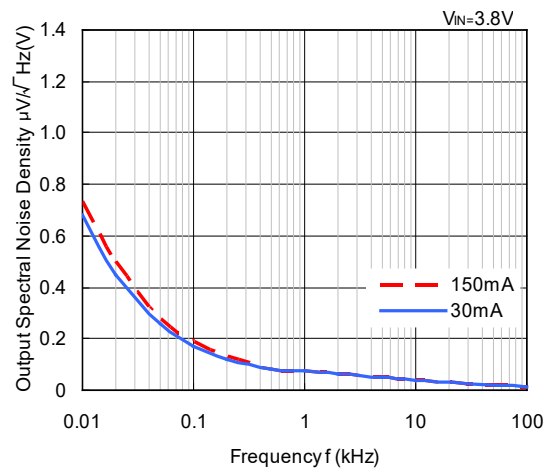

RP112x40xx

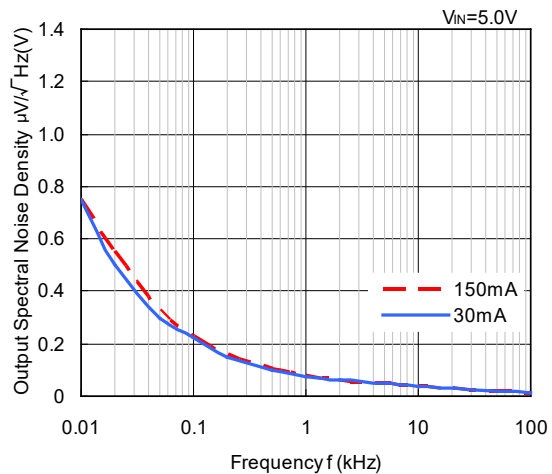

RP112x48xx

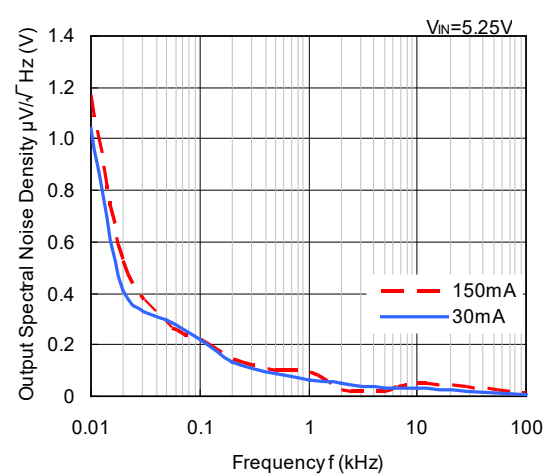

13) Input Transient Response (C1 = none, C2 = Ceramic 1.0 μ F, I_{OUT} = 30mA, tr = tf = 5.0 μ s, Ta = 25°C)

RP112x12xx

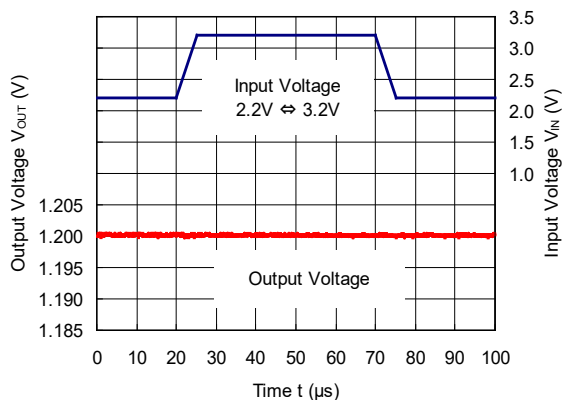

RP112x28xx

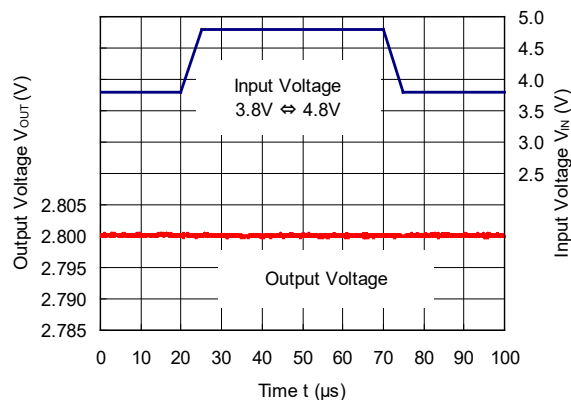

RP112x40xx

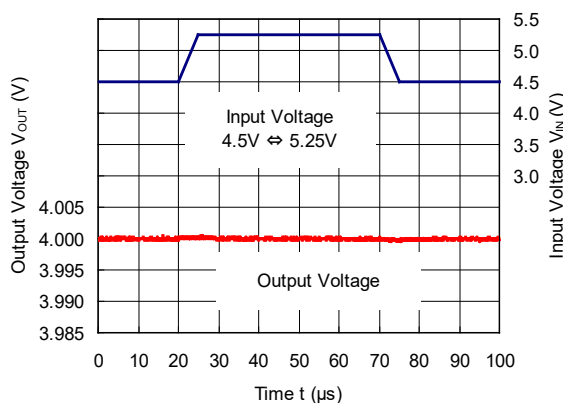

RP112x48xx

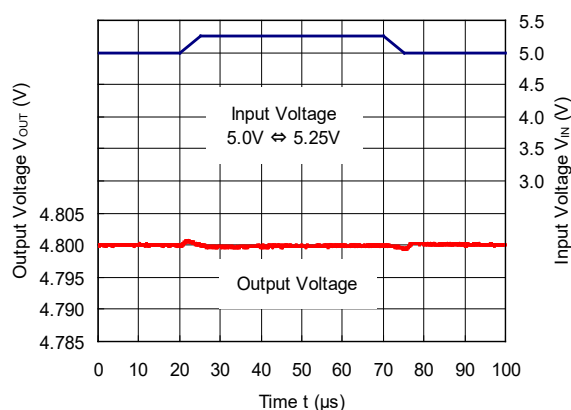

14) Load Transient Response (C1 = Ceramic 1.0 μ F, C2 = Ceramic 1.0 μ F, tr = tf = 0.5 μ s, Ta = 25°C)

RP112x12xx

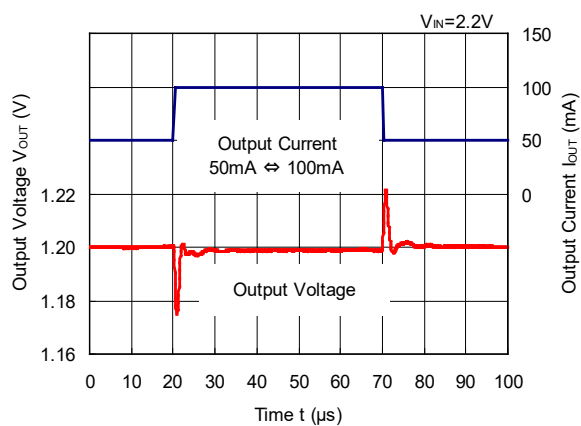

RP112x12xx

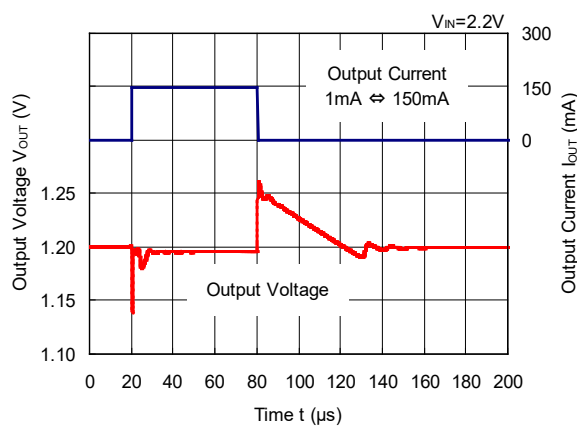

RP112x28xx

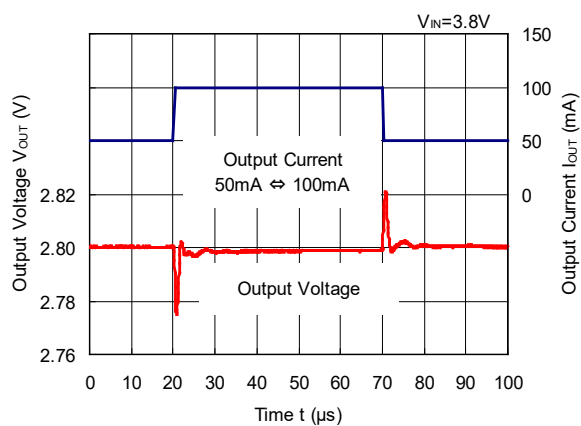

RP112x28xx

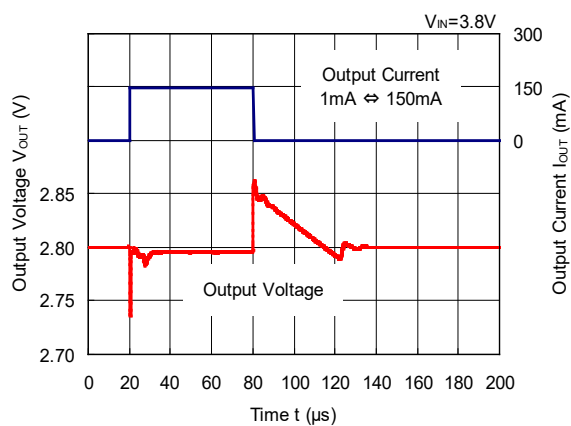

RP112x40xx

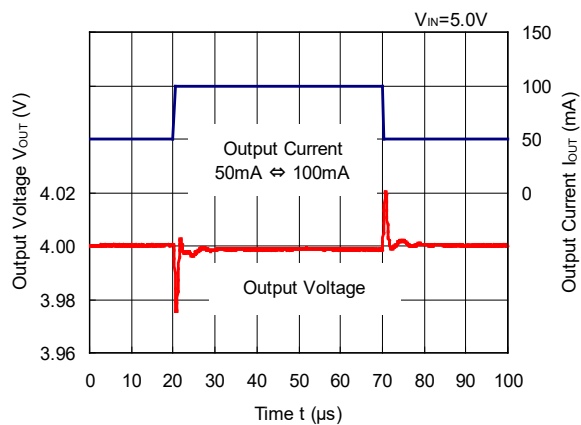

RP112x40xx

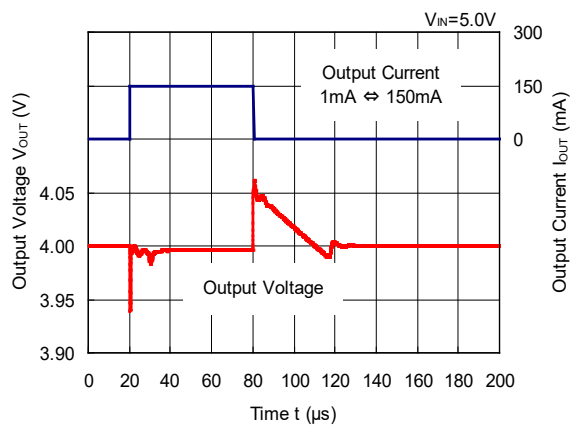

RP112x48xx

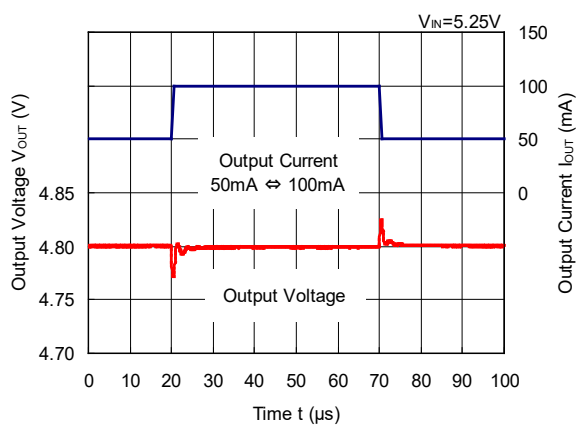

RP112x48xx

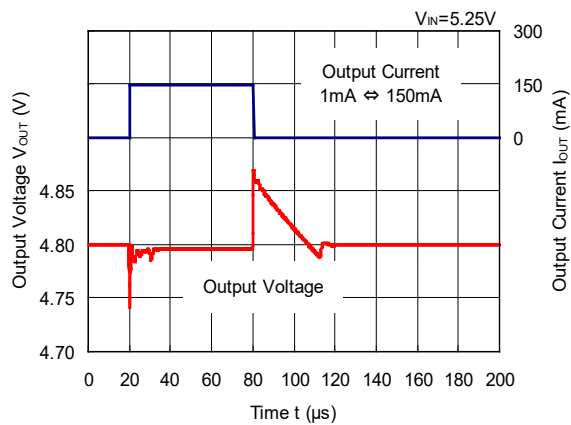

15) Turn on Speed with CE pin (C1 = Ceramic 1.0 μ F, C2 = Ceramic 1.0 μ F, Ta = 25°C)

RP112x12xx

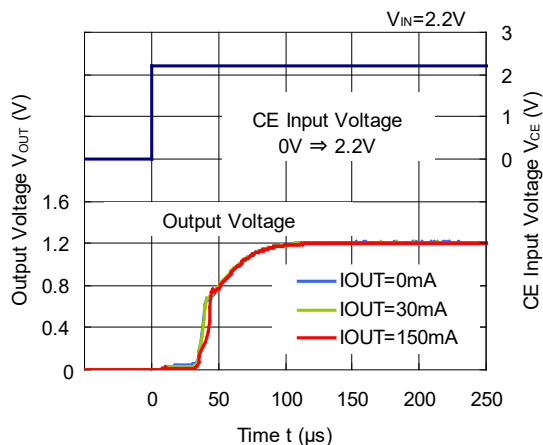

RP112x28xx

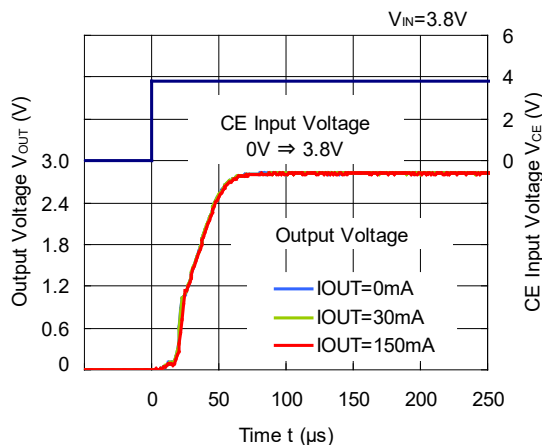

RP112x40xx

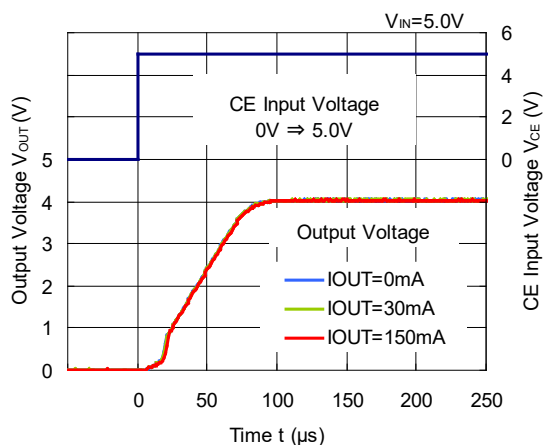

RP112x48xx

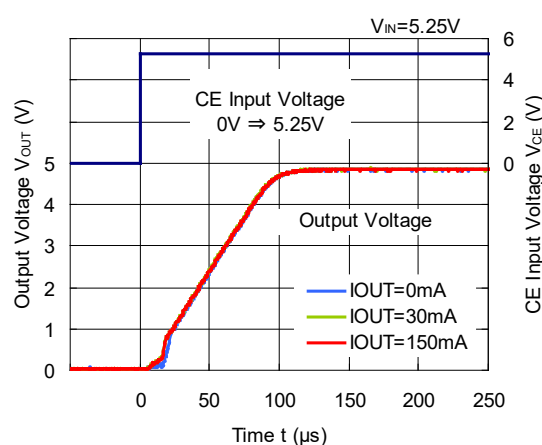

16) Turn off Speed with CE pin (RP112xxxxB) (C1 = Ceramic 1.0 μ F, C2 = Ceramic 1.0 μ F, Ta = 25°C)

RP112x12xx

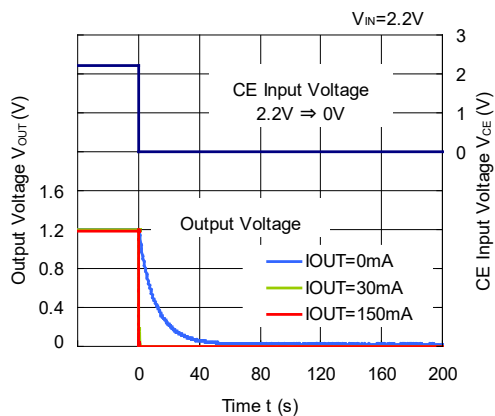

RP112x28xx

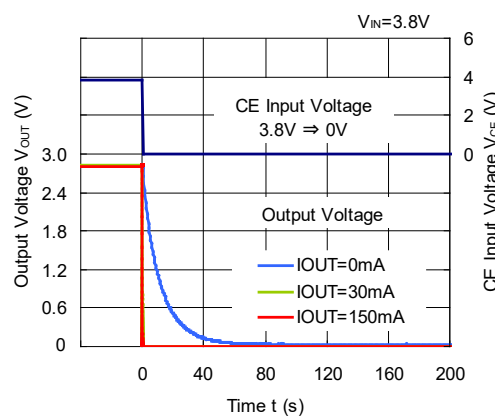

RP112x40xB

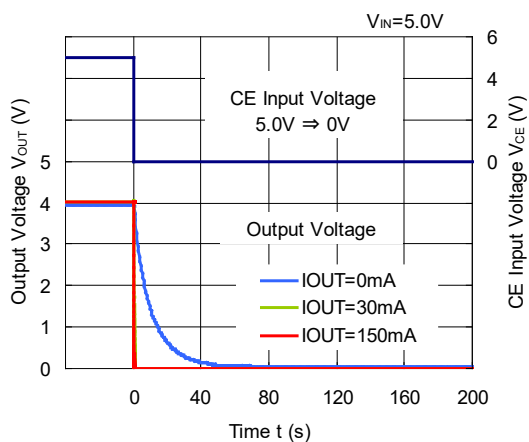

17) Turn off Speed with CE pin (RP112xxxxD) (C1 = Ceramic 1.0 μF , C2 = Ceramic 1.0 μF , Ta = 25°C)

RP112x12xD

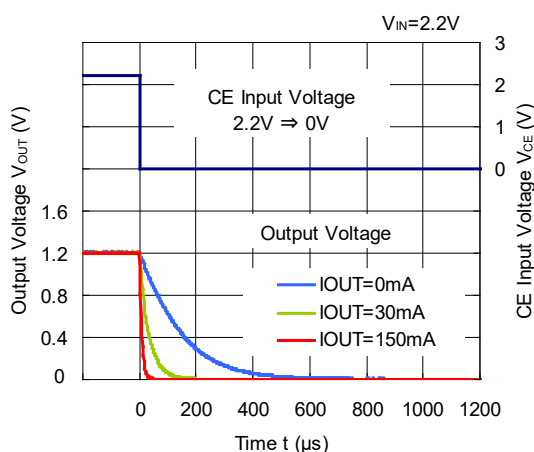

RP112x28xD

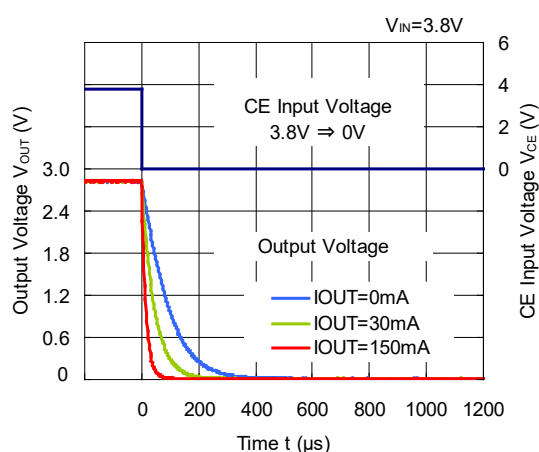

RP112x40xD

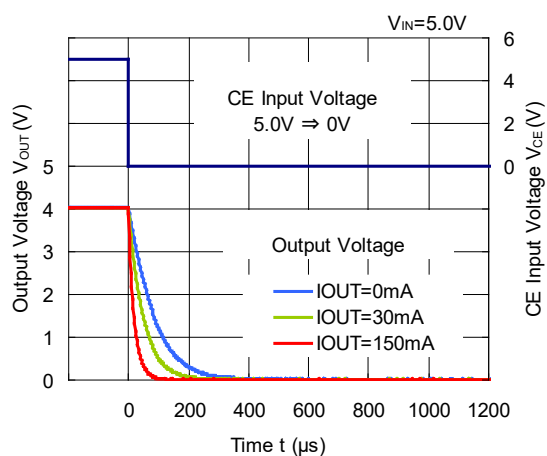

18) Inrush Current (C1 = Ceramic 1.0 μ F, I_{OUT} = 0 mA, Ta = 25°C)

RP112x12xx

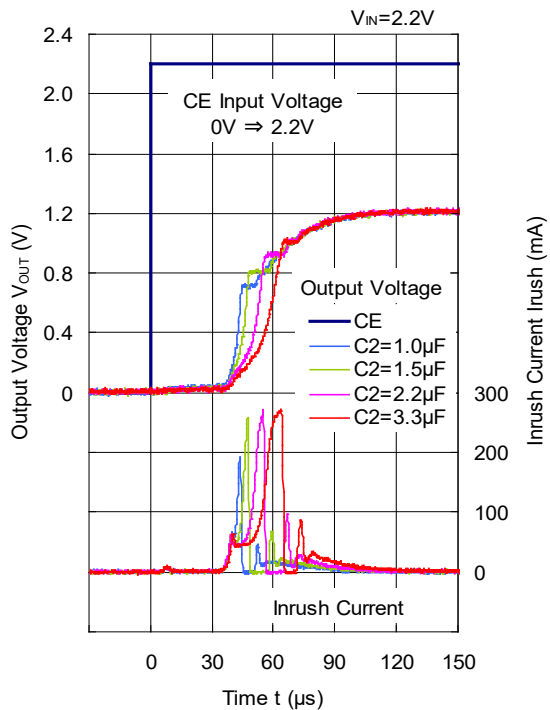

RP112x28xx

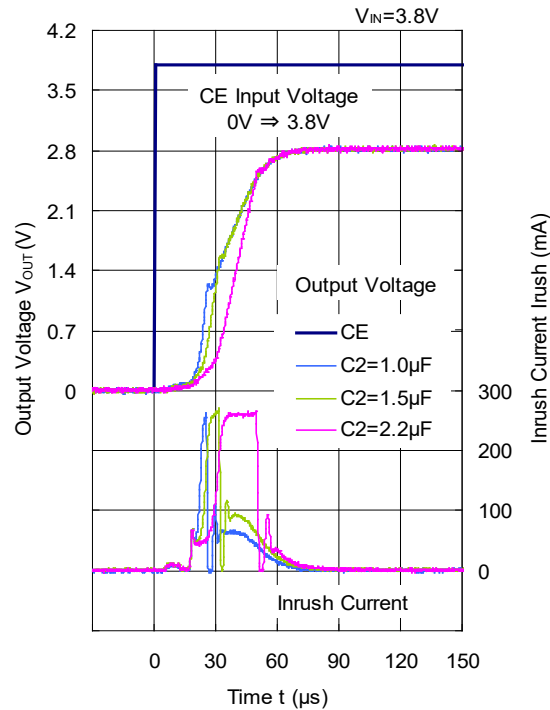

RP112x40xx

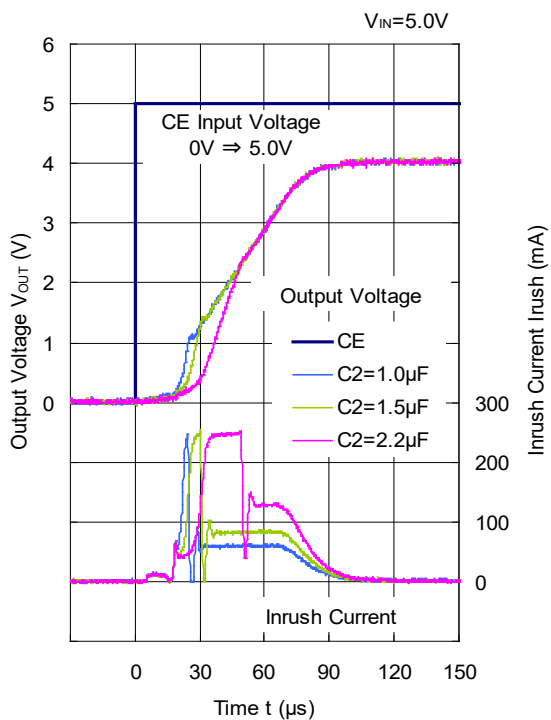

RP112x48xx

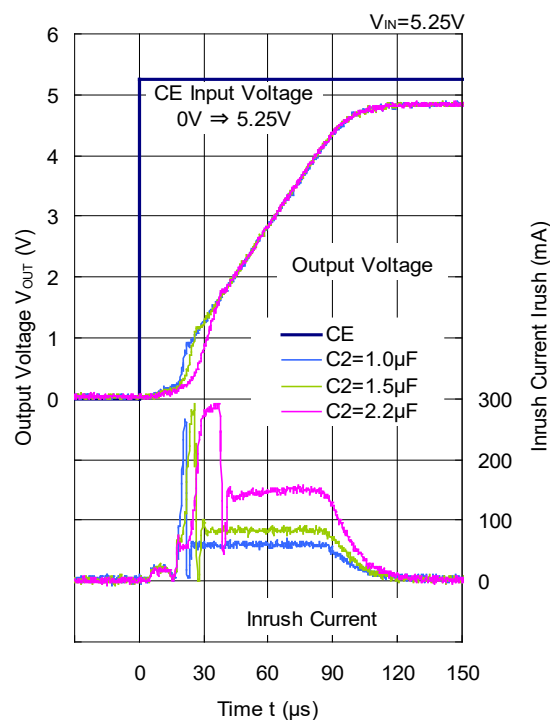

Equivalent Series Resistance vs. Output Current

When using these ICs, consider the following points:

The relations between I_{OUT} (Output Current) and ESR of an output capacitor are shown below.

The conditions when the white noise level is under $40 \mu\text{V}$ (Avg.) are marked as the hatched area in the graph.

Measurement Conditions

Frequency Band: 10 Hz to 2 MHz

Temperature: -40°C to 85°C

Hatched Area: Noise level is under $40 \mu\text{V}$ (Avg.)

C1, C2: $1.0 \mu\text{F}$ or more

RP112x12xx

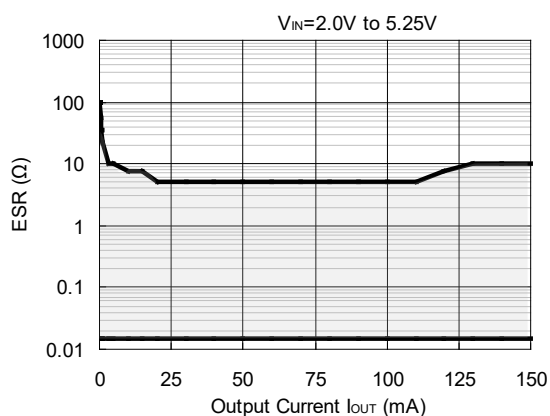

RP112x28xx

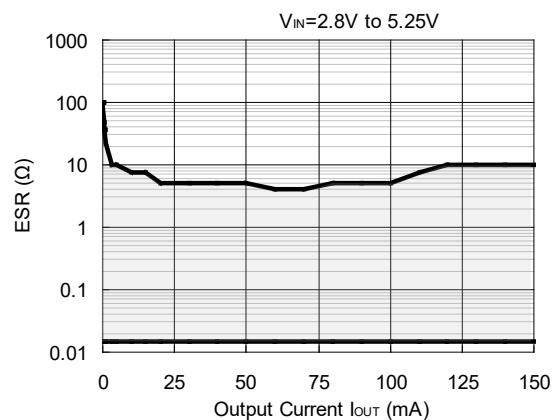

RP112x40xx

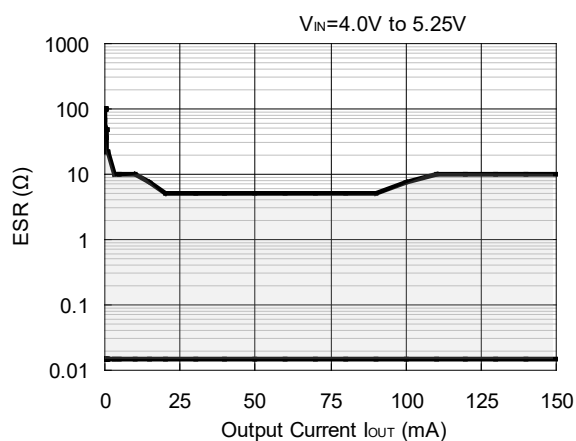

The power dissipation of the package is dependent on PCB material, layout, and environmental conditions. The following measurement conditions are based on JEDEC STD. 51-7.

Measurement Conditions

Item	Measurement Conditions
Environment	Mounting on Board (Wind Velocity = 0 m/s)
Board Material	Glass Cloth Epoxy Plastic (Four-Layer Board)
Board Dimensions	76.2 mm × 114.3 mm × 0.8 mm
Copper Ratio	Outer Layer (First Layer): Less than 95% of 50 mm Square Inner Layers (Second and Third Layers): Approx. 100% of 50 mm Square Outer Layer (Fourth Layer): Approx. 100% of 50 mm Square
Through-holes	φ 0.2 mm × 11 pcs

Measurement Result

(Ta = 25°C, Tjmax = 125°C)

Item	Measurement Result
Power Dissipation	800 mW
Thermal Resistance (θ_{ja})	$\theta_{ja} = 125^{\circ}\text{C/W}$
Thermal Characterization Parameter (ψ_{jt})	$\psi_{jt} = 58^{\circ}\text{C/W}$

θ_{ja} : Junction-to-Ambient Thermal Resistance

ψ_{jt} : Junction-to-Top Thermal Characterization Parameter

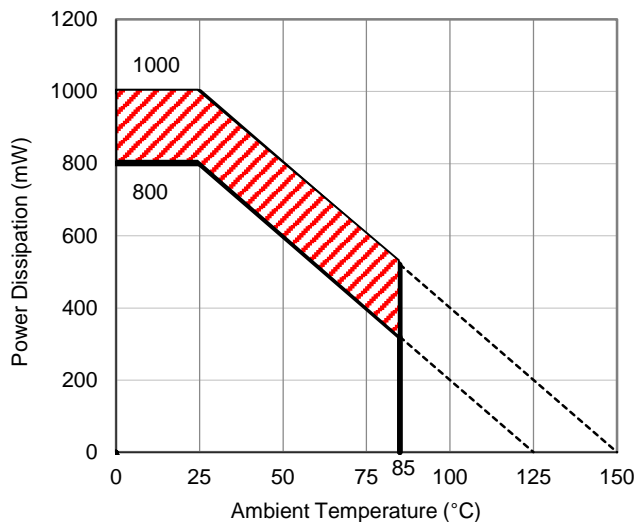

Power Dissipation vs. Ambient Temperature

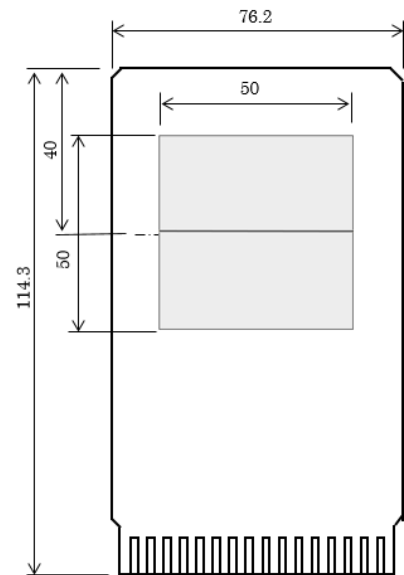

Measurement Board Pattern

The above graph shows the power dissipation of the package at $T_{jmax} = 125^{\circ}\text{C}$ and $T_{jmax} = 150^{\circ}\text{C}$. Operating the device in the hatched range might have a negative influence on its lifetime. The total hours of use and the total years of use must be limited as follows:

Total Hours of Use	Total Years of Use (4 hours/day)
13,000 hours	9 years

The power dissipation of the package is dependent on PCB material, layout, and environmental conditions. The following conditions are used in this measurement.

Measurement Conditions

Item	Standard Test Land Pattern
Environment	Mounting on Board (Wind Velocity = 0 m/s)
Board Material	Glass Cloth Epoxy Plastic (Double-Sided Board)
Board Dimensions	40 mm × 40 mm × 1.6 mm
Copper Ratio	Top Side: Approx. 50% Bottom Side: Approx. 50%
Through-holes	φ 0.5 mm × 44 pcs

Measurement Result

(Ta = 25°C, Tjmax = 125°C)

Item	Standard Test Land Pattern
Power Dissipation	380 mW
Thermal Resistance (θja)	θja = 263°C/W
Thermal Characterization Parameter (ψjt)	ψjt = 75°C/W

θja: Junction-to-Ambient Thermal Resistance

ψjt: Junction-to-Top Thermal Characterization Parameter

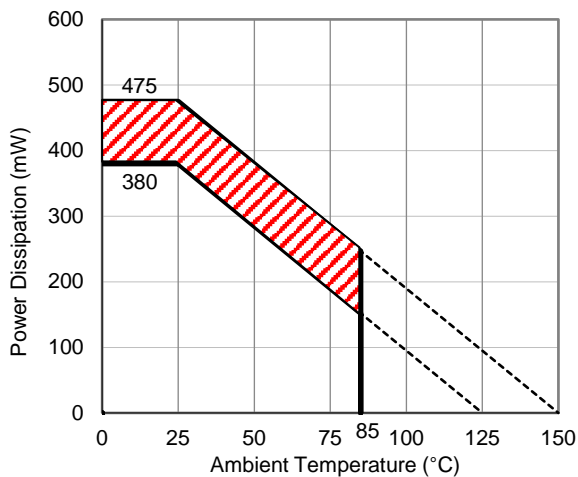

Power Dissipation vs. Ambient Temperature

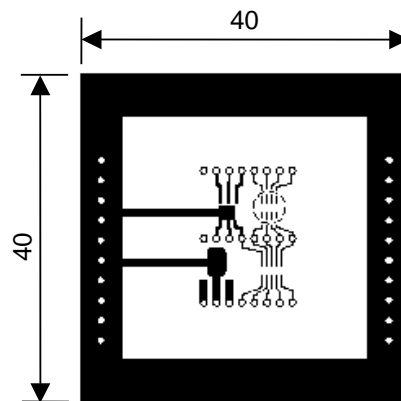

Measurement Board Pattern

The above graph shows the power dissipation of the package at Tjmax = 125°C and Tjmax = 150°C. Operating the device in the hatched range might have a negative influence on its lifetime. The total hours of use and the total years of use must be limited as follows:

Total Hours of Use	Total Years of Use (4 hours/day)
13,000 hours	9 years

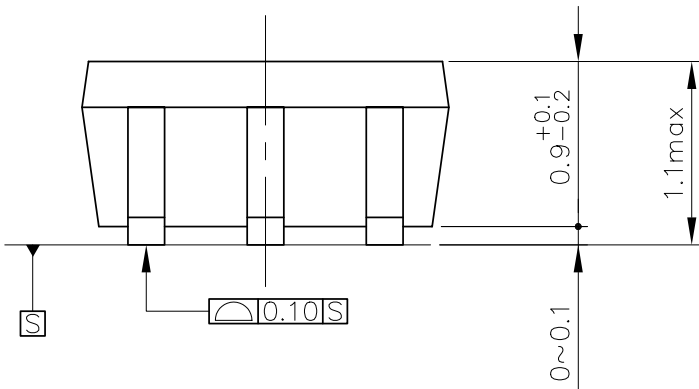
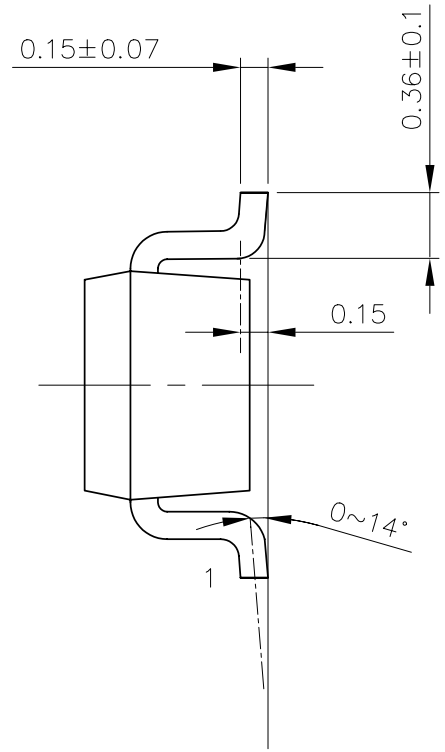
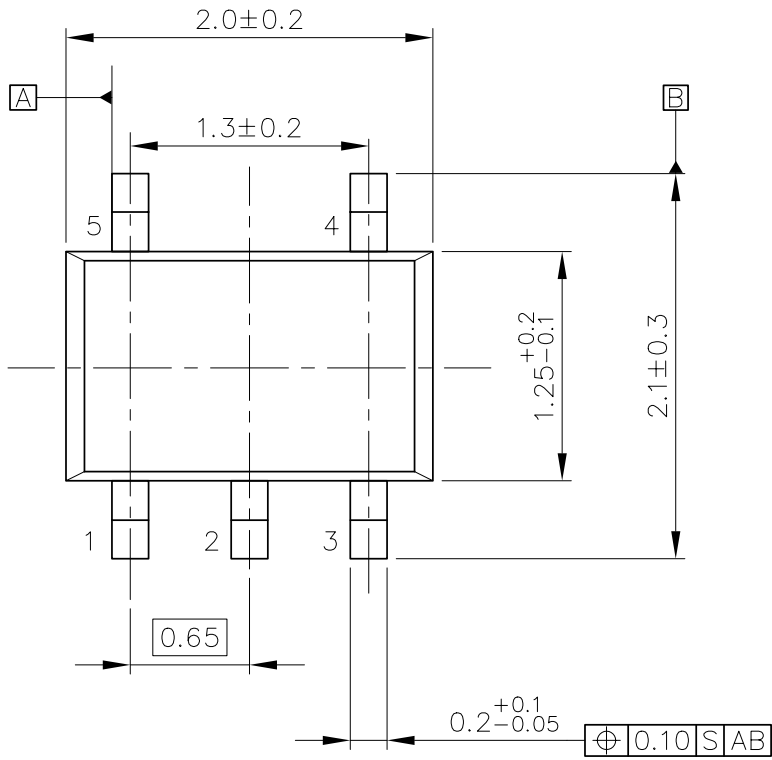

UNIT: mm

SC-88A Package Dimensions

The power dissipation of the package is dependent on PCB material, layout, and environmental conditions. The following measurement conditions are based on JEDEC STD. 51-7.

Measurement Conditions

Item	Measurement Conditions
Environment	Mounting on Board (Wind Velocity = 0 m/s)
Board Material	Glass Cloth Epoxy Plastic (Four-Layer Board)
Board Dimensions	76.2 mm × 114.3 mm × 0.8 mm
Copper Ratio	Outer Layer (First Layer): Less than 95% of 50 mm Square Inner Layers (Second and Third Layers): Approx. 100% of 50 mm Square Outer Layer (Fourth Layer): Approx. 100% of 50 mm Square
Through-holes	φ 0.3 mm × 7 pcs

Measurement Result

(Ta = 25°C, Tjmax = 125°C)

Item	Measurement Result
Power Dissipation	660 mW
Thermal Resistance (θja)	θja = 150°C/W
Thermal Characterization Parameter (ψjt)	ψjt = 51°C/W

θja: Junction-to-Ambient Thermal Resistance

ψjt: Junction-to-Top Thermal Characterization Parameter

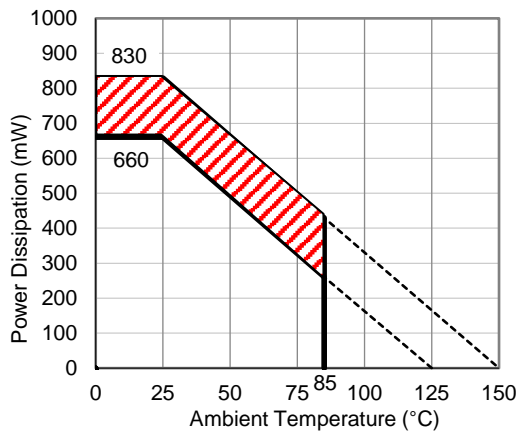

Power Dissipation vs. Ambient Temperature

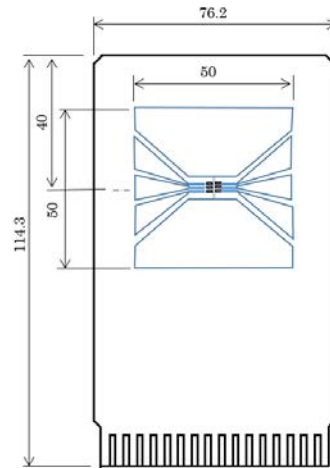

Measurement Board Pattern

The above graph shows the power dissipation of the package at Tjmax = 125°C and Tjmax = 150°C. Operating the device in the hatched range might have a negative influence on its lifetime. The total hours of use and the total years of use must be limited as follows:

Total Hours of Use	Total Years of Use (4 hours/day)
13,000 hours	9 years

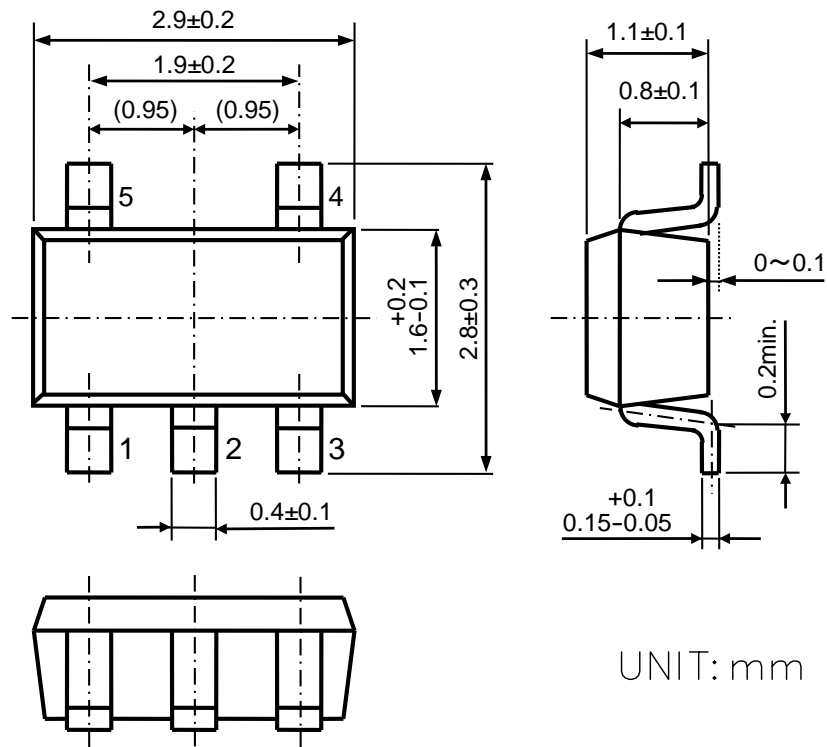

UNIT: mm

SOT-23-5 Package Dimensions

1. The products and the product specifications described in this document are subject to change or discontinuation of production without notice for reasons such as improvement. Therefore, before deciding to use the products, please refer to our sales representatives for the latest information thereon.
2. The materials in this document may not be copied or otherwise reproduced in whole or in part without the prior written consent of us.
3. This product and any technical information relating thereto are subject to complementary export controls (so-called KNOW controls) under the Foreign Exchange and Foreign Trade Law, and related politics ministerial ordinance of the law. (Note that the complementary export controls are inapplicable to any application-specific products, except rockets and pilotless aircraft, that are insusceptible to design or program changes.) Accordingly, when exporting or carrying abroad this product, follow the Foreign Exchange and Foreign Trade Control Law and its related regulations with respect to the complementary export controls.
4. The technical information described in this document shows typical characteristics and example application circuits for the products. The release of such information is not to be construed as a warranty of or a grant of license under our or any third party's intellectual property rights or any other rights.
5. The products listed in this document are intended and designed for use as general electronic components in standard applications (office equipment, telecommunication equipment, measuring instruments, consumer electronic products, amusement equipment etc.). Those customers intending to use a product in an application requiring extreme quality and reliability, for example, in a highly specific application where the failure or misoperation of the product could result in human injury or death should first contact us.
 - Aerospace Equipment
 - Equipment Used in the Deep Sea
 - Power Generator Control Equipment (nuclear, steam, hydraulic, etc.)
 - Life Maintenance Medical Equipment
 - Fire Alarms / Intruder Detectors
 - Vehicle Control Equipment (automotive, airplane, railroad, ship, etc.)
 - Various Safety Devices
 - Traffic control system
 - Combustion equipment

In case your company desires to use this product for any applications other than general electronic equipment mentioned above, make sure to contact our company in advance. Note that the important requirements mentioned in this section are not applicable to cases where operation requirements such as application conditions are confirmed by our company in writing after consultation with your company.

6. We are making our continuous effort to improve the quality and reliability of our products, but semiconductor products are likely to fail with certain probability. In order to prevent any injury to persons or damages to property resulting from such failure, customers should be careful enough to incorporate safety measures in their design, such as redundancy feature, fire containment feature and fail-safe feature. We do not assume any liability or responsibility for any loss or damage arising from misuse or inappropriate use of the products.
7. The products have been designed and tested to function within controlled environmental conditions. Do not use products under conditions that deviate from methods or applications specified in this datasheet. Failure to employ the products in the proper applications can lead to deterioration, destruction or failure of the products. We shall not be responsible for any bodily injury, fires or accident, property damage or any consequential damages resulting from misuse or misapplication of the products.
8. **Quality Warranty**
 - 8-1. **Quality Warranty Period**

In the case of a product purchased through an authorized distributor or directly from us, the warranty period for this product shall be one (1) year after delivery to your company. For defective products that occurred during this period, we will take the quality warranty measures described in section 8-2. However, if there is an agreement on the warranty period in the basic transaction agreement, quality assurance agreement, delivery specifications, etc., it shall be followed.
 - 8-2. **Quality Warranty Remedies**

When it has been proved defective due to manufacturing factors as a result of defect analysis by us, we will either deliver a substitute for the defective product or refund the purchase price of the defective product.

Note that such delivery or refund is sole and exclusive remedies to your company for the defective product.
 - 8-3. **Remedies after Quality Warranty Period**

With respect to any defect of this product found after the quality warranty period, the defect will be analyzed by us. On the basis of the defect analysis results, the scope and amounts of damage shall be determined by mutual agreement of both parties. Then we will deal with upper limit in Section 8-2. This provision is not intended to limit any legal rights of your company.
9. Anti-radiation design is not implemented in the products described in this document.
10. The X-ray exposure can influence functions and characteristics of the products. Confirm the product functions and characteristics in the evaluation stage.
11. WLCSP products should be used in light shielded environments. The light exposure can influence functions and characteristics of the products under operation or storage.
12. Warning for handling Gallium and Arsenic (GaAs) products (Applying to GaAs MMIC, Photo Reflector). These products use Gallium (Ga) and Arsenic (As) which are specified as poisonous chemicals by law. For the prevention of a hazard, do not burn, destroy, or process chemically to make them as gas or power. When the product is disposed of, please follow the related regulation and do not mix this with general industrial waste or household waste.
13. Please contact our sales representatives should you have any questions or comments concerning the products or the technical information.



Nisshinbo Micro Devices Inc.

Official website

<https://www.nisshinbo-microdevices.co.jp/en/>

Purchase information

<https://www.nisshinbo-microdevices.co.jp/en/buy/>