

Features

- UL F class rated standard
- Small size and light weight, low coil power consumption
- Heavy contact load, strong shock and vibration resistance
- UL/CUL, TÜV certified



Contact Data*

UL Contact Rating	N.O.	5A @ 280VAC Ballast 5A @ 280VAC General Purpose 20A @ 240VAC Resistive, 250k cycles, 40C 25A @ 277VAC, Resistive 100k cycles, 40C 40A @ 240VAC Resistive, 40C 30A @ 277VAC General Purpose 2hp @ 250VAC, 40C; 1hp @ 125VAC, 50K cycles, 40C
	N.C.	5A @ 280VAC Ballast 5A @ 280VAC General Purpose 30A @ 240VAC Resistive, 40C 30A @ 30VDC, 40C 20A @ 277VAC General Purpose 1-1/2hp @ 250VAC; 1/4hp @ 125VAC 50K cycles, 40C

TÜV Contact Rating	N.O.	40A @ 240VAC; 14VDC 30A @ 277VAC
	N.C.	30A @ 240VAC; 14VDC 20A @ 277VAC

Contact Arrangement	1A = SPST N.O. 1B = SPST N.C. 1C = SPDT
Contact Resistance	< 30 milliohms initial
Contact Material	AgSnO ₂ AgSnO ₂ In ₂ O ₃
Maximum Switching Power	9600VA, 1120 W
Maximum Switching Voltage	277VAC, 110VDC
Maximum Switching Current	40A

Coil Data DC Parameters*

Coil Voltage VDC		Coil Resistance Ω +/- 10%		Pick Up Voltage VDC (max)	Release Voltage VDC (min)	Coil Power W	Operate Time ms	Release Time ms
Rated	Max	.6W	.9W	75% of rated voltage	10% of rated voltage			
5	6.5	42	28	3.75	0.5	.60 .90	15	10
9	11.7	135	90	6.75	0.9			
12	15.6	240	160	9.00	1.2			
24	31.2	960	640	18.00	2.4			
48	62.4	3840	2560	36.00	4.8			
110	140.3	20167	13445	82.50	11.0			

Coil Data AC Parameters*

Coil Voltage VAC		Coil Resistance Ω +/- 10%	Pick Up Voltage VAC (max)	Release Voltage VAC (min)	Coil Power VA	Operate Time ms	Release Time ms
Rated	Max		75% of rated voltage	30% of rated voltage			
12	15.6	27 120 2360 3040 13490 15320 20210	9.0	3.6	2VA	15	10
24	31.2		18.0	7.2			
110	143		82.5	33.0			
120	156		90.0	36.0			
220	286		165.0	66.0			
240	312		180.0	72.0			
277	360		207.0	83.1			

General Data*

Electrical Life @ rated load	100K cycles, average
Mechanical Life	10M cycles, average
Insulation Resistance	1000M Ω min. @ 500VDC initial
Dielectric Strength	Coil to Contact
	Contact to Contact
	4000V rms min. @ sea level initial (H = high dielectric strength option)
	2500V rms min. @ sea level initial (with Pin 6 removed)
	1500V rms min. @ sea level initial
Shock Resistance	200m/s ² for 11 ms
Vibration Resistance	1.50mm double amplitude 10~40Hz
Terminal (Copper Alloy) Strength	10N
Operating Temperature	-55°C to +125°C
Storage Temperature	-55°C to +155°C
Solderability	260°C for 5 s
Weight	30g, 27g (no cover)

* Values can change due to the switching frequency, desired reliability levels, environmental conditions and in-rush load levels. It is recommended to test actual load conditions for the application. It is the user's responsibility to determine the performance suitability for their specific application. The use of any coil voltage less than the rated coil voltage may compromise the operation of the relay.

Ordering Information

1. Series	J115F1	1C	12VDC	S	6	.6
J115F1						
2. Contact Arrangement	1A = SPST N.O. 1B = SPST N.C. 1C = SPDT					
3. Coil Voltage	5VDC 12VAC 9VDC 24VAC 12VDC 110VAC 24VDC 120VAC 48VDC 220VAC 110VDC 240VAC 277VAC					
4. Sealing Options	S = Sealed (standard) N = No cover					
5. Option	None = Pin 6 included **not available with AC coils 6 = Pin 6 removed H = Pin 6 removed & high dielectric strength resistant **not available with AC coils					
6. Coil Power	.9 = .9W .6 = .6W Blank = 2VA (AC Coil)					
7. Contact Material	Blank = AgSnO ₂ U = AgSnO ₂ In ₂ O ₃					

Dimensions

Units = mm

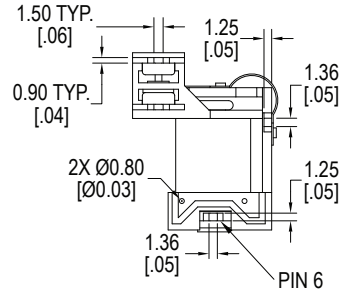
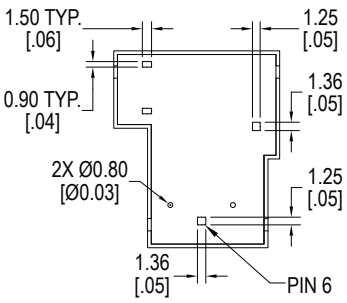
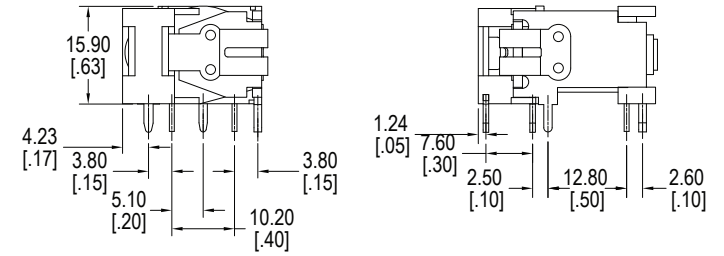
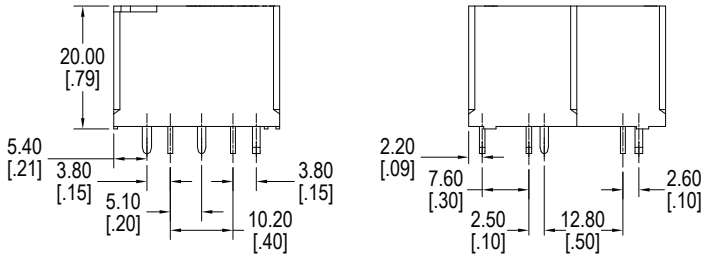
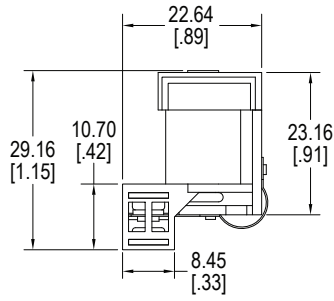
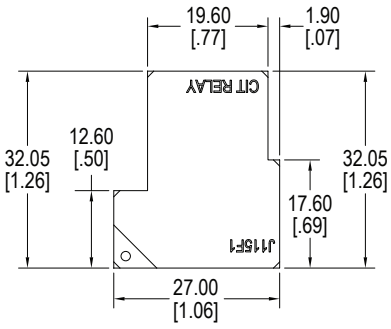

S - Sealed

N - No Cover



Schematics & PC Layouts

Bottom Views

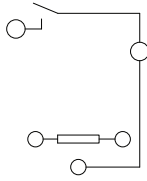

1A

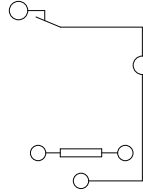

1B

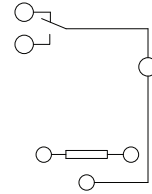

1C

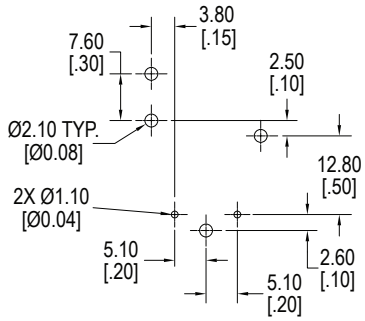

With Pin 6

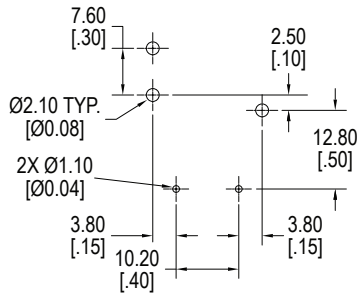

Without Pin 6