

HLMP-EGxx, HLMP-EHxx, HLMP-ELxx

New T-1^{3/4} (5mm) Extra High Brightness AllnGaP LED Lamps

Description

These precision optical performance AllnGaP LEDs provide superior light output for excellent readability in sunlight and are extremely reliable. AllnGaP LED technology provides extremely stable light output over long periods of time. Precision optical performance lamps use the aluminum indium gallium phosphide (AllnGaP) technology.

These LED lamps are untinted, T-1^{3/4} packages incorporating second generation optics producing well-defined spatial radiation patterns at specific viewing cone angles.

These lamps are made with an advanced optical grade epoxy offering superior high temperature and high moisture resistance performance in outdoor signal and sign applications. The maximum LED junction temperature limit of +130°C enables high temperature operation in bright sunlight conditions. The epoxy contains both uv-a and uv-b inhibitors to reduce the effects of long term exposure to direct sunlight.

Benefits

- Superior performance for outdoor environments
- Suitable for auto-insertion onto PC board

Features

- Viewing angle: 15°, 23°, 30°
- High luminous output
- Colors:
 - 590-nm Amber
 - 615-nm Red Orange
 - 626-nm Red
- Package options:
 - With or without lead standoff
- Superior resistance to moisture
- Untinted for 15°, 23° and 30° lamps

Applications

- Traffic management:
 - Traffic signals
 - Pedestrian signals
 - Work zone warning lights
 - Variable message signs
- Solar power signs
- Commercial outdoor advertising
 - Signs
 - Marquees

Figure 1: Package Dimensions (Package Drawing A on the Left and Package Drawing B on the Right)

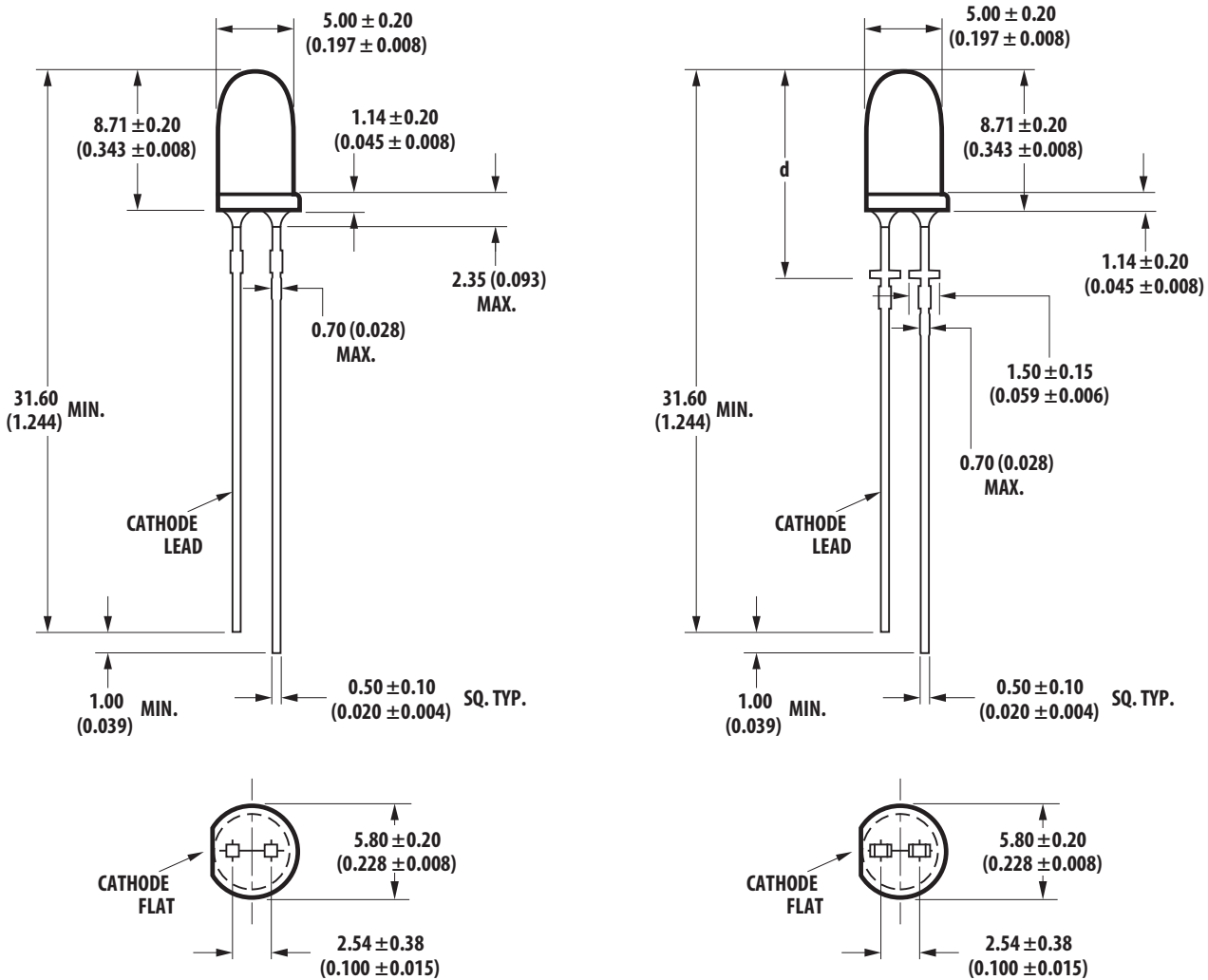

Viewing Angle	d
15°	12.39 mm ± 0.25 mm (0.476 in. ± 0.010 in.)
23° and 30°	11.96 mm ± 0.25 mm (0.459 in. ± 0.010 in.)

NOTE:

1. All dimensions are in millimeters (inches).
2. Leads are mild steel with tin plating.
3. The epoxy meniscus is 1.21 mm maximum.
4. For identification of polarity after the leads are trimmed off, see the following figure.

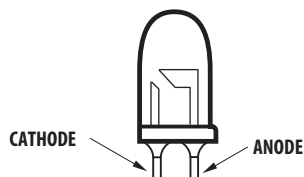

Device Selection Guide

Typical Viewing Angle $2\theta_{1/2}$ (Deg) ^a	Color and Dominant Wavelength (nm), Typ. ^b	Lamps without Standoff on Leads (Package Drawing A)	Lamps with Standoff on Leads (Package Drawing B)	Luminous Intensity I_v (mcd) ^{c, d, e} at 20 mA	
				Min.	Max.
15°	Amber 590	HLMP-EL1A-Z1Kxx	HLMP-EL1B-Z1Kxx	12000	21000
		HLMP-EL1A-Z1LDD	HLMP-EL1B-Z1LDD	12000	21000
	Red 626	HLMP-EG1A-Z10xx	HLMP-EG1B-Z10DD	12000	21000
	Red Orange 615	HLMP-EH1A-120DD	HLMP-EH1B-120DD	16000	27000
23°	Amber 590	HLMP-EL2A-YZKDD	HLMP-EL2B-YZKDD	9300	16000
		HLMP-EL2A-YZLDD	HLMP-EL2B-YZLDD	9300	16000
	Red 626	HLMP-EG2A-XY0xx	HLMP-EG2B-XY0xx	7200	12000
	Red Orange 615	HLMP-EH2A-Y10DD	HLMP-EH2B-Y10DD	9300	21000
30°	Amber 590	HLMP-EL3A-WXKxx	HLMP-EL3B-WXKxx	5500	9300
		HLMP-EL3A-WXLDD	HLMP-EL3B-WXLDD	5500	9300
	Red 626	HLMP-EG3A-WX0xx	HLMP-EG3B-WX0xx	5500	9300
	Red Orange 615	HLMP-EH3A-WX0xx	HLMP-EH3B-WX0DD	5500	9300

- $\theta_{1/2}$ is the off-axis angle where the luminous intensity is half the on-axis intensity.
- Dominant wavelength, λ_d , is derived from the CIE Chromaticity Diagram and represents the color of the lamp.
- The luminous intensity is measured on the mechanical axis of the lamp package and it is tested with pulsing condition.
- The optical axis is closely aligned with the package mechanical axis.
- Tolerance for each bin limit is $\pm 15\%$.

Absolute Maximum Ratings

$T_J = 25^\circ\text{C}$.

Parameter	Red/Amber/ RedOrange	Units
DC Forward Current ^a	50	mA
Peak Forward Current	100 ^b	mA
Average forward current	30	mA
Power Dissipation	120	mW
Reverse Voltage	5	V
Operating Temperature Range	-40 to +100	°C
Storage Temperature Range	-40 to +100	°C

- Derate linearly as shown in [Figure 6](#).
- Duty factor 30%, frequency 1 KHz.

Electrical/Optical Characteristics

$T_J = 25^\circ\text{C}$.

Parameter	Symbol	Min.	Typ.	Max.	Units	Test Conditions
Forward Voltage Amber/ Red/Red Orange	V_F	1.8	2.1	2.4	V	$I_F = 20\text{ mA}$
Reverse Voltage	V_R	5	—	—	V	$I_R = 100\ \mu\text{A}$
Dominant Wavelength ^a Amber Red Red Orange	λ_d	584.5 618.0 612.0	590.0 626.0 615.0	594.5 630.0 619.0	nm	$I_F = 20\text{ mA}$
Peak Wavelength Amber Red Red Orange	λ_{PEAK}	— — —	594 634 621	— — —	nm	Peak of Wavelength of Spectral Distribution at $I_F = 20\text{ mA}$
Spectral Halfwidth Amber Red Red Orange	$\Delta\lambda_{1/2}$	— — —	13 14 14	— — —	nm	
Thermal Resistance	$R\theta_{J-PIN}$	—	240	—	$^\circ\text{C/W}$	LED junction to anode lead
Luminous Efficacy ^b Amber Red Red Orange	η_v	— — —	500 200 265	— — —	lm/W	Emitted Luminous Flux/Emitted Radiant Flux
Luminous Flux Amber Red Red Orange	ϕ_v	— — —	2100 2300 2300	— — —	mlm	$I_F = 20\text{ mA}$
Luminous Efficiency ^c Amber Red Red Orange	η_e	— — —	50 55 55	— — —	lm/W	Emitted Luminous Flux/Electrical Power
Thermal Coefficient of λ_d Amber Red Red Orange		— — —	0.08 0.05 0.07	— — —	nm/ $^\circ\text{C}$	$I_F = 20\text{ mA}$; $+25^\circ\text{C} \leq T_J \leq +100^\circ\text{C}$

a. The dominant wavelength, λ_d is derived from the CIE Chromaticity Diagram referenced to Illuminant E. Tolerance for each color of dominant wavelength is $\pm 0.5\text{ nm}$.

b. The radiant intensity, I_e in watts per steradian, maybe found from the equation $I_e = I_v / \eta_v$ where I_v is the luminous intensity in candela and η_v is the luminous efficacy in lumens/ watt.

c. $\eta_e = \phi_v / I_F \times V_F$ where ϕ_v is the emitted luminous flux, I_F is electrical forward current and V_F is the forward voltage.

Part Numbering System

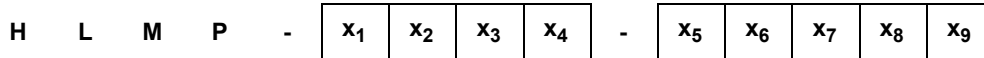

Code	Description	Option	
x ₁	Package type	E	5-mm Standard Round AlInGaP
x ₂	Color	G	Red
		L	Amber
		H	Red Orange
x ₃ x ₄	Viewing angle and lead standoffs	1A	15° without lead standoffs
		1B	15° with lead standoffs
		2A	23° without lead standoffs
		2B	23° with lead standoffs
		3A	30° without lead standoffs
		3B	30° with lead standoffs
x ₅	Minimum intensity bin	Refer to Device Selection Guide	
x ₆	Maximum intensity bin		
x ₇	Color bin selection	0	Full range
		K	Color bin 2 and 4
		L	Color bin 4 and 6
x ₈ x ₉	Packaging option	00	Bulk packaging
		DD	Ammopack

Bin Information

Intensity Bin Limit Table (1.3:1 Iv Bin Ratio)

Bin	Intensity (mcd) at 20mA	
	Min.	Max.
V	4200	5500
W	5500	7200
X	7200	9300
Y	9300	12000
Z	12000	16000
1	16000	21000
2	21000	27000

Tolerance for each bin limit is ± 15%

V_F Bin Table (V at 20 mA)

Bin ID	Min	Max
VD	1.8	2.0
VA	2.0	2.2
VB	2.2	2.4

Tolerance for each bin limit is ± 0.05V.

Red Color Range

Min. Dom.	Max. Dom.	X Min.	Y Min.	X Max.	Y Max.
618	630	0.6872	0.3126	0.6890	0.2943
		0.6690	0.3149	0.7080	0.2920

Tolerance for each bin limit is ± 0.5 nm.

Red Orange Color Range

Min.Dom	Max. Dom	X Min.	Y Min.	X Max.	Y Max.
612	619	0.6712	0.6887	0.6716	0.6549
		0.3280	0.3109	0.3116	0.3282

Tolerance for each bin limit is ± 0.5 nm.

Amber Color Range

Bin	Min. Dom.	Max. Dom.	X Min.	Y Min.	X Max.	Y Max.
2	587	589.5	0.5570	0.4420	0.5670	0.4250
			0.5530	0.4400	0.5720	0.4270
4	589.5	592	0.5720	0.4270	0.5820	0.4110
			0.5670	0.4250	0.5870	0.4130
6	592	594.5	0.5870	0.4130	0.5950	0.3980
			0.5820	0.4110	0.6000	0.3990

Tolerance for each bin limit is ± 0.5 nm.

NOTE: All bin categories are established for classification of products. Products may not be available in all bin categories. Contact a Broadcom representative for further information.

Figure 2: Broadcom Color Bin on CIE 1931 Chromaticity Diagram

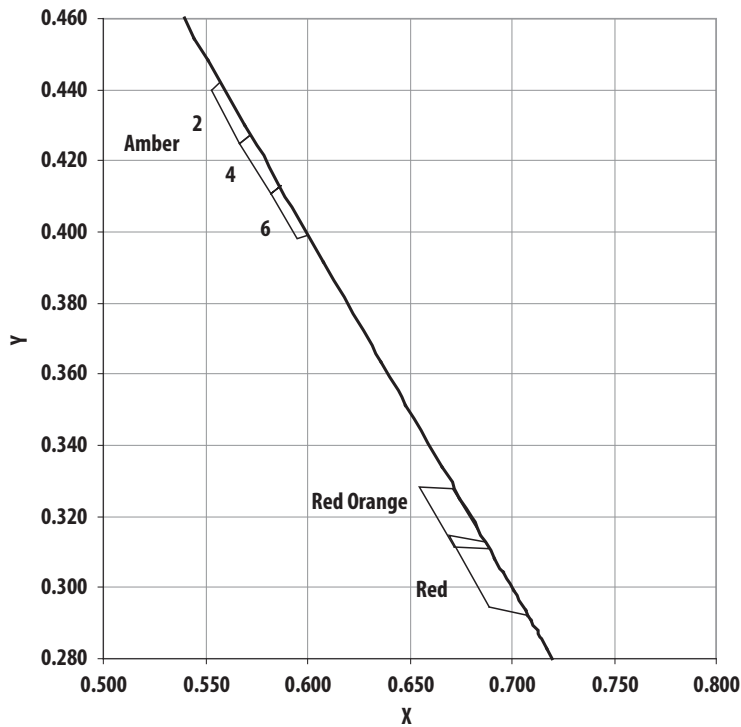

Figure 3: Relative Intensity vs. Peak Wavelength

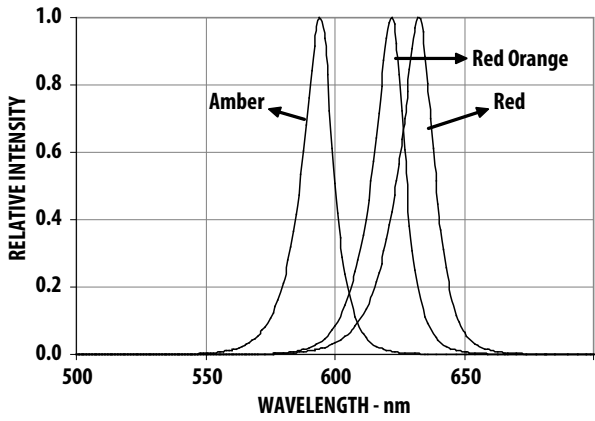

Figure 4: Forward Current vs. Forward Voltage

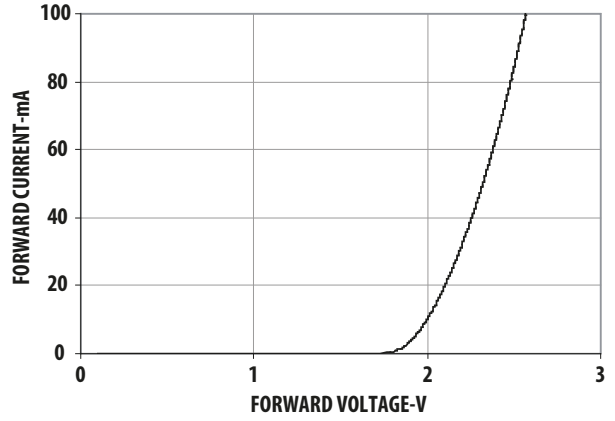

Figure 5: Relative Luminous Intensity vs. Forward Current

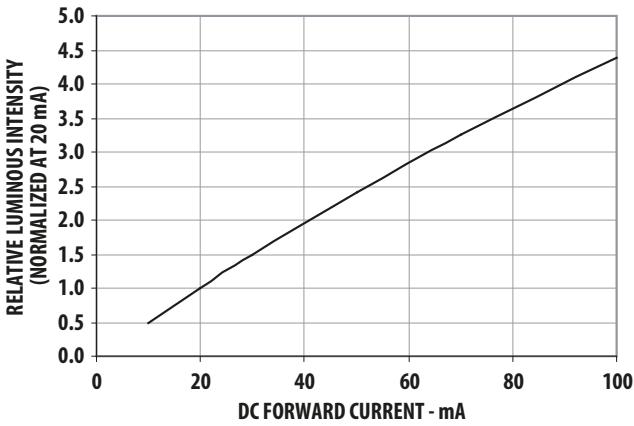

Figure 6: Maximum Forward Current vs. Ambient Temperature

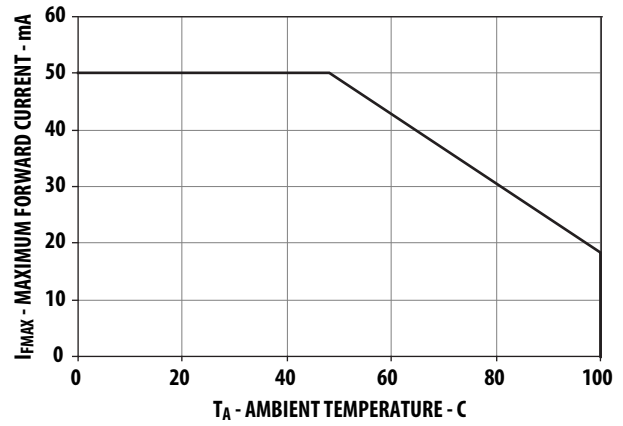

Figure 7: Radiation Pattern for 15° Viewing Angle Lamp

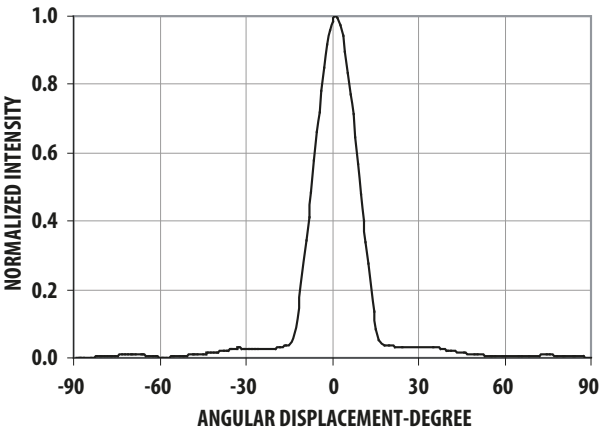

Figure 8: Radiation Pattern for 23° Viewing Angle Lamp

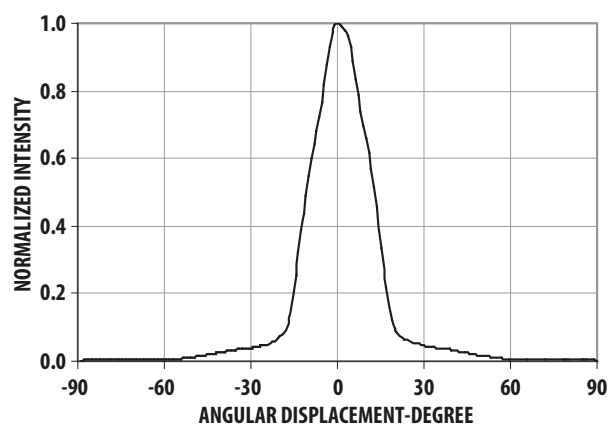

Figure 9: Radiation Pattern for 30° Viewing Angle Lamp

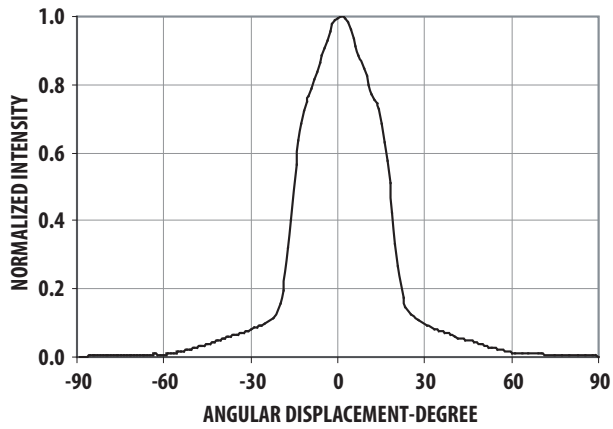

Figure 10: Relative Light Output vs. Junction Temperature

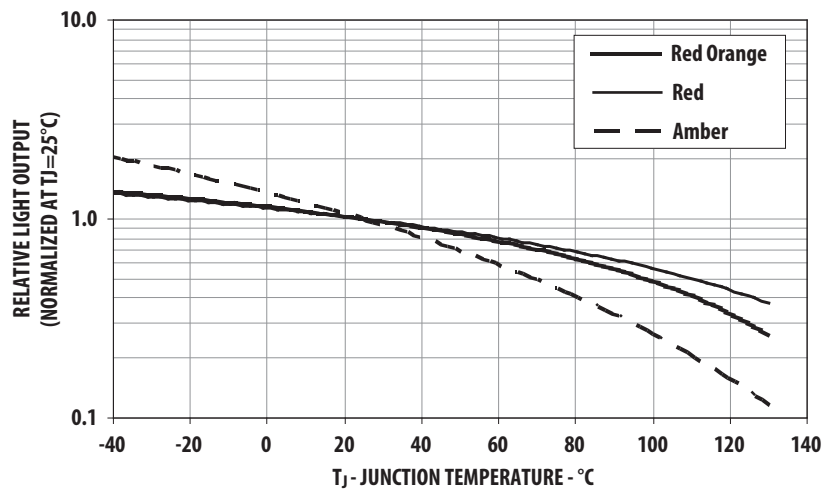
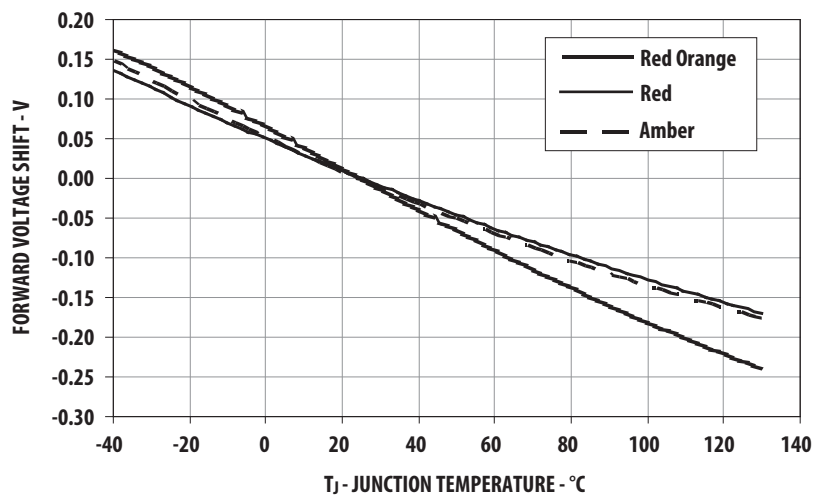

Figure 11: Relative Forward Voltage vs. Junction Temperature



Precautions

Lead Forming

- The leads of an LED lamp may be preformed or cut to length prior to insertion and soldering on the PC board.
- For better control, use the proper tool to precisely form and cut the leads to the applicable length rather than doing it manually.
- If manual lead cutting is necessary, cut the leads after the soldering process. The solder connection forms a mechanical ground that prevents mechanical stress due to lead cutting from traveling into LED package. Use this method for hand soldering operations, because the excess lead length also acts as a small heat sink.

Soldering and Handling

- Take care during PCB assembly and soldering process to prevent damage to the LED component.
- The LED component may be effectively hand soldered to PCB; however, use this method only under unavoidable circumstances, such as rework. The closest manual soldering distance of the soldering heat source (the soldering iron’s tip) to the body is 1.59 mm. Soldering the LED using the soldering iron tip closer than 1.59 mm might damage the LED.

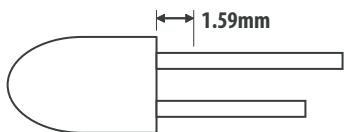

- Apply ESD precautions on the soldering station and personnel to prevent ESD damage to the LED component, which is ESD sensitive. Refer to Broadcom Application Note AN-1142 for details. Use a soldering iron with a grounded tip to ensure that the electrostatic charge is properly grounded.

- Recommended soldering condition:

	Wave Soldering ^{a, b}	Manual Solder Dipping
Pre-heat temperature	105°C max.	—
Preheat time	60 seconds max.	—
Peak temperature	260°C max.	260°C max.
Dwell time	5 seconds max.	5 seconds max

- The above conditions refer to a measurement with thermocouple mounted at the bottom of PCB.
- Use only bottom preheaters to reduce thermal stress experienced by the LED.

- Set and maintain wave soldering parameters according to the recommended temperature and dwell time. Perform daily checks on the soldering profile to ensure that it conforms to the recommended soldering conditions.

NOTE:

- PCBs with different sizes and designs (component density) have different heat masses (heat capacity). This might cause a change in temperature experienced by the board if the same wave soldering setting is used. Therefore, you must recalibrate the soldering profile again before loading a new type of PCB.
- Broadcom’s high brightness LEDs use high efficiency LED dies with a single wire bond as follows. Take extra precautions during wave soldering to ensure that the maximum wave temperature does not exceed 260°C and the solder contact time does not exceeding 5 seconds. Over-stressing the LED during soldering process might cause premature failure to the LED due to delamination.

Broadcom LED Configuration

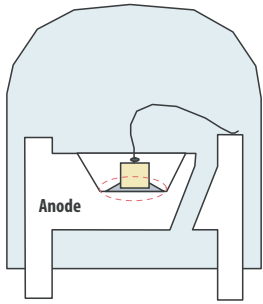

NOTE: Electrical connection between the bottom surface of the LED die and the lead frame is achieved through conductive paste.

- Any alignment fixture that is being applied during wave soldering should be loosely fitted and should not apply weight or force on the LED. Use non-metal material because it will absorb less heat during the wave soldering process.

NOTE: To help you design an accurate jig that fits the Broadcom product, a three-dimensional model of the product is available upon request.

- At elevated temperatures, LED is more susceptible to mechanical stress. Therefore, allow the PCB to cool down to room temperature prior to handling, which includes removal of the alignment fixture or pallet.
- If the PCB board contains both through-hole (TH) LEDs and other surface mount components, solder surface mount components on the top side of the PCB. If surface-mount LEDs must be soldered on the bottom side, solder these components using reflow soldering prior to insertion the TH LED.
- Recommended PC board plated through holes (PTHs) size for LED component leads follows:

LED Component Lead Size	Diagonal	Plated Through-Hole Diameter
0.45 mm × 0.45 mm (0.018 in. × 0.018 in.)	0.636 mm (0.025 in.)	0.98 mm to 1.08 mm (0.039 in. to 0.043 in.)
0.50 mm × 0.50 mm (0.020 in. × 0.020 in.)	0.707 mm (0.028 in.)	1.05 mm to 1.15 mm (0.041 in. to 0.045 in.)

- Over-sizing the PTH can lead to a twisted LED after clinching. On the other hand, under-sizing the PTH can cause difficulty inserting the TH LED.

Refer to Application Note AN5334 for more information about soldering and handling of high-brightness TH LED lamps.

Figure 12: Example of Wave Soldering Temperature Profile for TH LED

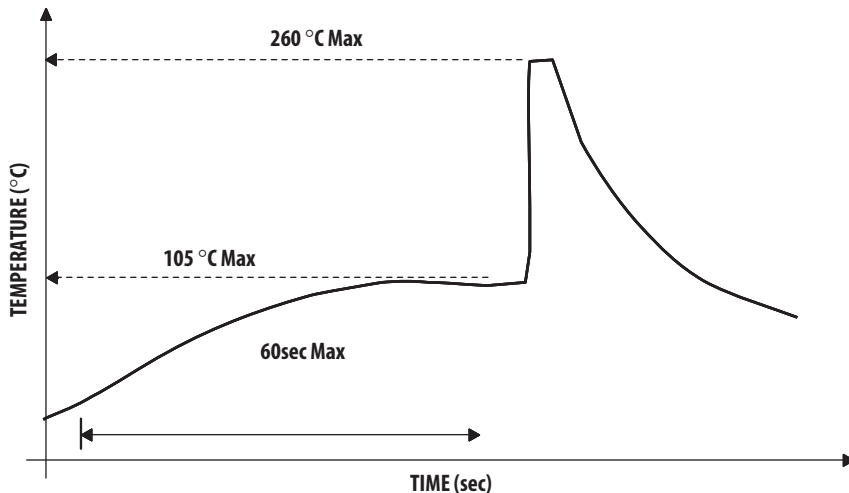

Recommended solder:
 Sn63 (Leaded solder alloy)
 SAC305 (Lead free solder alloy)

Flux: Rosin flux

Solder bath temperature: 255°C ± 5°C
 (maximum peak temperature = 260°C)

Dwell time: 3.0 sec - 5.0 sec
 (maximum = 5sec)

Note: Allow for board to be sufficiently cooled to room temperature before exerting mechanical force.

Ammo Packs Drawing

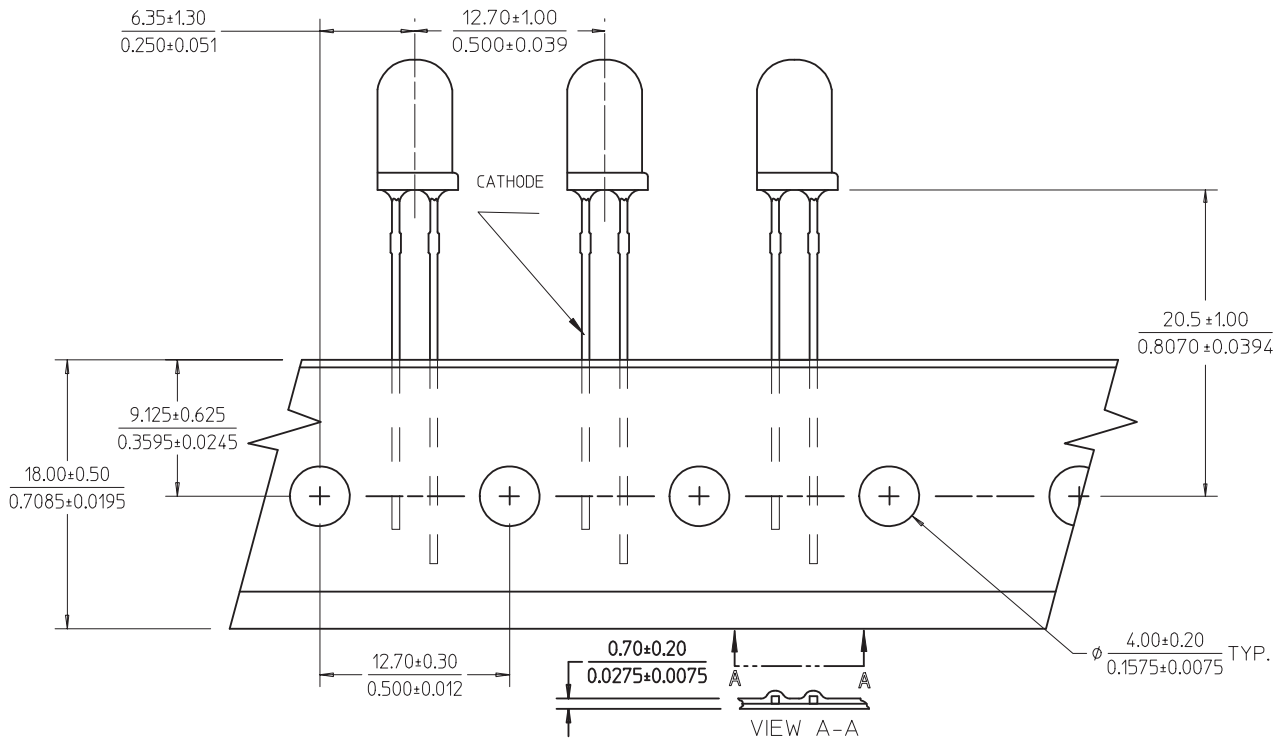

NOTE: The ammo-packs drawing is applicable for packaging option -DD and -ZZ, regardless standoff or non-standoff.



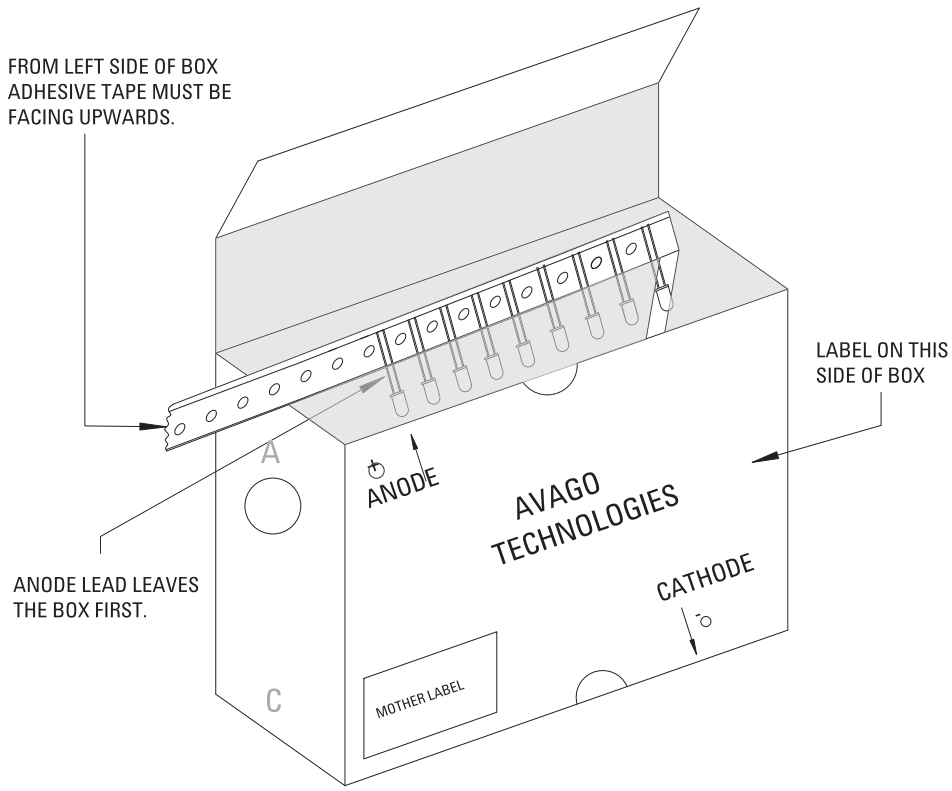





Packaging Box for Ammo Packs









NOTE: The dimension for ammo pack is applicable for the device with standoff and without standoff.

Packaging Label

Mother Label (Available on Packaging Box of Ammo Pack and Shipping Box)

	
(1P) Item: Part Number 	STANDARD LABEL LS0002 RoHS Compliant e3 max temp 260C
(1T) Lot: Lot Number 	(Q) QTY: Quantity 
LPN: 	CAT: Intensity Bin 
(9D)MFG Date: Manufacturing Date 	BIN: Refer to below information
<hr/>	
(P) Customer Item: 	
(V) Vendor ID: 	(9D) Date Code: Date Code 
<hr/>	
DeptID: 	Made In: Country of Origin 

Baby Label (Only Available on Bulk Packaging)

	
Lamps Baby Label	
RoHS Compliant e3 max temp 260C	
(1P) PART #: Part Number 	
(1T) LOT #: Lot Number 	
(9D)MFG DATE: Manufacturing Date 	QUANTITY: Packing Quantity 
<hr/>	
C/O: Country of Origin	
Customer P/N: 	CAT: Intensity Bin 
Supplier Code: 	BIN: Refer to below information 
	DATECODE: Date Code 

Acronyms and Definition

BIN:

- (i) Color bin only or V_F bin only
 (Applicable for part number with color bins but without V_F bin OR part number with V_F bins and no color bin)

OR

- (ii) Color bin incorporated with V_F Bin
 (Applicable for part number that have both color bin and V_F bin)

Example:

- (i) Color bin only or V_F bin only
 BIN: 2 (represent color bin 2 only)
 BIN: VB (represent V_F bin “VB” only)

- (ii) Color bin incorporate with V_F Bin

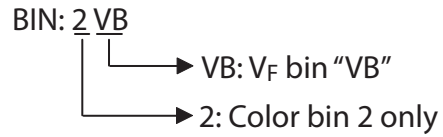

Disclaimer

Broadcom's products and software are not specifically designed, manufactured, or authorized for sale as parts, components, or assemblies for the planning, construction, maintenance, or direct operation of a nuclear facility or for use in medical devices or applications. The customer is solely responsible, and waives all rights to make claims against Broadcom or its suppliers, for all loss, damage, expense, or liability in connection with such use.

Broadcom, the pulse logo, Connecting everything, Avago Technologies, Avago, and the A logo are among the trademarks of Broadcom and/or its affiliates in the United States, certain other countries and/or the EU.

Copyright © 2014–2017 by Broadcom. All Rights Reserved.

The term "Broadcom" refers to Broadcom Limited and/or its subsidiaries. For more information, please visit www.broadcom.com.

Broadcom reserves the right to make changes without further notice to any products or data herein to improve reliability, function, or design. Information furnished by Broadcom is believed to be accurate and reliable. However, Broadcom does not assume any liability arising out of the application or use of this information, nor the application or use of any product or circuit described herein, neither does it convey any license under its patent rights nor the rights of others.

