	<b>Date</b>	<b>13-Oct-2021</b>	<b>SPECIFICATION</b>	<b>OLE WOLFF</b>
	<b>Page</b>	<b>1 / 8</b>		<b>www.owolff.com</b>
	<b>CN</b>	<b>P/N: OWMB-505020S-40-12D</b>		<b>Revision: 02</b>



## SPECIFICATION FOR APPROVAL

### SMD Electro-Magnetic Transducer

<b>Part Number</b>	<b>OWMB-505020S-40-12D</b>
<b>Note</b>	This item is in compliance with the following requirements : 1. RoHS directive 2. REACH
<b>Customer P/N</b>	

Ole Wolff	Signature / Date	Prepared	Checked	Approved

Customer	Signature / Date	Confirmation		

**REVISION NOTES:**

Date	Rev.	Description of Revision
01.03.2019	00	Initial Release
24.09.2021	01	Update drawing.
13.10.2021	02	Coding: change year and month to year and week.

OLE WOLFF ELEKTRONIK A/S Roedengvej 25 4180 Soroe Denmark  TEL: +45 57833830 FAX: +45 57820019	OLE WOLFF ELECTRONICS INC. 1525 McCarthy Blvd, Suite 1093 Milpitas, Ca 95035 USA  TEL: +1 408 888 8413	OLEWOLFF ELEKTRONIK GmbH Schulstrasse 15A. DE-25451 Quickborn. Germany  TEL: +49 (0) 4106 765900 FAX: +49 (0) 4106 627297	OLEWOLFF ELECTRONICS 3 Bedford Street, Woburn, Bedfordshire MK17 9QB, ENGLAND  TEL: +44 (0) 1525 290755 FAX: +44 (0) 1525 290855	OLE WOLFF ELEKTRONIK Yliopistonkatu 26 (P.O.BOX 257) FI-40101 Jyväskylä Finland  TEL: +358 14 338 3050 FAX: +358 14 338 3059	OLE WOLFF (ASIA) LTD. Unit B, 19/F., Bold Win Ind. Bldg., No. 16-18 Wah Sing St., Kwai Chung, N.T., H.K.  TEL: +852 2424 3274 FAX: +852 2424 2219	OLE WOLFF LTD. 5 Floor, Block G, WenTao Industrial Park, YingRenShi, Bao'an District, Shenzhen, PRC  TEL: +86 755 82612542 TEL: +86 755 26406156
---	---	--	--	--	--	---

	<b>Date</b>	<b>13-Oct-2021</b>	<b>SPECIFICATION</b>	<b>OLE WOLFF</b>
	<b>Page</b>	<b>2 / 8</b>		<b>www.owolff.com</b>
	<b>CN</b>	<b>P/N: OWMB-505020S-40-12D</b>		<b>Revision: 02</b>

## 1. SCOPE

THIS SPECIFICATION IS APPLIED TO OLE WOLFF SMD ELECTRO-MAGNETIC TRANSDUCER UNIT OF MODEL: OWMB-505020S-40-12D

## 2. GENERAL REQUIREMENTS

OPERATING TEMPERATURE RANGE: -40°C ~ +105°C

STORAGE TEMPERATURE RANGE: -40°C ~ +120°C

## 3. MECHANICAL LAYOUT & DIMENSIONS

DIMENSIONS: SHOWN IN FIGURE 3.

WEIGHT: 0.12g

## 4. ELECTRICAL CHARACTERISTICS

NO.	ITEM	SPECIFICATION
1	RATED VOLTAGE	3Vo-p
2	OPERATING VOLTAGE	2~5Vo-p
3	RESONANT FREQUENCY	4000Hz
4	COIL RESISTANCE	12 ± 2 Ω
5	*RATED CURRENT	≤100mA
6	* SOUND OUTPUT AT 10cm	≥80dB
7	HOUSING MATERIAL	LCP

\*Applying rated voltage (Resonant frequency, 1/2 duty, Square wave)

OLE WOLFF ELEKTRONIK A/S Roedengvej 25 4180 Soroe Denmark  TEL: +45 57833830 FAX: +45 57820019	OLE WOLFF ELECTRONICS INC. 1525 McCarthy Blvd, Suite 1093 Milpitas, Ca 95035 USA  TEL: +1 408 888 8413	OLEWOLFF ELEKTRONIK GmbH Schulstrasse 15A. DE-25451 Quickborn. Germany  TEL: +49 (0) 4106 765900 FAX: +49 (0) 4106 627297	OLEWOLFF ELECTRONICS 3 Bedford Street, Woburn, Bedfordshire MK17 9QB, ENGLAND  TEL: +44 (0) 1525 290755 FAX: +44 (0) 1525 290855	OLE WOLFF ELEKTRONIK Yliopistonkatu 26 (P.O.BOX 257) FI-40101 Jyväskylä Finland  TEL: +358 14 338 3050 FAX: +358 14 338 3059	OLE WOLFF (ASIA) LTD. Unit B, 19/F., Bold Win Ind. Bldg., No. 16-18 Wah Sing St., Kwai Chung, N.T., H.K.  TEL: +852 2424 3274 FAX: +852 2424 2219	OLE WOLFF LTD. 5 Floor, Block G, WenTao Industrial Park, YingRenShi, Bao'an District, Shenzhen, PRC  TEL: +86 755 82612542 TEL: +86 755 26406156
---	---	--	--	--	--	---

	<b>Date</b>	13-Oct-2021	<b>SPECIFICATION</b>	<b>OLE WOLFF</b>
	<b>Page</b>	3 / 8		<b>www.owolff.com</b>
	<b>CN</b>	<b>P/N: OWMB-505020S-40-12D</b>		<b>Revision: 02</b>

## 5. RELIABILITY TEST

<p>- <b>After Test</b> All specifications must be satisfied after the test.</p>																			
<p><b>5.1 High temperature Test</b> Temperature: +120±2°C Duration: 120HRS</p>																			
<p><b>5.2 Low temperature Test</b> Temperature: -40±2°C Duration: 120HRS</p>																			
<p><b>5.3 Humidity Test</b> Temperature: +40±2°C Humidity: 90~95%RH Duration: 120HRS</p>																			
<p><b>5.4 Temperature cycling Test</b></p> <table border="0" style="width: 100%;"> <tr> <td>Temperature:</td> <td>-40±2°C</td> <td>room temp.</td> <td>+120±2°C</td> <td>room temp.</td> </tr> <tr> <td>Duration:</td> <td>30min</td> <td>15min</td> <td>30min</td> <td>15min</td> </tr> <tr> <td>Cycle:</td> <td colspan="4">5 cycles</td> </tr> </table>					Temperature:	-40±2°C	room temp.	+120±2°C	room temp.	Duration:	30min	15min	30min	15min	Cycle:	5 cycles			
Temperature:	-40±2°C	room temp.	+120±2°C	room temp.															
Duration:	30min	15min	30min	15min															
Cycle:	5 cycles																		
<p><b>5.5 Vibration Test</b> Input power: 10Hz(a period is 1 minute) Amplitude: 1.52mm(9.3g) Duration: 2 hours per plane in each three mutually perpendicular planes for a total time of 6 hours.</p>																			
<p><b>5.6 Shock Test</b> Sounder shall be measured after being applied shock (980m/s<sup>2</sup>) for each three mutually perpendicular directions to each of 3 times by half sine wave.</p>																			
<p><b>5.7 Drop Test</b> Dropped naturally from 700mm height onto the surface of 10mm thick wooden board. 2 directions-upper and side of the part are to be applied.</p>																			
<p><b>5.8 Lead pull</b> The part shall be pulled/push with a force of 15N for 10±1 seconds behind the part.</p> <div style="text-align: center;">  </div> <p>After the test part shall meet specifications without any degradation in appearance and performance.</p>																			
<p><b>Warranty:</b>For a period of one year from date of manufacture under normal operations.</p>																			

OLE WOLFF ELEKTRONIK A/S Roedengvej 25 4180 Soroe Denmark  TEL: +45 57833830 FAX: +45 57820019	OLE WOLFF ELECTRONICS INC. 1525 McCarthy Blvd, Suite 1093 Milpitas, Ca 95035 USA  TEL : +1 408 888 8413	OLEWOLFF ELEKTRONIK GmbH Schulstrasse 15A. DE-25451 Quickborn. Germany  TEL: +49 (0) 4106 765900 FAX: +49 (0) 4106 627297	OLEWOLFF ELECTRONICS 3 Bedford Street, Woburn, Bedfordshire MK17 9QB, ENGLAND  TEL: +44 (0) 1525 290755 FAX: +44 (0) 1525 290855	OLE WOLFF ELEKTRONIK Yliopistonkatu 26 (P.O.BOX 257) FI-40101 Jyväskylä Finland  TEL: +358 14 338 3050 FAX: +358 14 338 3059	OLE WOLFF (ASIA) LTD. Unit B, 19/F., Bold Win Ind. Bldg., No. 16-18 Wah Sing St., Kwai Chung, N.T., H.K.  TEL: +852 2424 3274 FAX: +852 2424 2219	OLE WOLFF LTD. 5 Floor, Block G, WenTao Industrial Park, YingRenShi, Bao'an District, Shenzhen, PRC  TEL: +86 755 82612542 TEL: +86 755 26406156
---	--	--	--	--	--	---

	Date	13-Oct-2021	<b>SPECIFICATION</b>	OLE WOLFF
	Page	4 / 8		www.owolff.com
	CN	P/N: OWMB-505020S-40-12D		Revision: 02

## 6. TEST METHOD (Figure 1)

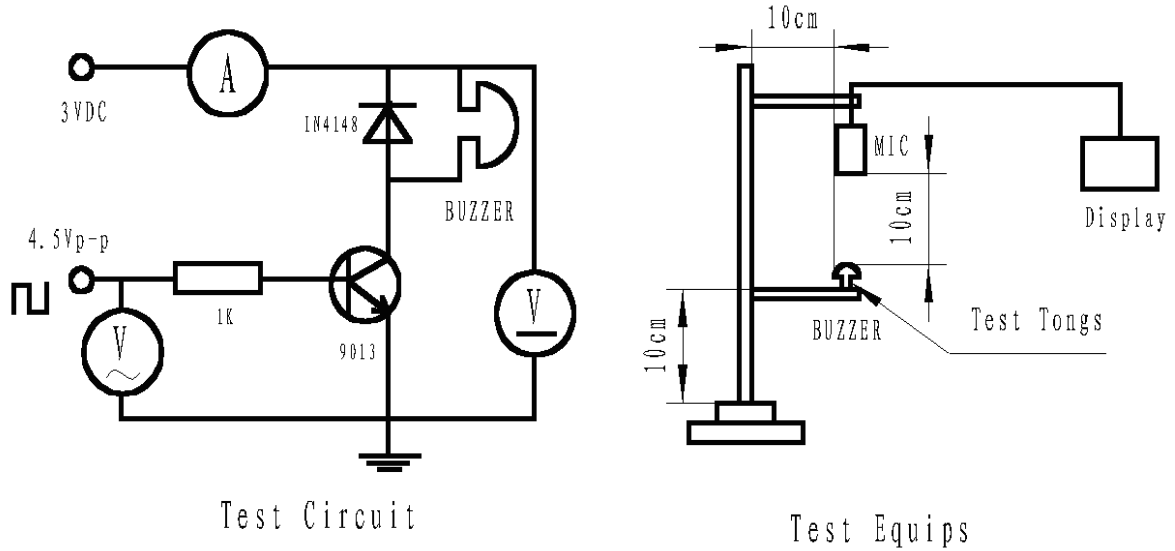

## 7. FREQUENCY RESPONSE (Figure 2)

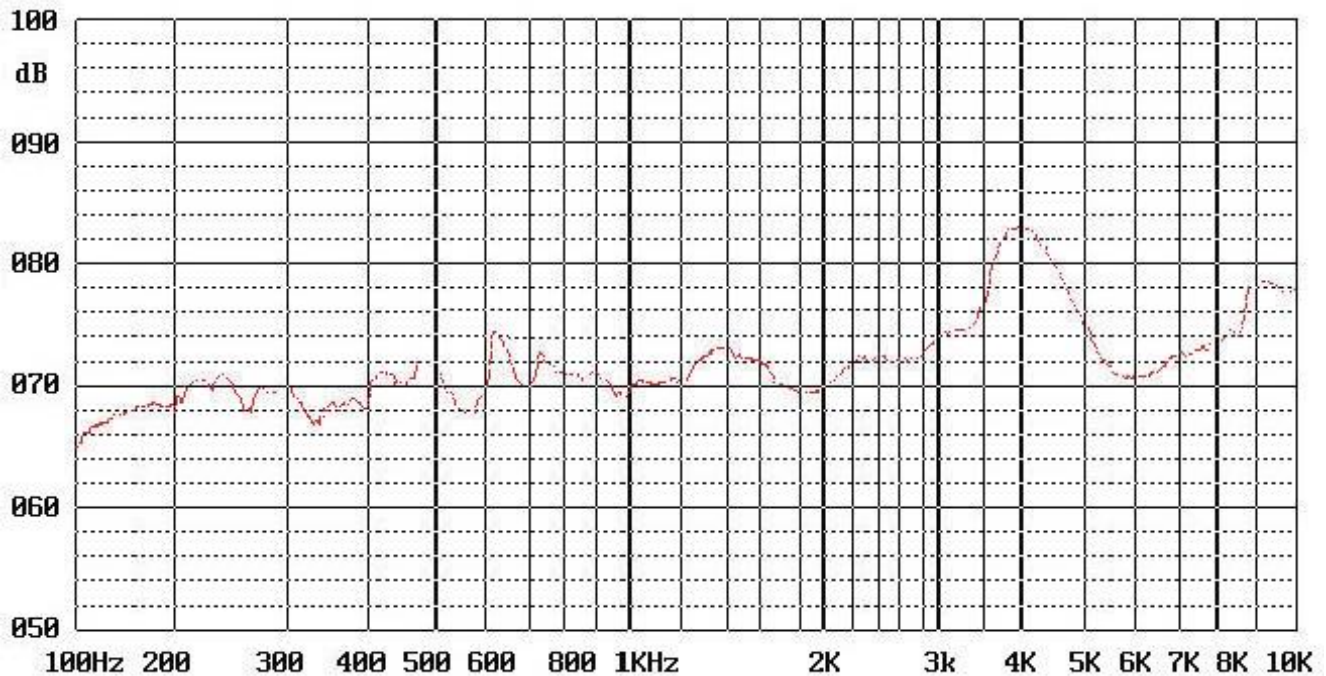

OLE WOLFF ELEKTRONIK A/S Roedengvej 25 4180 Soroe Denmark TEL: +45 57833830 FAX: +45 57820019	OLE WOLFF ELECTRONICS INC. 1525 McCarthy Blvd, Suite 1093 Milpitas, Ca 95035 USA TEL: +1 408 888 8413	OLEWOLFF ELEKTRONIK GmbH Schulstrasse 15A. DE-25451 Quickborn. Germany TEL: +49 (0) 4106 765900 FAX: +49 (0) 4106 627297	OLEWOLFF ELECTRONICS 3 Bedford Street, Woburn, Bedfordshire MK17 9QB, ENGLAND TEL: +44 (0) 1525 290755 FAX: +44 (0) 1525 290855	OLE WOLFF ELEKTRONIK Yliopistonkatu 26 (P.O.BOX 257) FI-40101 Jyväskylä Finland TEL: +358 14 338 3050 FAX: +358 14 338 3059	OLE WOLFF (ASIA) LTD. Unit B, 19/F., Bold Win Ind. Bldg., No. 16-18 Wah Sing St., Kwai Chung, N.T., H.K. TEL: +852 2424 3274 FAX: +852 2424 2219	OLE WOLFF LTD. 5 Floor, Block G, WenTao Industrial Park, YingRenShi, Bao'an District, Shenzhen, PRC TEL: +86 755 82612542 TEL: +86 755 26406156
---	---	--	--	--	--	---

	<b>Date</b>	<b>13-Oct-2021</b>	<b>SPECIFICATION</b>	<b>OLE WOLFF</b>
	<b>Page</b>	<b>5 / 8</b>		<b>www.owolff.com</b>
	<b>CN</b>	<b>P/N: OWMB-505020S-40-12D</b>		<b>Revision: 02</b>

### 8. DIMENSIONS (Figure 3)

Unit: mm Tolerance:  $\pm 0.5\text{mm}$  Except Specified

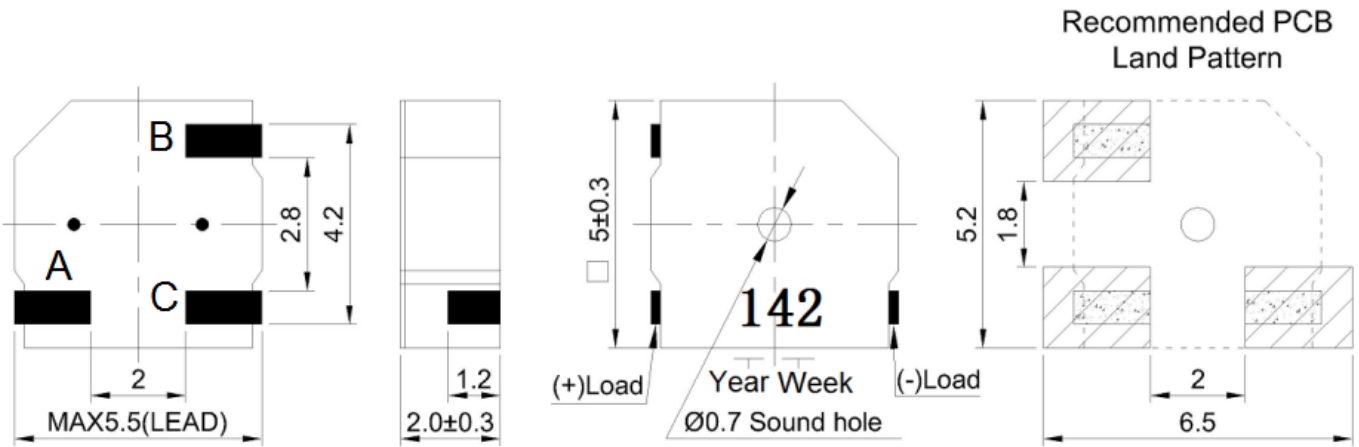

Coplanarity: Respect to A plane as stand, B&C have the tolerance 0~0.1mm.

OLE WOLFF ELEKTRONIK A/S Roedengvej 25 4180 Soroe Denmark  TEL: +45 57833830 FAX: +45 57820019	OLE WOLFF ELECTRONICS INC. 1525 McCarthy Blvd, Suite 1093 Milpitas, Ca 95035 USA  TEL: +1 408 888 8413	OLEWOLFF ELEKTRONIK GmbH Schulstrasse 15A. DE-25451 Quickborn. Germany  TEL: +49 (0) 4106 765900 FAX: +49 (0) 4106 627297	OLEWOLFF ELECTRONICS 3 Bedford Street, Woburn, Bedfordshire MK17 9QB, ENGLAND  TEL: +44 (0) 1525 290755 FAX: +44 (0) 1525 290855	OLE WOLFF ELEKTRONIK Yliopistonkatu 26 (P.O.BOX 257) FI-40101 Jyväskylä Finland  TEL: +358 14 338 3050 FAX: +358 14 338 3059	OLE WOLFF (ASIA) LTD. Unit B, 19/F., Bold Win Ind. Bldg., No. 16-18 Wah Sing St., Kwai Chung, N.T., H.K.  TEL: +852 2424 3274 FAX: +852 2424 2219	OLE WOLFF LTD. 5 Floor, Block G, WenTao Industrial Park, YingRenShi, Bao'an District, Shenzhen, PRC  TEL: +86 755 82612542 TEL: +86 755 26406156
---	---	--	--	--	--	---

	Date	13-Oct-2021	<b>SPECIFICATION</b>	OLE WOLFF
	Page	6 / 8		www.owolff.com
	CN	P/N: OWMB-505020S-40-12D		Revision: 02

**9. Recommended Temp. Profile for Reflow Oven (Figure 4)**

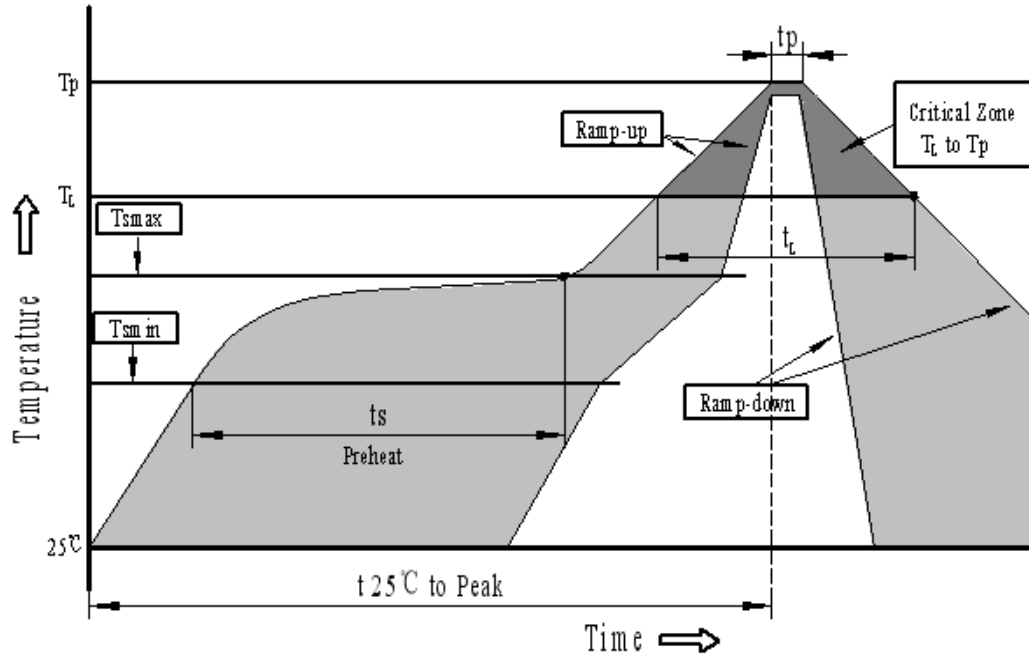

Profile Feature	Pb-Free Assembly
Average ramp-up rate( $T_L$ to $T_p$ )	3°C/second max.
Preheat	
-Temperature Min.( $T_{smin}$ )	150°C
-Temperature Min.( $T_{smax}$ )	200°C
-Temperature Min.( $t_s$ )	60~180 seconds
$T_{smax}$ to $T_L$	
-Ramp-up Rate	3°C/second max.
Time maintained above:	
- Temperature( $T_L$ )	217°C
-Time( $T_L$ )	60~150 seconds
Peak temperature( $T_p$ )	250°C+0/-5°C
Time within 5°C of actual Peak temperature ( $t_p$ )	6 seconds max.
Ramp-down Rate	6°C/second max.
Time 25°C to Peak Temperature	8 minutes max.

OLE WOLFF ELEKTRONIK A/S Roedengvej 25 4180 Soroe Denmark TEL: +45 57833830 FAX: +45 57820019	OLE WOLFF ELECTRONICS INC. 1525 McCarthy Blvd, Suite 1093 Milpitas, Ca 95035 USA TEL: +1 408 888 8413	OLEWOLFF ELEKTRONIK GmbH Schulstrasse 15A. DE-25451 Quickborn. Germany TEL: +49 (0) 4106 765900 FAX: +49 (0) 4106 627297	OLEWOLFF ELECTRONICS 3 Bedford Street, Woburn, Bedfordshire MK17 9QB, ENGLAND TEL: +44 (0) 1525 290755 FAX: +44 (0) 1525 290855	OLE WOLFF ELEKTRONIK Yliopistonkatu 26 (P.O.BOX 257) FI-40101 Jyväskylä Finland TEL: +358 14 338 3050 FAX: +358 14 338 3059	OLE WOLFF (ASIA) LTD. Unit B, 19/F., Bold Win Ind. Bldg., No. 16-18 Wah Sing St., Kwai Chung, N.T., H.K. TEL: +852 2424 3274 FAX: +852 2424 2219	OLE WOLFF LTD. 5 Floor, Block G, WenTao Industrial Park, YingRenShi, Bao'an District, Shenzhen, PRC TEL: +86 755 82612542 TEL: +86 755 26406156
---	---	--	--	--	--	---

	Date	13-Oct-2021	<b>SPECIFICATION</b>	OLE WOLFF
	Page	7 / 8		www.owolff.com
	CN	P/N: OWMB-505020S-40-12D		Revision: 02

**10. PACKAGE INFORMATION (Figure 5)**

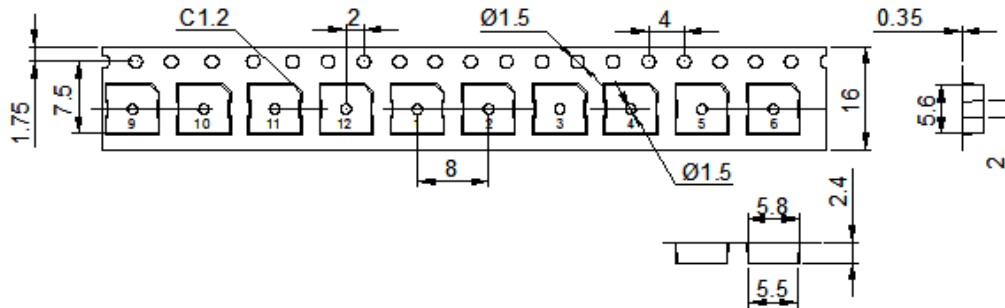

**NOTE:**

- 1.10 sprocket hole pitch cumulative tolerance +/-0.20mm.
- 2.All dimensions meet EIA-481-D requirements.
- 3.Thickness: 0.35+/-0.05mm.
- 4.Component loaded per 13"reel: 2500pcs.

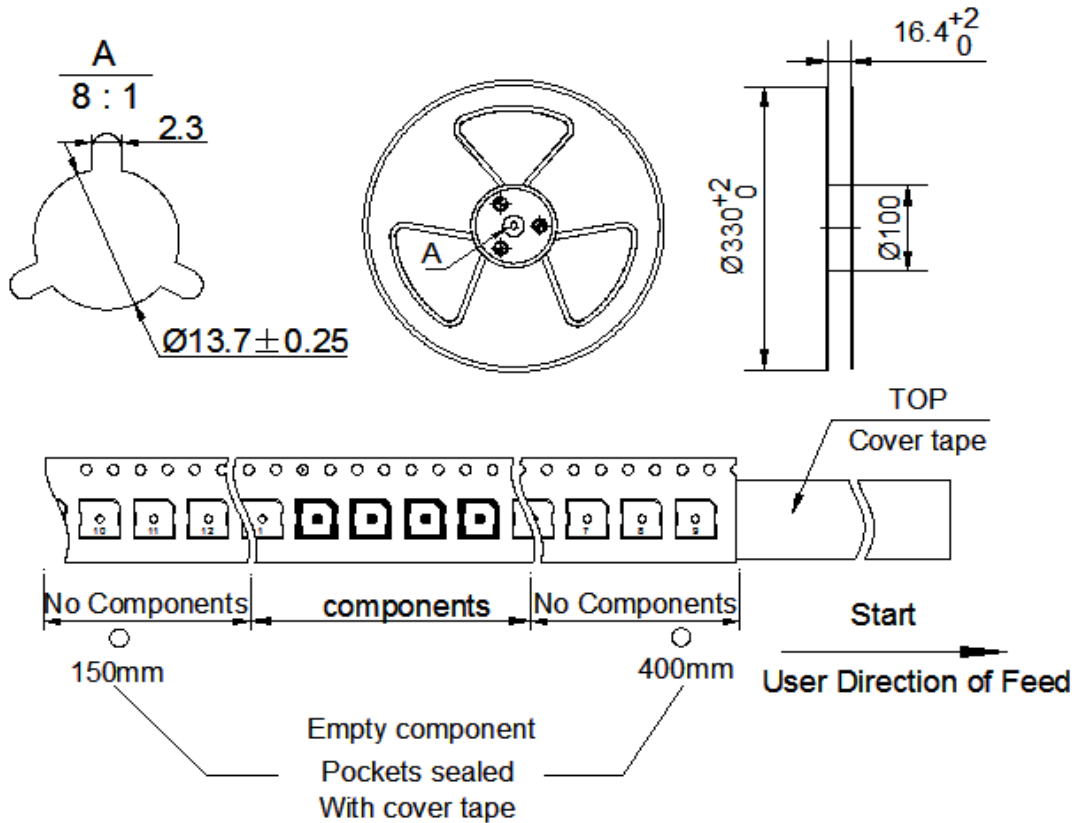

OLE WOLFF ELEKTRONIK A/S Roedengvej 25 4180 Soroe Denmark TEL: +45 57833830 FAX: +45 57820019	OLE WOLFF ELECTRONICS INC. 1525 McCarthy Blvd, Suite 1093 Milpitas, Ca 95035 USA TEL: +1 408 888 8413	OLEWOLFF ELEKTRONIK GmbH Schulstrasse 15A. DE-25451 Quickborn. Germany TEL: +49 (0) 4106 765900 FAX: +49 (0) 4106 627297	OLEWOLFF ELECTRONICS 3 Bedford Street, Woburn, Bedfordshire MK17 9QB, ENGLAND TEL: +44 (0) 1525 290755 FAX: +44 (0) 1525 290855	OLE WOLFF ELEKTRONIK Yliopistonkatu 26 (P.O.BOX 257) FI-40101 Jyväskylä Finland TEL: +358 14 338 3050 FAX: +358 14 338 3059	OLE WOLFF (ASIA) LTD. Unit B, 19/F, Bold Win Ind. Bldg., No. 16-18 Wah Sing St., Kwai Chung, N.T., H.K. TEL: +852 2424 3274 FAX: +852 2424 2219	OLE WOLFF LTD. 5 Floor, Block G, WenTao Industrial Park, YingRenShi, Bao'an District, Shenzhen, PRC TEL: +86 755 82612542 TEL: +86 755 26406156
---	---	--	--	--	---	---

	<b>Date</b>	<b>13-Oct-2021</b>	<b>SPECIFICATION</b>	<b>OLE WOLFF</b>
	<b>Page</b>	<b>8 / 8</b>		<b>www.owolff.com</b>
	<b>CN</b>	<b>P/N: OWMB-505020S-40-12D</b>		<b>Revision: 02</b>

**11. PACKAGE INFORMATION (Figure 6)**

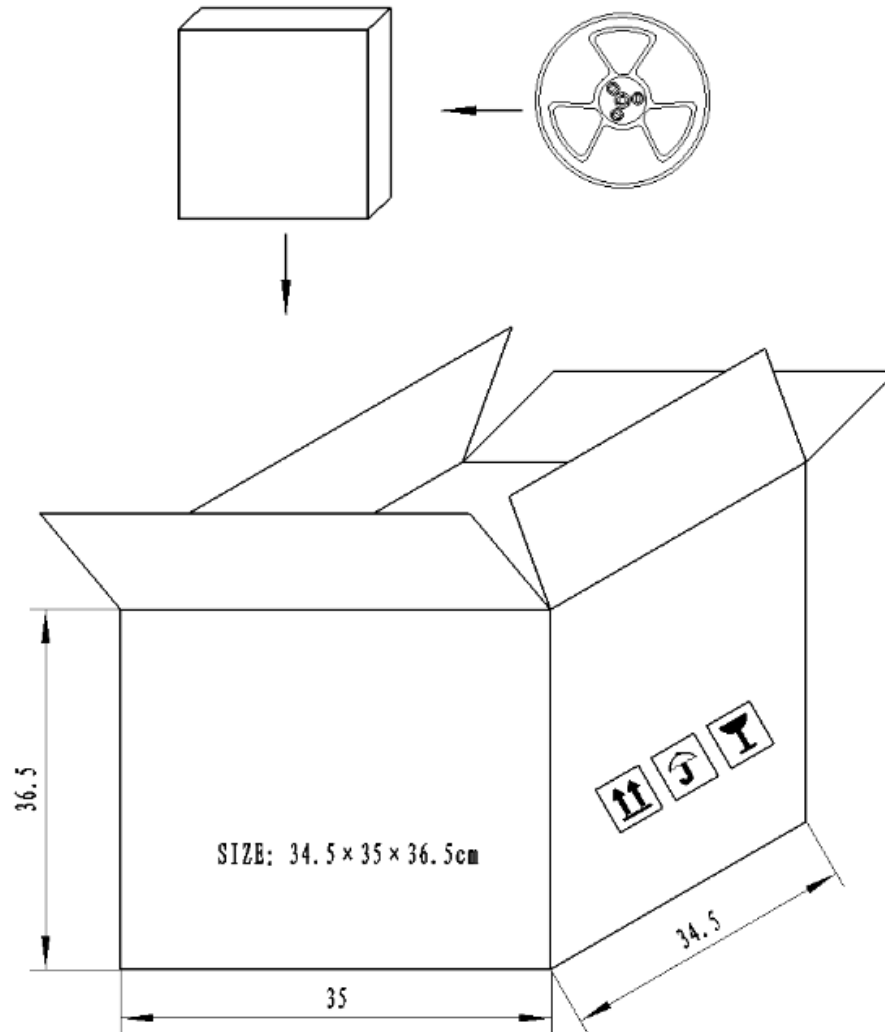

**NOTES:**

1. 2500 PCS per box
2. 10 boxes / carton 25000 PCS
3. 4 boxes / carton 10000 PCS

OLE WOLFF ELEKTRONIK A/S Roedengvej 25 4180 Soroe Denmark  TEL: +45 57833830 FAX: +45 57820019	OLE WOLFF ELECTRONICS INC. 1525 McCarthy Blvd, Suite 1093 Milpitas, Ca 95035 USA  TEL: +1 408 888 8413	OLEWOLFF ELEKTRONIK GmbH Schulstrasse 15A. DE-25451 Quickborn. Germany  TEL: +49 (0) 4106 765900 FAX: +49 (0) 4106 627297	OLEWOLFF ELECTRONICS 3 Bedford Street, Woburn, Bedfordshire MK17 9QB, ENGLAND  TEL: +44 (0) 1525 290755 FAX: +44 (0) 1525 290855	OLE WOLFF ELEKTRONIK Yliopistonkatu 26 (P.O.BOX 257) FI-40101 Jyväskylä Finland  TEL: +358 14 338 3050 FAX: +358 14 338 3059	OLE WOLFF (ASIA) LTD. Unit B, 19/F., Bold Win Ind. Bldg., No. 16-18 Wah Sing St., Kwai Chung, N.T., H.K.  TEL: +852 2424 3274 FAX: +852 2424 2219	OLE WOLFF LTD. 5 Floor, Block G, WenTao Industrial Park, YingRenShi, Bao'an District, Shenzhen, PRC  TEL: +86 755 82612542 TEL: +86 755 26406156
---	---	--	--	--	--	---