



ANSI/AAMI ES60601-1 BS EN/EN60601-1 IEC60601-1 TPTC004

■ Features

- 2.73"x1.53" compact size
- Medical safety approved (2 x MOPP) according to ANSI/AAMI ES60601-1 and IEC/BS EN/EN60601-1
- Suitable for BF application with appropriate system consideration
- No load power consumption < 0.075W
- Extremely low leakage current
- Wide operating temp. range -40 ~ +85°C
- EMI class B for class II configuration
- Protections: Short circuit / Overload / Over voltage
- No minimum load required
- 3 years warranty

■ Applications

- Portable medical device
- Mobile clinical workstation
- Medical computer monitor
- Medical examination instrument

■ GTIN CODE

MW Search: <https://www.meanwell.com/serviceGTIN.aspx>

■ Description

MPM-30 is a 30W high density and small size (69.5x39x24mm) AC/DC module type medical power supply series offered in pin type. It features the operation for 80~264VAC, a low no load power consumption less than 0.075W, a high efficiency up to 91%, Class II (no FG) double insulation, outstanding dissipation and high lifespan thanks to the interior potting, high EMC performance, 4KVAC isolation, etc. PCB mounting style model(Blank) meet the anti-vibration demand up to 2G and screw terminal style model (ST) meet the anti-vibration demand up to 5G .

The design observes IEC/BS EN/EN60601-1 and ANSI/AAMI ES60601-1 version three with 2xMOPP level and ultra-low leakage current (<80 μA). It is very suitable for BF (patient contact) type medical device or relevant equipment. In addition to PCB mounting style, MPM-30 series also offers the screw terminal style model (ST).

■ Model Encoding

MPM - 30 - 5 ST

Blank : PCB mounting style
ST : Screw terminal style

Output voltage
Rated wattage
Series name

MODEL		MPM-30-3.3□	MPM-30-5□	MPM-30-12□	MPM-30-15□	MPM-30-24□	MPM-30-48□	
OUTPUT	DC VOLTAGE	3.3V	5V	12V	15V	24V	48V	
	RATED CURRENT	6A	6A	2.5A	2A	1.3A	0.63A	
	CURRENT RANGE <small>Note.2</small>	0 ~ 6A	0 ~ 6A	0 ~ 2.5A	0 ~ 2A	0 ~ 1.3A	0 ~ 0.63A	
	PEAK CURRENT	7.8A	6.9A	2.9A	2.3A	1.5A	0.73A	
	RATED POWER	19.8W	30W	30W	30W	31.2W	30.2W	
	PEAK LOAD(10sec.) <small>Note.3</small>	25.7W	34.5W	34.8W	34.5W	36W	35W	
	RIPPLE & NOISE (max.) <small>Note.4</small>	80mVp-p	80mVp-p	120mVp-p	120mVp-p	200mVp-p	200mVp-p	
	VOLTAGE TOLERANCE <small>Note.5</small>	±2.0%	±2.0%	±2.0%	±2.0%	±2.0%	±2.0%	
	LINE REGULATION	±0.5%	±0.5%	±0.5%	±0.5%	±0.5%	±0.5%	
	LOAD REGULATION	±1.0%	±1.0%	±0.5%	±0.5%	±0.5%	±0.5%	
SETUP, RISE TIME	500ms, 30ms/230VAC 500ms, 30ms/115VAC at full load							
HOLD UP TIME (Typ.)	40ms/230VAC 12ms/115VAC at full load							
INPUT	VOLTAGE RANGE <small>Note.6</small>	80 ~ 264VAC						
	FREQUENCY RANGE	47 ~ 63Hz						
	EFFICIENCY (Typ.)	82.5%	86.5%	90%	89%	90%	91%	
	AC CURRENT (Typ.)	0.75A/115VAC 0.5A/230VAC						
	INRUSH CURRENT (Typ.)	COLD START 25A/115VAC 45A/230VAC						
LEAKAGE CURRENT (max.) <small>Note.7</small>	Touch current <80 μ A/264VAC							
PROTECTION	OVERLOAD	115% ~ 165% rated output power Protection type : Hiccup mode, recovers automatically after fault condition is removed						
	OVER VOLTAGE	3.5 ~ 4.5V	5.3 ~ 6.8V	12.6 ~ 16.2V	15.8 ~ 20.3V	25.2 ~ 32.4V	50.4 ~ 64V	
ENVIRONMENT	WORKING TEMP.	-40 ~ +85 $^{\circ}$ C (Refer to "Derating Curve")						
	WORKING HUMIDITY	20 ~ 90% RH non-condensing						
	STORAGE TEMP., HUMIDITY	-40 ~ +85 $^{\circ}$ C, 10 ~ 95% RH non-condensing						
	TEMP. COEFFICIENT	±0.03%/ $^{\circ}$ C (0 ~ 60 $^{\circ}$ C)						
	SOLDERING TEMPERATURE	Wave soldering: 265 $^{\circ}$ C, 5s (max.); Manual soldering: 390 $^{\circ}$ C, 3s (max.)						
	VIBRATION	Blank: 10 ~ 500Hz, 2G 10min./1cycle, period for 60min. each along X, Y, Z axes ST: 10 ~ 500Hz, 5G 10min./1cycle, period for 60min. each along X, Y, Z axes						
	OPERATING ALTITUDE <small>Note.8</small>	PCB mounting: 5000 meters Screw terminal style: 3000 meters						
SAFETY & EMC (Note 9)	SAFETY STANDARDS	IEC60601-1, BS EN/EN60601-1, EAC TP TC 004, UL ANSI/AAMI ES60601-1(3.1 version), CAN/CSA-C22 3 rd Edition approved; Design refer to BS EN/EN60335-1(by request)						
	ISOLATION LEVEL	Primary-Secondary: 2xMOPP						
	WITHSTAND VOLTAGE	I/P-O/P: 4KVAC						
	ISOLATION RESISTANCE	I/P-O/P: 100M Ohms / 500VDC / 25 $^{\circ}$ C / 70% RH						
	EMC EMISSION	Parameter	Standard				Test Level / Note	
		Conducted	BS EN/EN55011 (CISPR11)				Class B	
		Radiated	BS EN/EN55011 (CISPR11)				Class B	
		Harmonic Current	BS EN/EN61000-3-2				Class A	
	Voltage Flicker	BS EN/EN61000-3-3				----		
	EMC IMMUNITY	BS EN/EN55035, BS EN/EN60601-1-2						
		Parameter	Standard				Test Level / Note	
		ESD	BS EN/EN61000-4-2				Level 4, 15KV air ; Level 4, 8KV contact	
		RF field susceptibility	BS EN/EN61000-4-3				Level 3, 10V/m(80MHz~2.7GHz) Table 9, 9~28V/m(385MHz~5.78GHz)	
EFT bursts		BS EN/EN61000-4-4				Level 3, 2KV		
Surge susceptibility		BS EN/EN61000-4-5				Level 3, 1KV/Line-Line		
Conducted susceptibility		BS EN/EN61000-4-6				Level 3, 10V		
Magnetic field immunity	BS EN/EN61000-4-8				Level 4, 30A/m			
Voltage dip, interruption	BS EN/EN61000-4-11				100% dip 1 periods, 30% dip 25 periods, 100% interruptions 250 periods			
OTHERS	MTBF	6325.8K hrs min. Telcordia SR-332 (Bellcore) ; 778.9K hrs min. MIL-HDBK-217F (25 $^{\circ}$ C)						
	DIMENSION	PCB mounting style: 69.5*39*24mm (L*W*H) or 2.73**1.53**0.94" inch Screw terminal style: 91*39.5*28.5mm (L*W*H) or 3.58**1.55**1.12" inch						
	PACKING	PCB mounting style: 0.102Kg; 144pcs/15.7Kg/0.97CUFT Screw terminal style : 0.12Kg; 120pcs/14.9Kg/0.74CUFT						
NOTE	<ol style="list-style-type: none"> All parameters NOT specially mentioned are measured at 230VAC input, rated load and 25$^{\circ}$C of ambient temperature. No minimum load required. 33% Duty cycle maximum within every 30 seconds. Average output power should not exceed the rated power. Ripple & noise are measured at 20MHz of bandwidth by using a 12" twisted pair-wire terminated with a 0.1 μf & 47 μf parallel capacitor. Tolerance : includes set up tolerance, line regulation and load regulation. Derating may be needed under low input voltages. Please check the derating curve for more details. Touch current was measured from primary input to DC output. The ambient temperature derating of 3.5$^{\circ}$C/1000m with fanless models and of 5$^{\circ}$C/1000m with fan models for operating altitude higher than 2000m(6500ft). The power supply is considered a component which will be installed into a final equipment. The final equipment must be re-confirmed that it still meets EMC directives. For guidance on how to perform these EMC tests, please refer to "EMI testing of component power supplies." (as available on http://www.meanwell.com) <p>※ Product Liability Disclaimer : For detailed information, please refer to https://www.meanwell.com/serviceDisclaimer.aspx</p>							

Block Diagram

fosc : 65KHz

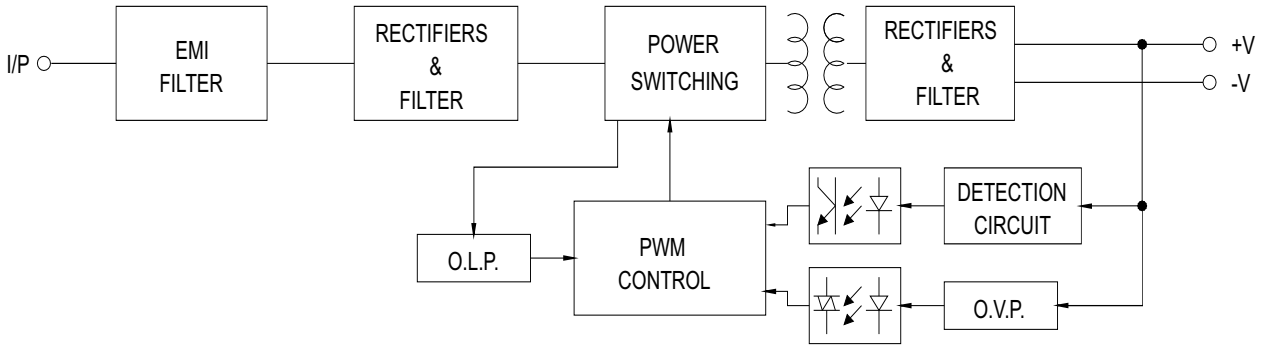

Derating Curve

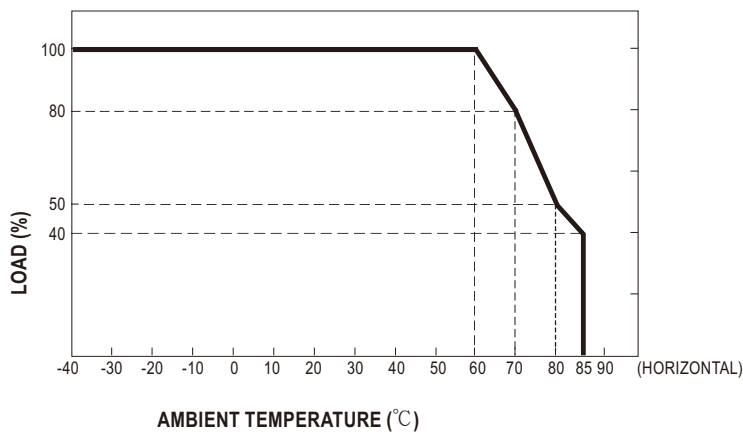

Output Derating VS Input Voltage

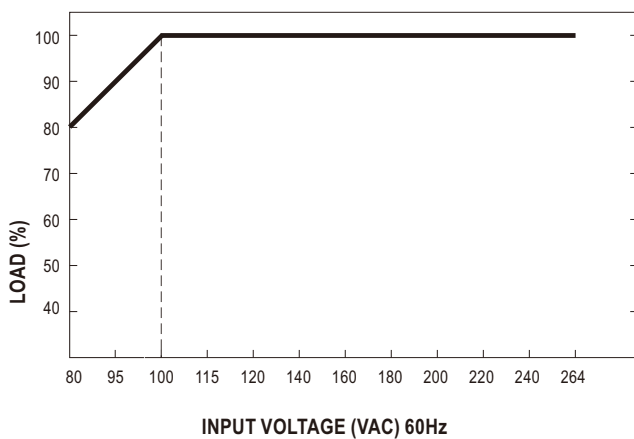

Mechanical Specification

Case No. Unit:mm

• MPM-30 (PCB mounting style)

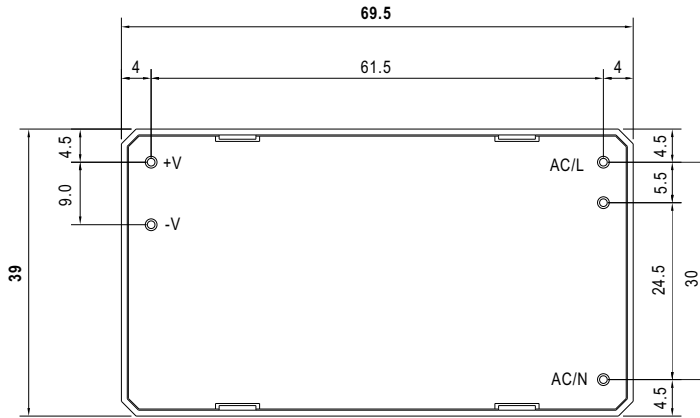

BOTTOM VIEW

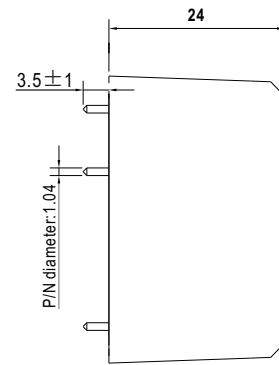

SIDE VIEW

• MPM-30-ST (Screw terminal style)

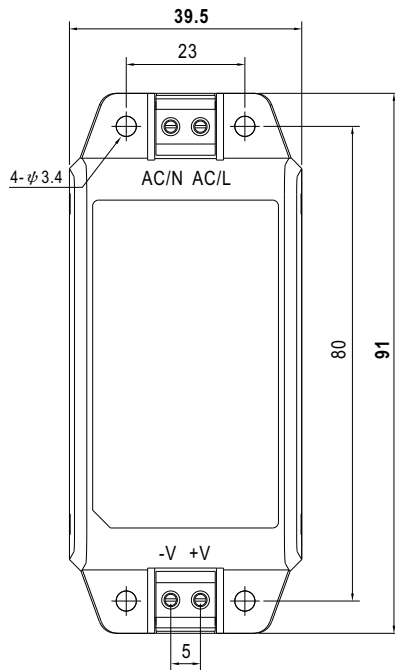

TOP VIEW

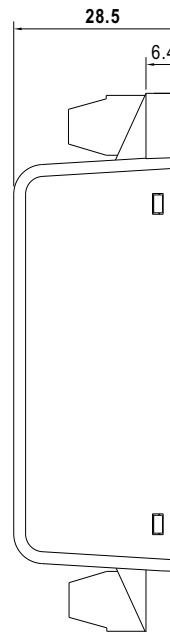

SIDE VIEW

Installation Manual

Please refer to : <http://www.meanwell.com/manual.html>