

Silicon Power Schottky Diode

$V_{RRM} = 150\text{ V} - 200\text{ V}$

$I_{F(AV)} = 600\text{ A}$

Features

- High Surge Capability
- Types from 150 V to 200 V V_{RRM}
- Not ESD Sensitive

Twin Tower Package

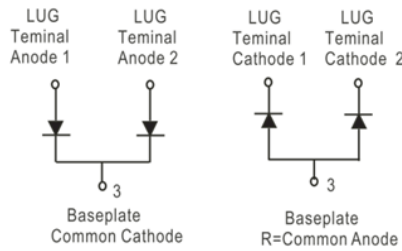

Maximum ratings, at $T_j = 25\text{ }^\circ\text{C}$, unless otherwise specified ("R" devices have leads reversed)

Parameter	Symbol	Conditions	MBR600150CT (R)	MBR600200CT (R)	Unit
Repetitive peak reverse voltage	V_{RRM}		150	200	V
RMS reverse voltage	V_{RMS}		106	141	V
DC blocking voltage	V_{DC}		150	200	V
Operating temperature	T_j		-55 to 150	-55 to 150	$^\circ\text{C}$
Storage temperature	T_{stg}		-55 to 150	-55 to 150	$^\circ\text{C}$

Electrical characteristics, at $T_j = 25\text{ }^\circ\text{C}$, unless otherwise specified

Parameter	Symbol	Conditions	MBR600150CT (R)	MBR600200CT (R)	Unit
Average forward current (per pkg)	$I_{F(AV)}$	$T_C = 125\text{ }^\circ\text{C}$	600	600	A
Peak forward surge current (per leg)	I_{FSM}	$t_p = 8.3\text{ ms}$, half sine	4000	4000	A
Maximum forward voltage (per leg)	V_F	$I_{FM} = 300\text{ A}$, $T_j = 25\text{ }^\circ\text{C}$	0.88	0.92	V
Reverse current at rated DC blocking voltage (per leg)	I_R	$T_j = 25\text{ }^\circ\text{C}$ $T_j = 100\text{ }^\circ\text{C}$ $T_j = 150\text{ }^\circ\text{C}$	3 10 50	3 10 50	mA

Thermal characteristics

Parameter	Symbol	Conditions	MBR600150CT (R)	MBR600200CT (R)	Unit
Thermal resistance, junction-case (per leg)	$R_{\theta JC}$		0.28	0.28	$^\circ\text{C/W}$

Figure .1- Typical Forward Characteristics

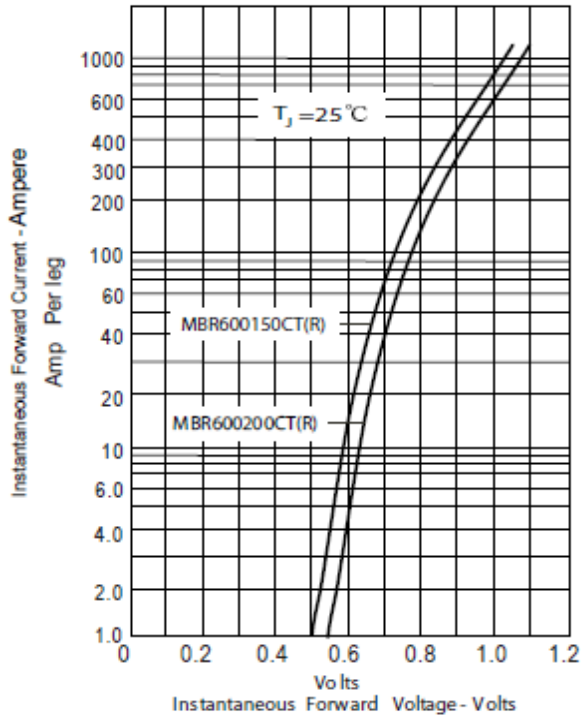

Figure .2- Forward Derating Curve

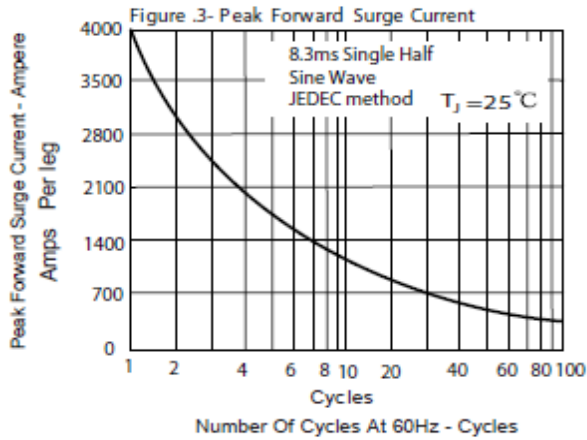
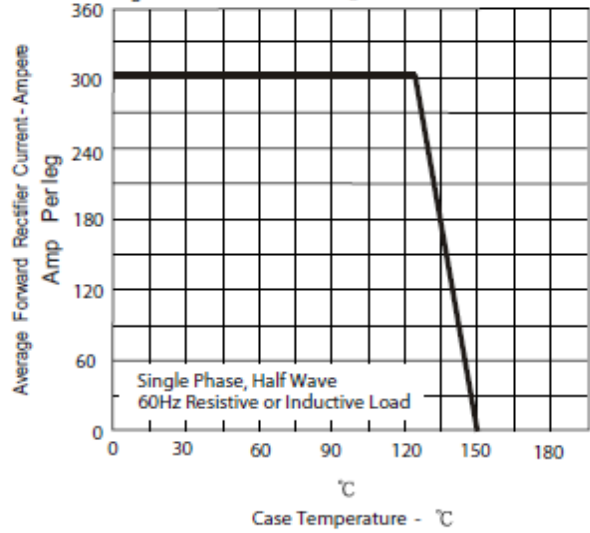
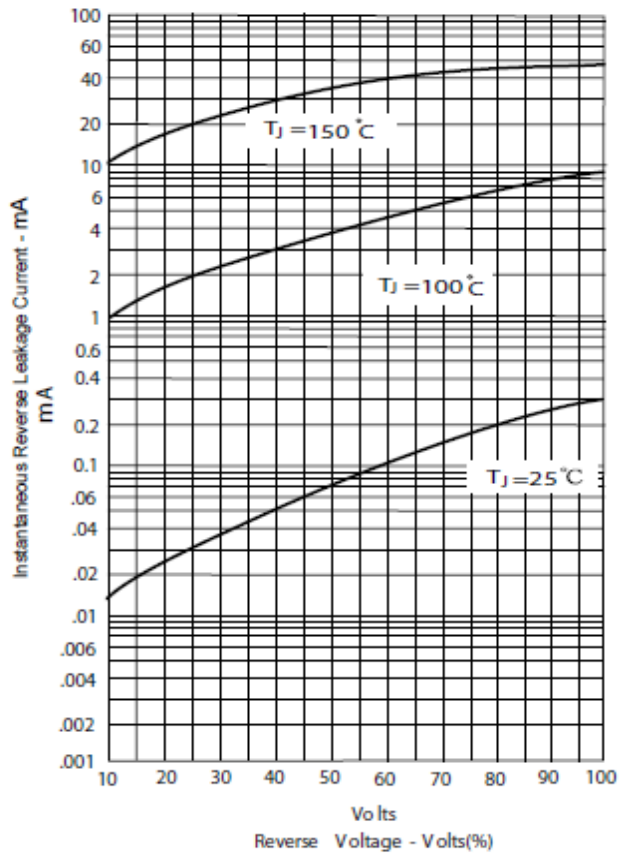
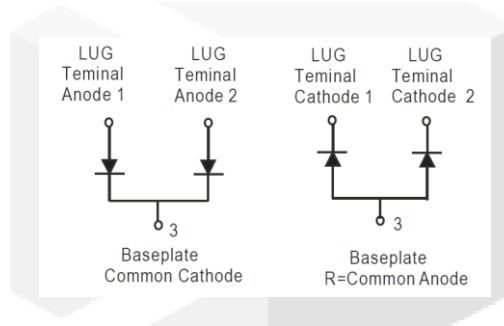
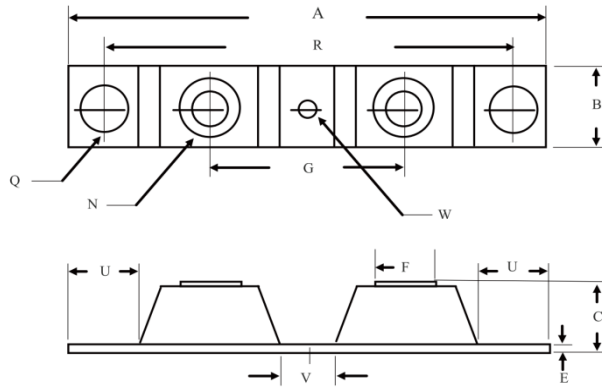

Figure .4- Typical Reverse Characteristics



Package dimensions and terminal configuration

Product is marked with part number and terminal configuration.



DIM	Inches		Millimeters	
	Min	Max	Min	Max
A	----	3.630	----	92.40
B	0.700	0.800	17.78	20.32
C	----	0.650	----	16.51
E	0.130	0.141	3.30	3.60
F	0.482	0.490	12.25	12.45
G	1.368	BSC	34.75	BSC
N	1/4-20 UNC FULL			
Q	0.275	0.290	6.99	7.37
R	3.150	BSC	80.01	BSC
U	0.600	----	15.24	----
V	0.312	0.370	7.92	9.40
W	0.180	0.195	4.57	4.95