



ACMP-9050 Series

Request Samples



Check Inventory



9.0 x 7.0 x 5.0mm
RoHS/RoHS II Compliant
 MSL Level = 1

Features

- Commercial Grade
- PPAP ready and supported
- Excellent impedance characteristics
- Rated current up to 6A
- Extremely Low DCR

Applications

- DC power line common mode noise suppression.
- Switch Mode Power Supplies and regulators
- Variable Frequency Drives
- AC/DC power rectifiers

Electrical Specifications

Part Number	Impedance (Ω) @100MHz		DCR (mΩ)	Rated Current (A)	Rated Voltage (Vdc)	Insulation Resistance (MΩ)
	Min	Typ.	Max	Typ.	Max	Min
ACMP-9050-301	225	300	6	6.0	125	10
ACMP-9050-601	450	600	8	5.5	125	10
ACMP-9050-701	500	700	10	5.0	125	10
ACMP-9050-102	750	1000	13	4.0	125	10
ACMP-9050-132	1000	1300	17	4.0	125	10
ACMP-9050-172	1200	1700	20	4.0	125	10
ACMP-9050-222	1700	2200	60	2.5	125	10
ACMP-9050-272	2000	2700	65	2.5	125	10
ACMP-9050-302	2500	3000	70	1.9	125	10

Rated Current is based on an Irms temperature rise of 40°C.

Operating Temperature: -40°C to +125°C. (Including self-heating)

Storage (in original packaging): <40°C, <60% RH.

ACMP-9050 Series is [RoHS Compliant](#) and [Pb free](#).



ACMP-9050 Series

Request Samples



Check Inventory



9.0 x 7.0 x 5.0mm
 RoHS/RoHS II Compliant
 MSL Level = 1

Electrical Specifications (Cont'd)

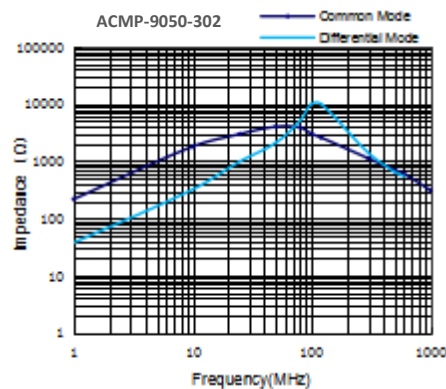
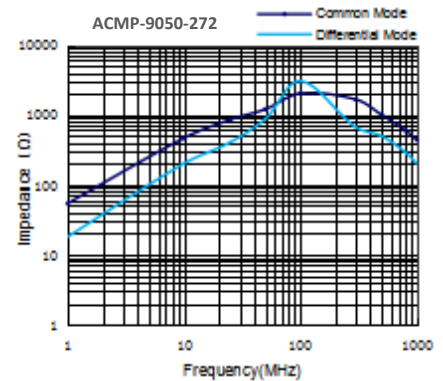
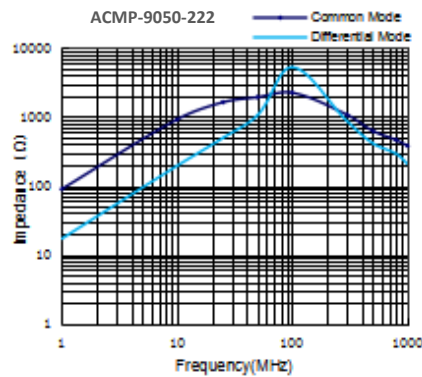
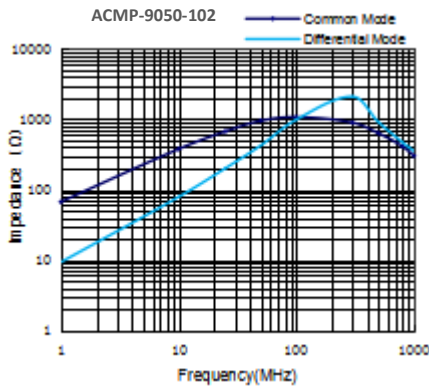
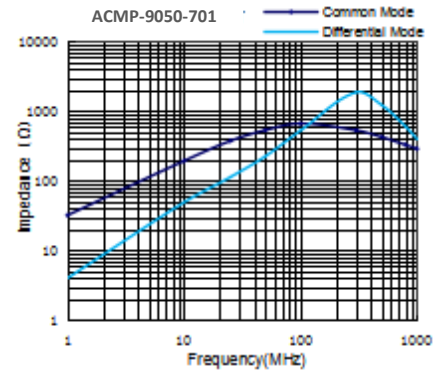
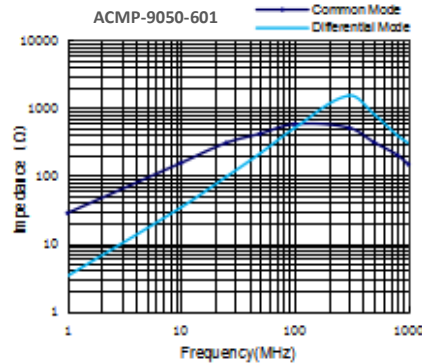
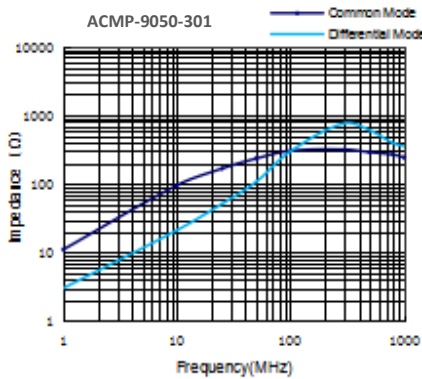

Power Common Mode Chokes



ACMP-9050 Series

Request Samples



Check Inventory



9.0 x 7.0 x 5.0mm
RoHS/RoHS II Compliant
MSL Level = 1

Mechanical Specifications

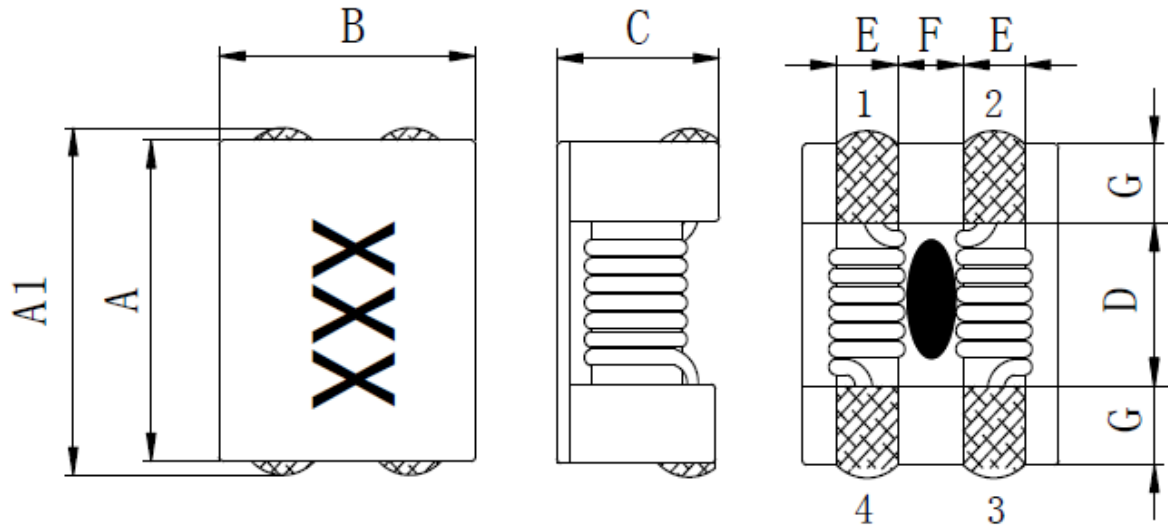

A	A1	B	C	D	E	F	G
9.0 ± 0.5	9.5 ± 0.6	7.0 ± 0.5	5.0 MAX	5.7 Ref.	1.5 Ref	2.0 Ref.	1.7 Ref.

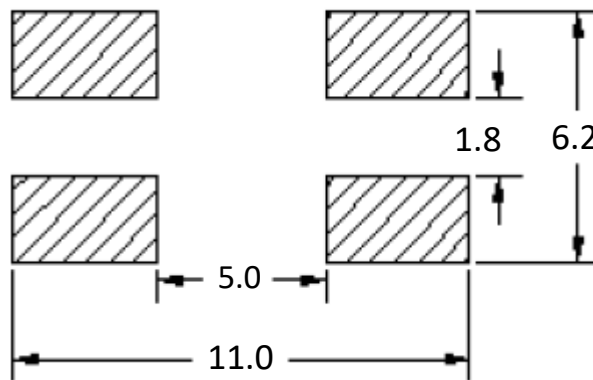

Recommended Layout

Dimensions: mm

Power Common Mode Chokes



ACMP-9050 Series

Request Samples



Check Inventory



9.0 x 7.0 x 5.0mm
RoHS/RoHS II Compliant
MSL Level = 1

Schematic

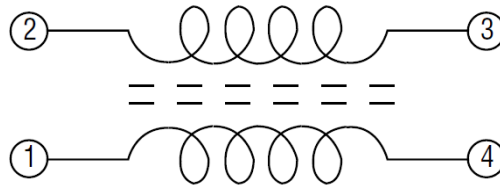

Materials

Description	Specification
Core	Ferrite core
Wire	Enameled copper wire
Base	Plastic
Adhesive	Epoxy resin
Terminal	Sn/Cu
Ink	White

Part Identification

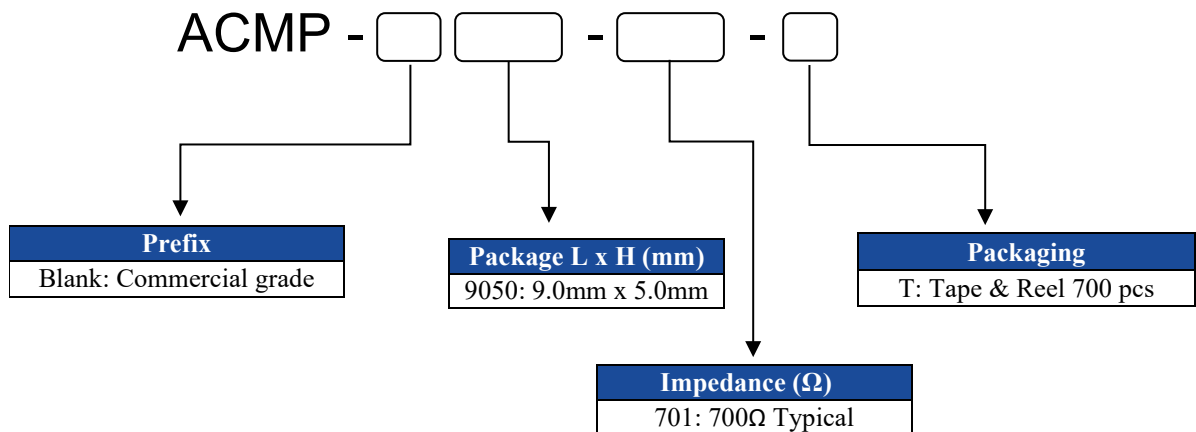



ACMP-9050 Series

Request Samples



Check Inventory



9.0 x 7.0 x 5.0mm
RoHS/RoHS II Compliant
 MSL Level = 1

Reflow Profile

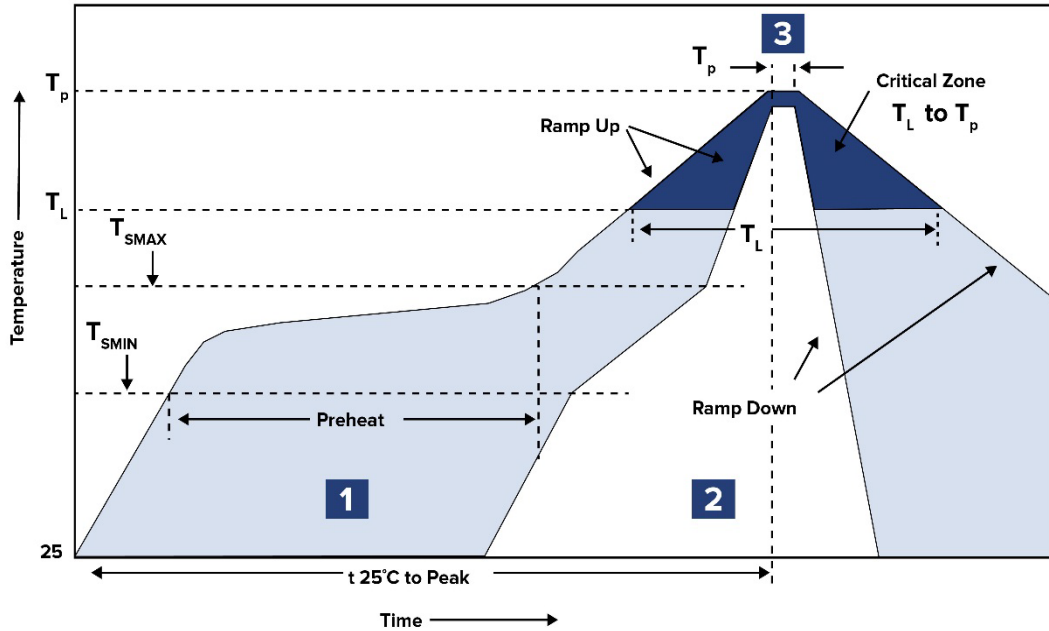

Zone	Description	Temperature	Times
1	Preheat	$T_{SMIN} \sim T_{SMAX}$ 150°C ~ 190°C	60 ~ 120 sec.
2	Reflow	T_L 240°C	20 ~ 40 sec.
3	Peak heat	T_P 260°C Max.	5 sec. Max

1~2 °C/Sec. Ramp

Power Common Mode Chokes



ACMP-9050 Series

Request Samples



Check Inventory



9.0 x 7.0 x 5.0mm
RoHS/RoHS II Compliant
MSL Level = 1

Packing

Tape & Reel: 700pcs/reel

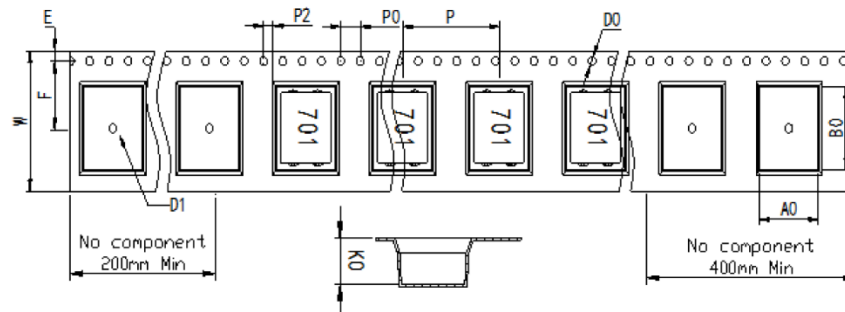
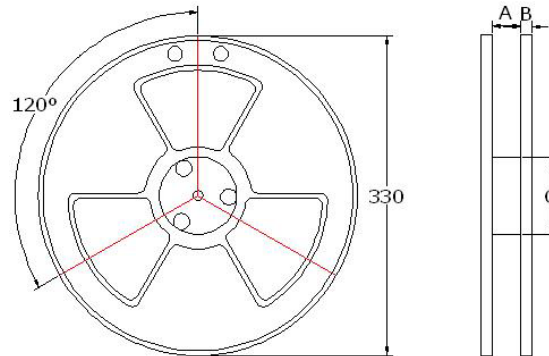

W	P	P0	P2	D0	E	F	A0	B0	K0
24 ± 0.30	16 ± 0.10	4.0 ± 0.10	2.0 ± 0.10	1.5 ± 0.10	1.75 ± 0.10	11.5 ± 0.10	7.6 ± 0.10	9.6 ± 0.10	5.1 ± 0.10

Dimensions: mm

ATTENTION: Abracon LLC's products are COTS – Commercial-Off-The-Shelf products; suitable for Commercial, Industrial and, where designated, Automotive Applications. Abracon's products are not specifically designed for Military, Aviation, Aerospace, Life-dependent Medical applications or any application requiring high reliability where component failure could result in loss of life and/or property. For applications requiring high reliability and/or presenting an extreme operating environment, written consent and authorization from Abracon LLC is required. Please contact Abracon LLC for more information.



5101 Hidden Creek Ln Spicewood TX 78669
 Phone: 512-371-6159 | Fax: 512-351-8858
 For terms and conditions of sales, please visit:
www.abracon.com

REVISION: A 08-04-23

ABRACON IS
 ISO9001-2015
 CERTIFIED