

Display ▪ Surface-mount ELSS-205SYGWA/S530-E2/S290



Features

- Industrial standard size.
- Packaged in tape and reel for SMT manufacturing.
- The thickness is thinner than traditional display.
- Low power consumption.
- Categorized for luminous intensity.
- The product itself will remain with RoHS compliant version.
- Compliance with EU REACH.
- Compliance with Pb free. (Br < 900ppm, Cl < 900ppm, Br+Cl < 1500ppm)

Description

- The ELSS-205SYGWA/S530-E2/S290 is a 5.08mm (0.2") digit height seven-segment display.
- The display provides excellent reliability in bright ambient light.
- The device is made with white segments and gray surface.

Applications

- Home appliances.
- Instrument panels.
- Digital readout displays.

Device Selection Guide

| Chip Materials | Emitted Color | Resin Color |
|----------------|------------------------|-----------------|
| AlGaInP | Brilliant Yellow Green | White Diffusion |

Absolute Maximum Ratings (Ta=25°C)

| Parameter | Symbol | Rating | Unit |
|---|-----------|------------|------|
| Reverse Voltage | V_R | 5 | V |
| Forward Current | I_F | 25 | mA |
| Peak Forward Current (Duty 1/10 @1KHz) | I_{FP} | 60 | mA |
| Power Dissipation | P_d | 60 | mW |
| Operating Temperature | T_{opr} | -40 ~ +105 | °C |
| Storage Temperature | T_{stg} | -40 ~ +105 | °C |
| Soldering Temperature (Soldering time ≤ 5 seconds) | T_{sol} | 260 | °C |

Electro-Optical Characteristics (Ta=25°C)

| Parameter | Symbol | Min. | Typ. | Max. | Unit | Condition |
|------------------------------|-----------------|-------|-------|-------|------|------------|
| Luminous Intensity*1 | I_V | 4.0 | 8.9 | ----- | mcd | $I_F=10mA$ |
| Peak Wavelength | λ_p | ----- | 575 | ----- | nm | $I_F=20mA$ |
| Dominant Wavelength | λ_d | ----- | 573 | ----- | nm | $I_F=20mA$ |
| Spectrum Radiation Bandwidth | $\Delta\lambda$ | ----- | 20 | ----- | nm | $I_F=20mA$ |
| Forward Voltage | V_F | ----- | 2.0 | 2.4 | V | $I_F=20mA$ |
| Reverse Current | I_R | ----- | ----- | 10 | μA | $V_R=5V$ |

Note:

- Luminous Intensity is a average value which is measured one 7-segment.
- Tolerance of Luminous Intensity: ± 10 %
- Tolerance of Forward Voltage: ± 0.1V

Bin Range of Luminous Intensity

| Bin Code | Min. | Max. | Unit | Condition |
|----------|------|------|------|---------------------|
| N | 4.0 | 6.4 | mcd | $I_F = 10\text{mA}$ |
| P | 5.6 | 8.9 | | |
| Q | 7.8 | 12.5 | | |
| R | 11.0 | 17.6 | | |
| S | 15.0 | 24.0 | | |
| T | 21.0 | 34.0 | | |

Typical Electro-Optical Characteristics Curves

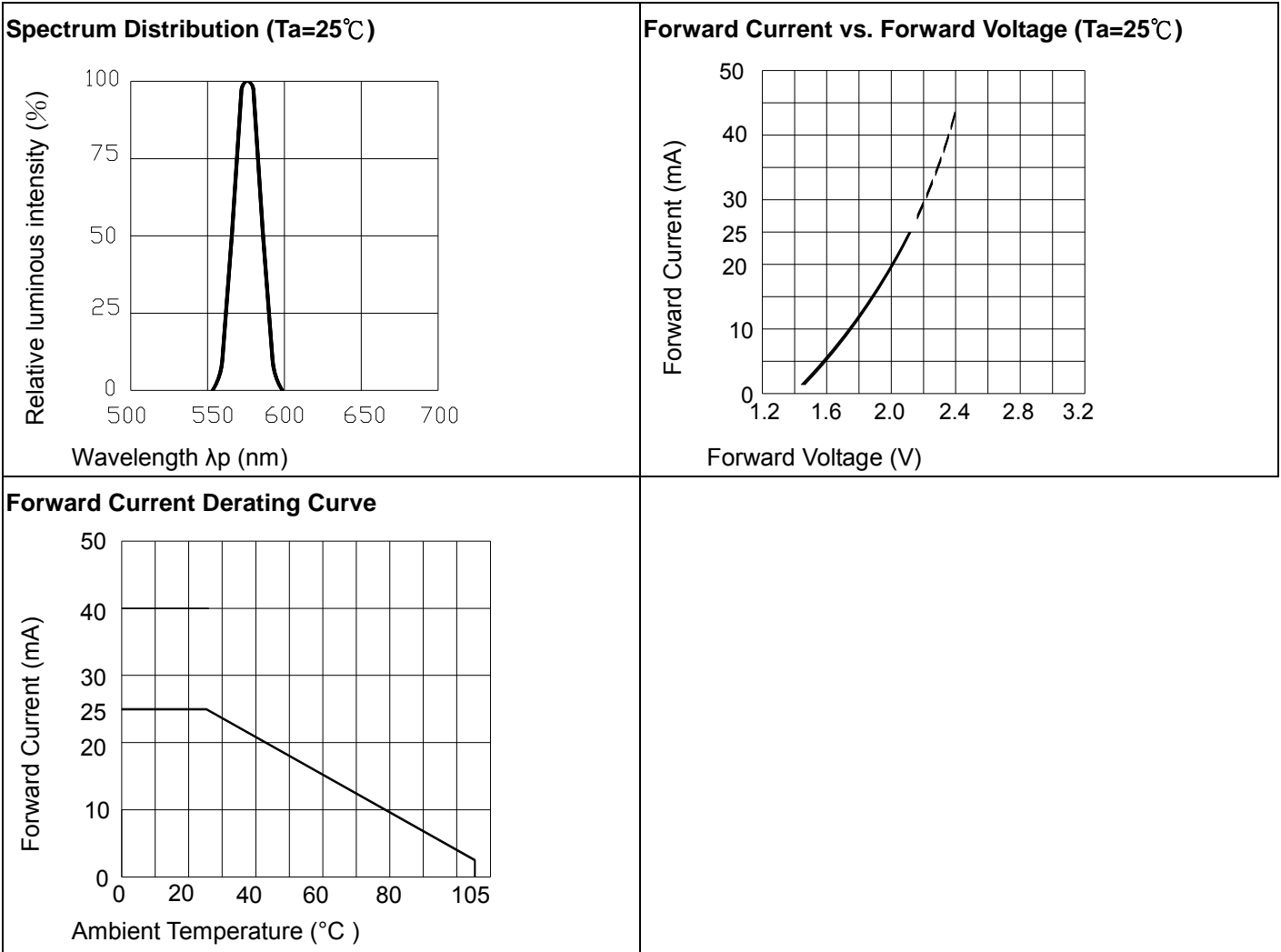

Package Dimension & Internal Circuit Diagram

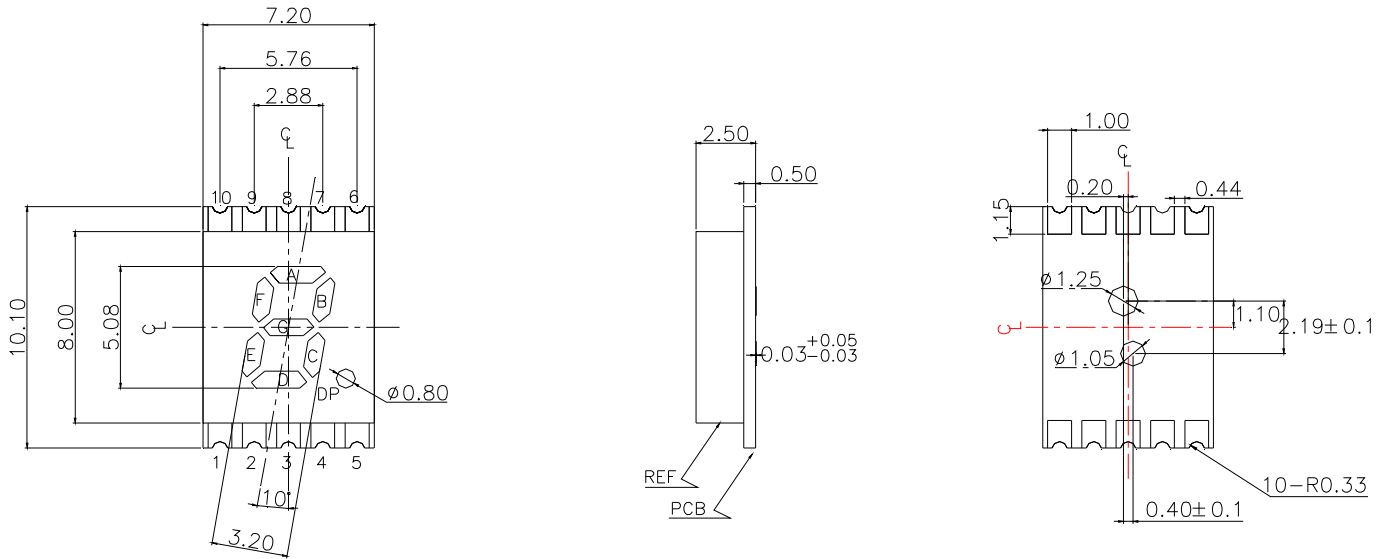

Internal Connection Diagram

- 1. Anode E
- 2. Anode D
- 3. Common Cathode
- 4. Anode C
- 5. Anode DP
- 6. Anode B
- 7. Anode A
- 8. Common Cathode
- 9. Anode F
- 10. Anode G

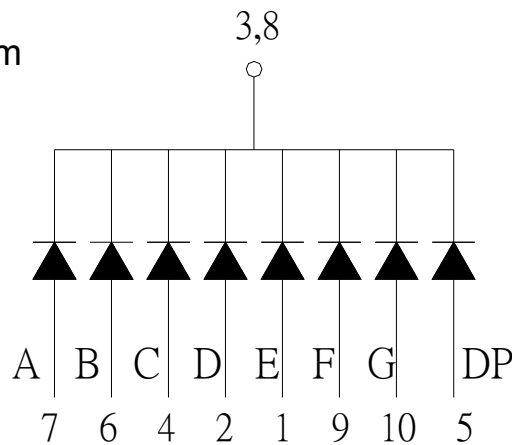

Note: Tolerances unless mentioned $\pm 0.25\text{mm}$. Unit = mm

Packing Materials

Label Explanation

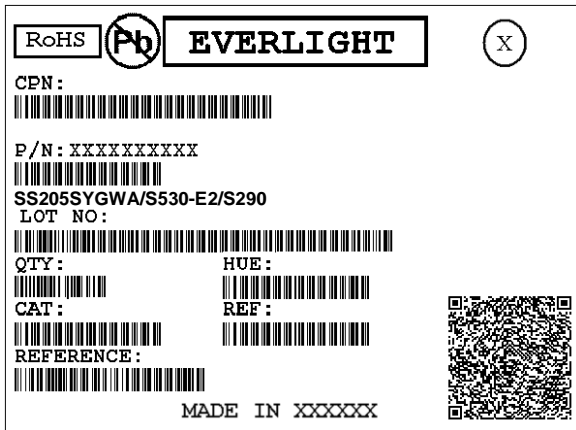

- CPN: Customer's Product Number
- P/N: Product Number
- QTY: Packing Quantity
- CAT: Luminous Intensity Rank
- HUE: Reference
- REF: Reference
- LOT No: Lot Number
- REFERENCE: Volume Label code

Reel Dimensions

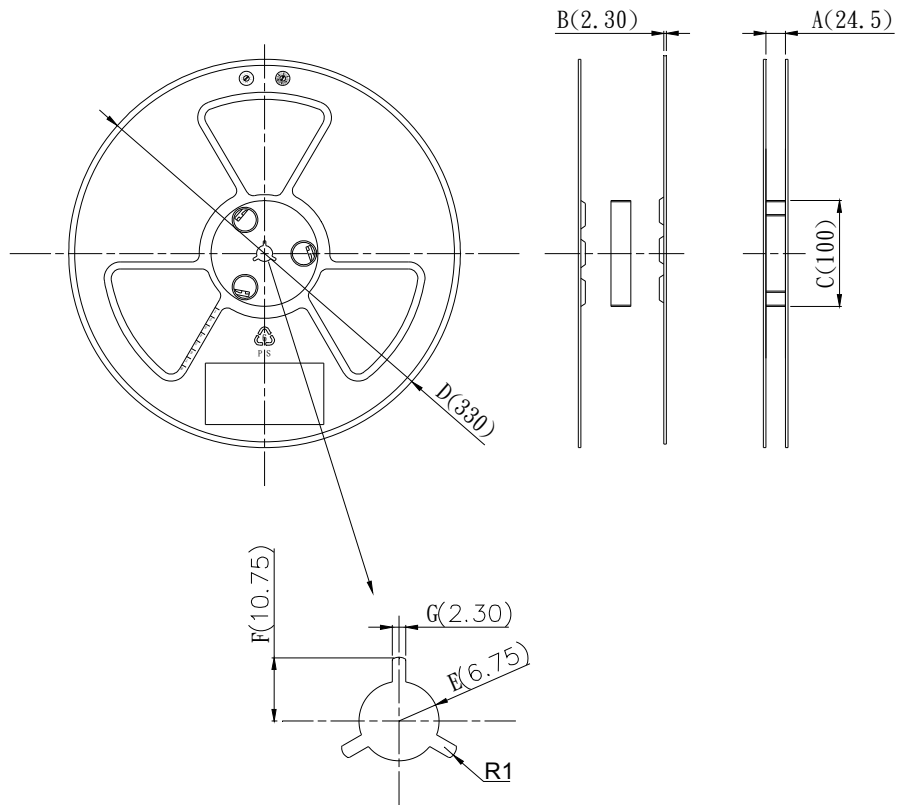

Carrier Tape Dimensions: Loaded Quantity 1500 PCS Per Reel

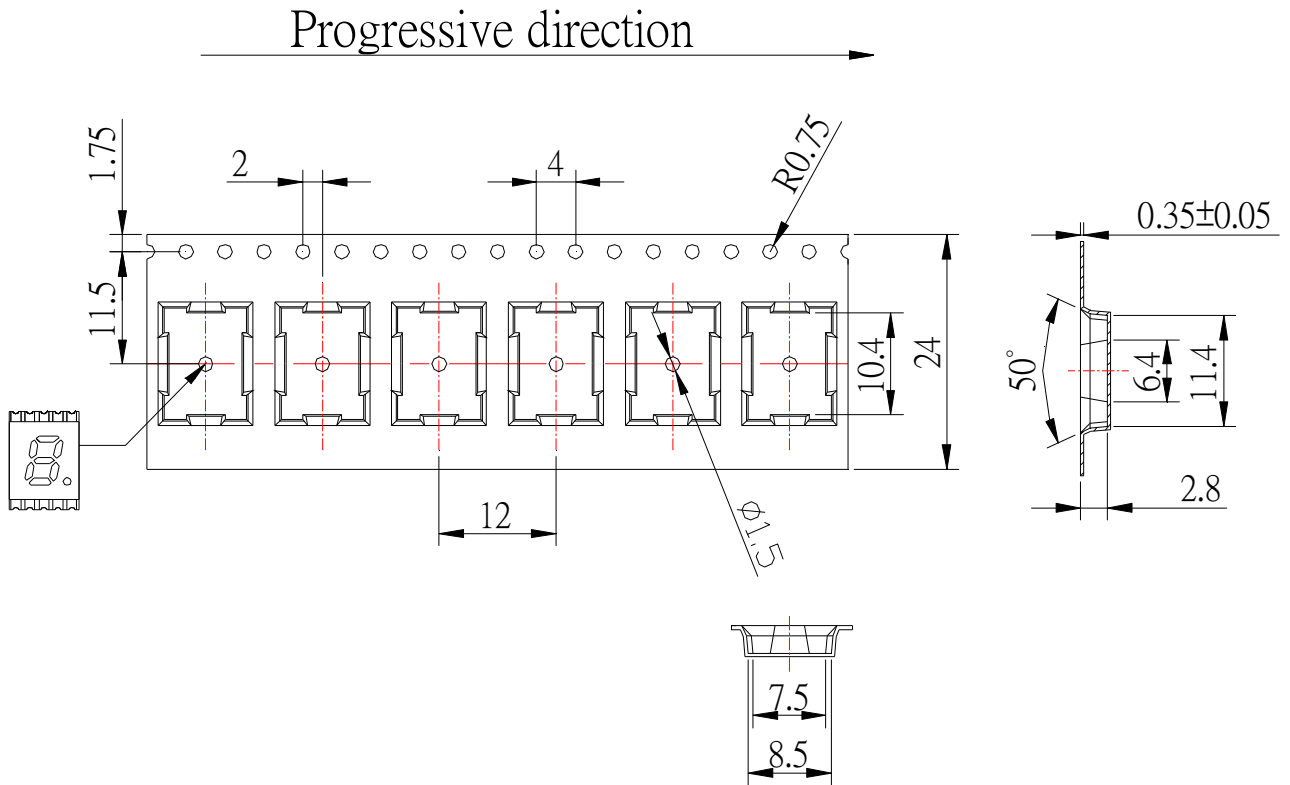

Note: Tolerances unless mentioned $\pm 0.25\text{mm}$. Unit = mm

Packing Process

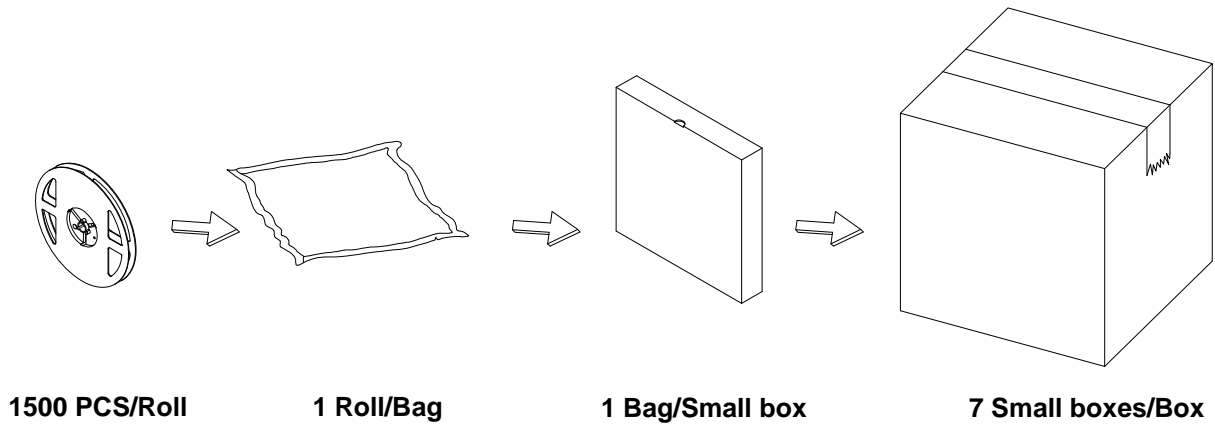

Precautions for Use

1. Soldering Condition

1.1 (A) Maximum Body Case Temperature Profile for evaluation of Reflow Profile

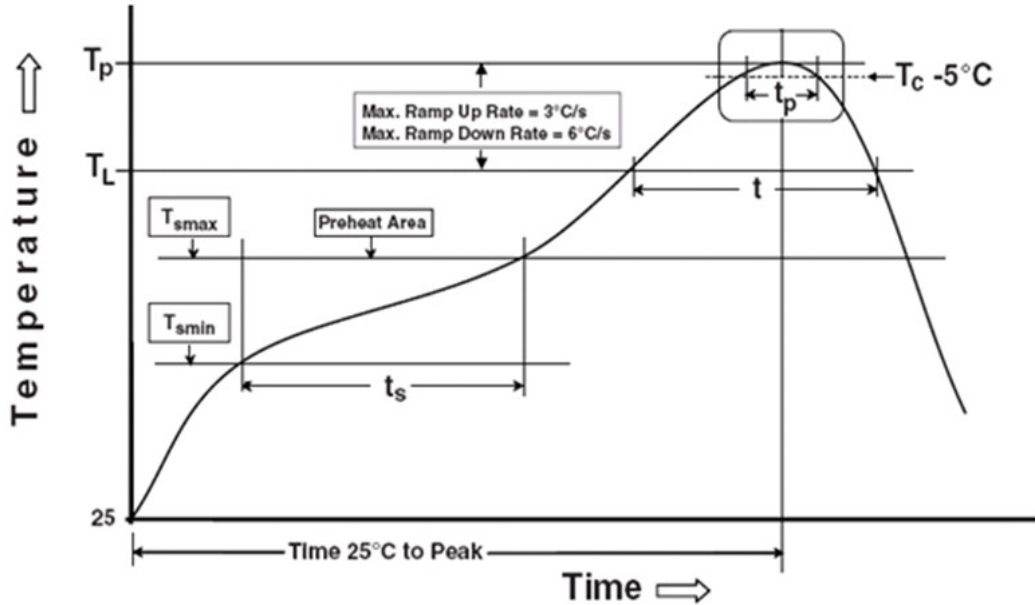

Note:

Reference: IPC/JEDEC J-STD-020D

Preheat

| | |
|--|------------------|
| Temperature min (T_{smin}) | 150 °C |
| Temperature max (T_{smax}) | 200 °C |
| Time (T_{smin} to T_{smax}) (t_s) | 60-120 seconds |
| Average ramp-up rate (T_{smax} to T_p) | 3 °C/second max. |

Other

| | |
|--|------------------|
| Liquidus Temperature (T_L) | 217 °C |
| Time above Liquidus Temperature (t_L) | 60-150 seconds |
| Peak Temperature (T_p) | 260 °C |
| Time within 5 °C of Actual Peak Temperature: $T_p - 5^\circ\text{C}$ | 30 seconds |
| Ramp- Down Rate from Peak Temperature | 6 °C/second max. |
| Time 25°C to peak temperature | 8 minutes max. |
| Reflow times | 1 time |

All parameters are maximum body case temperature values and cannot be considered as a soldering profile. The body case temperature was measured by soldering a thermal couple to the soldering point of LEDs.

1.2 (B) Recommend soldering pad

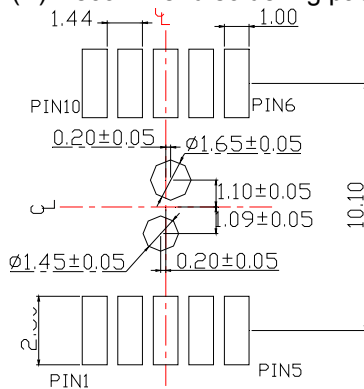

Application Restrictions

1. Specification described in this document. Above specification may be changed without notice. EVERLIGHT will reserve authority on material change for above specification.
2. When using this product, please observe the absolute maximum ratings and the instructions for using outlined in these specification sheets. EVERLIGHT assumes no responsibility for any damage resulting from use of the product which does not comply with the absolute maximum ratings and the instructions included in these specification sheets.
3. These specification sheets include materials protected under copyright of EVERLIGHT Corporation. Please don't reproduce or cause anyone to reproduce them without EVERLIGHT's consent.
4. ESD (Electrostatic Discharge)
 - The products are sensitive to static electricity or surge voltage. ESD can damage a die and its reliability. When handling the products, the following measures against electrostatic discharge are strongly recommended:
 - Eliminating the charge
 - Grounded wrist strap, ESD footwear, clothes, and floors
 - Grounded workstation equipment and tools
 - ESD table/shelf mat made of conductive materials
 - Proper grounding is required for all devices, equipment, and machinery used in product assembly. Surge protection should be considered when designing of commercial products.
 - If tools or equipment contain insulating materials such as glass or plastic, the following measures against electrostatic discharge are strongly recommended:
 - Dissipating static charge with conductive materials
 - Preventing charge generation with moisture
 - Neutralizing the charge with ionizers
5. The LEDs should be operated with forward bias. The driving circuit must be designed so that the LEDs are not subjected to forward or reverse voltage while it is off. If reverse voltage is continuously applied to the LEDs, it may cause migration resulting in LED damage.