

Relay socket base PRS, for miniature power relay with 2 CO contacts, Screw connection, Plug-in option for input/suppression modules, Mounting type: Mounting rail TS 35

RAL: 9005

Kaufmännische Daten

Artikelnummer	<u>15136.2</u>
Artikelbezeichnung	PRS 2
GTIN (EAN)	4044211046194
Packaging unit	1
Quantity unit	PC
Weight per piece (not including packaging)	34.7 g
Weight per piece (including packaging)	38.62 g
Unit of weight	G
Customs number	85366990
Country of origin	CN
Product description	Relay socket base with screw connection
Colour	Black

Technische Daten

Dimensions

Length	76 mm
Width	15.7 mm
Height TS 35 / 7.5 with BA	46 mm

Ratings

Overvoltage category	III
Contamination degree	2

Connection data

Connection principle	Screw connection
Wire cross-section single core (rigid), min.	0.2 mm ²
Wire cross-section single-core (rigid), max.	2.5 mm ²
Wire cross-section stranded, min.	0.2 mm ²
Wire cross-section stranded, max.	2.5 mm ²
Wire cross-section stranded with wire-end ferrules, min.	0.2 mm ²
Wire cross-section stranded with wire-end ferrules, max.	1.5 mm ²
Stripping length	8 mm
Torque	0.8 Nm

Output data

Switching voltage / switching voltage max.	230 / 400 VAC
Continuous current max. / Inrush current max.	10 A
Contact configuration	2 CO contacts

Materials

Flammability class UL 94	V-0
Working temperature, min.	-25 °C
Working temperature, max.	80 °C

Further technical data

Degree of protection	IP20
Insulation voltage coil/contact	4 kV
Insulation voltage contact/contact	1 kV
Pinning	5 mm

Technische Daten

Environmental Product Compliance

REACH Conform	yes
REACH Reference date	2023-06-14
REACH Candidate Substance Note	No
RoHS Conform	yes

Zulassungen

Standards and regulations

CE compliant	yes
--------------	-----

Medien

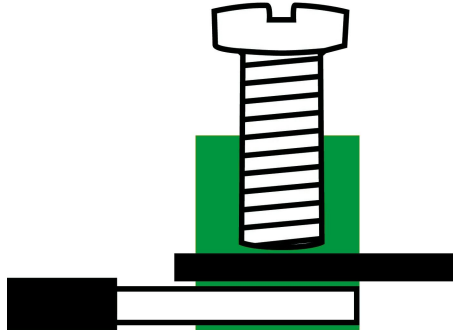
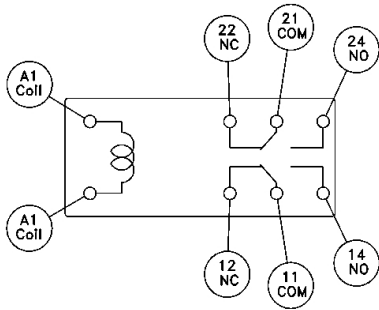

Zubehör

Holding clamp



Relay holding clip, With eject, Suitable for relay socket base PRS 1 and PRS 2, for miniature power relays

Artikelnummer	Artikelbezeichnung	GTIN (EAN)	VPE
<u>15138.2</u>	PRS C1/2	4044211046217	1 ST



Relay holding clip, With eject, Suitable for relay socket base PRS 1 and PRS 2, for industrial relay XT

Artikelnummer	Artikelbezeichnung	GTIN (EAN)	VPE
<u>16016.2</u>	PRSXT C1/2	4044211145217	20 ST

Insert modules



Insertion module, Suitable for relay socket base PRS, LED red status display, With free-wheel diode

Artikelnummer	Artikelbezeichnung	GTIN (EAN)	VPE
<u>15141.2</u>	PRS LED(RD) 24V DC	4044211046231	1 ST



Insertion module, Suitable for relay socket base PRS, LED red status display

Artikelnummer	Artikelbezeichnung	GTIN (EAN)	VPE
<u>15142.2</u>	PRS LED(RD) 230V AC	4044211046255	1 ST



Insertion module, Suitable for relay socket base PRS, LED red status display

Artikelnummer	Artikelbezeichnung	GTIN (EAN)	VPE
<u>15175.2</u>	PRS LED(RD) 24V UC	4044211046521	1 ST



Insertion module, Suitable for relay socket base PRS, LED red status display, With free-wheel diode

Artikelnummer	Artikelbezeichnung	GTIN (EAN)	VPE
<u>15422.2</u>	PRS LED(RD)/110V DC	4044211104306	1 ST

Insert modules

Plug-in module, Suitable for relay socket base PRS, RC element, Input voltage: 24 VAC

Artikelnummer	Artikelbezeichnung	GTIN (EAN)	VPE
<u>15808.2</u>	PRS RC 24V AC	4044211135201	1 ST

Plug-in module, Suitable for relay socket base PRS, RC element, Input voltage: 240 VAC

Artikelnummer	Artikelbezeichnung	GTIN (EAN)	VPE
<u>15809.2</u>	PRS RC 240V AC	4044211135218	1 ST



Insertion module, Suitable for relay socket base PRS, LED red status display, With varistor

Artikelnummer	Artikelbezeichnung	GTIN (EAN)	VPE
<u>15810.2</u>	PRS LED(RD) 230V UC Var.	4044211135225	1 ST



Insertion module, Suitable for relay socket base PRS, LED red status display, With varistor

Artikelnummer	Artikelbezeichnung	GTIN (EAN)	VPE
<u>16070.2</u>	PRS LED(GN) 24V UC Var.	4044211146078	1 ST

Cross-connector



External cross-connector insulated, for relay socket base PRS 1 and PRS 2/6-pole, can be shortened, Voltage: 250 V, Current 10 A

Artikelnummer	Artikelbezeichnung	GTIN (EAN)	VPE
<u>15779.2</u>	AQI/PRS/8 BK	4044211134006	20 ST

Screwdriver



Screwdriver with bare blade, Colour: Black-grey

Artikelnummer	Artikelbezeichnung	GTIN (EAN)	VPE
<u>1086.0</u>	SDB 0,6x3,5	4044211014797	1 ST

Relays

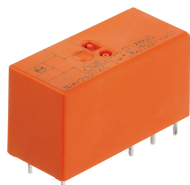

Plug-in miniature power relay, Encapsulated design with power contact, 2 CO contacts, Input voltage: 60 VAC

Artikelnummer	Artikelbezeichnung	GTIN (EAN)	VPE
<u>15335.2</u>	PRS 2/60V DC	4044211047177	1 ST



Plug-in industrial relays with power contacts, 2 CO contacts, Test button, Status LED, Free-wheel diode, Mechanical switching position indicator, Polarity A1+, A2-, Input voltage: 24 VDC

Artikelnummer	Artikelbezeichnung	GTIN (EAN)	VPE
<u>16013.2</u>	PRSXT 2/24V DC	4044211145187	10 ST

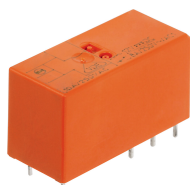

Plug-in miniature power relay, Encapsulated design with power contact, 2 CO contacts, Input voltage: 48 VAC

Artikelnummer	Artikelbezeichnung	GTIN (EAN)	VPE
<u>15334.2</u>	PRS 2/48V DC	4044211047160	1 ST

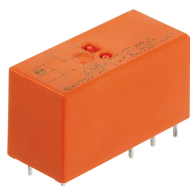

Plug-in miniature power relay, Encapsulated design with power contact, 2 CO contact, Input voltage: 110 VDC

Artikelnummer	Artikelbezeichnung	GTIN (EAN)	VPE
<u>15541.2</u>	PRS 2/110V DC	4044211117924	1 ST



Plug-in industrial relays with power contacts, 2 CO contacts, Test button, Status LED, Mechanical switching position indicator, Input voltage: 24 VAC

Artikelnummer	Artikelbezeichnung	GTIN (EAN)	VPE
<u>16014.2</u>	PRSXT 2/24V AC	4044211145194	10 ST



Plug-in industrial relays with power contacts, 2 CO contacts, Test button, Status LED, Mechanical switching position indicator, Input voltage: 230 VAC

Artikelnummer	Artikelbezeichnung	GTIN (EAN)	VPE
<u>16015.2</u>	PRSXT 2/230V AC	4044211145200	10 ST

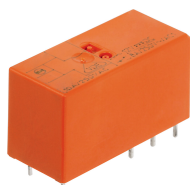

Plug-in miniature power relay, Encapsulated design with power contact, 2 CO contacts, Input voltage: 60 VAC

Artikelnummer	Artikelbezeichnung	GTIN (EAN)	VPE
<u>16124.2</u>	PRS 2/24V DC Au	4044211178222	1 ST

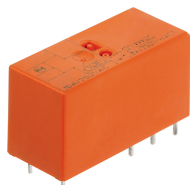

Plug-in miniature power relay, Encapsulated design with power contact, 2 CO contact, Input voltage: 12 VDC

Artikelnummer	Artikelbezeichnung	GTIN (EAN)	VPE
<u>6482.2</u>	PRS 2/12V DC	4044211074210	1 ST

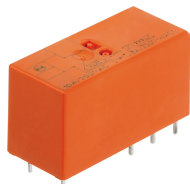

Plug-in miniature power relay, Encapsulated design with power contact, 2 CO contact, Input voltage: 24 VDC

Artikelnummer	Artikelbezeichnung	GTIN (EAN)	VPE
<u>6483.2</u>	PRS 2/24V DC	4044211074227	1 ST

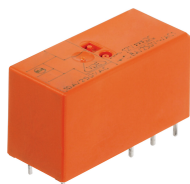

Plug-in miniature power relay, Encapsulated design with power contact, 2 CO contacts, Input voltage: 24 VAC

Artikelnummer	Artikelbezeichnung	GTIN (EAN)	VPE
<u>6484.2</u>	PRS 2/24V AC	4044211074234	1 ST

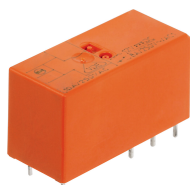

Plug-in miniature power relay, Encapsulated design with power contact, 2 CO contacts, Input voltage: 230 VAC

Artikelnummer	Artikelbezeichnung	GTIN (EAN)	VPE
<u>6485.2</u>	PRS 2/230V AC	4044211074241	1 ST

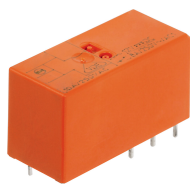

Plug-in miniature power relay, Encapsulated design with power contact, 2 CO contacts, Input voltage: 48 VAC

Artikelnummer	Artikelbezeichnung	GTIN (EAN)	VPE
<u>15947.2</u>	PRS 2/48V AC	4044211141899	10 ST



Plug-in industrial relays with power contacts, 1 CO contact, Test button, Status LED, Mechanical switching position indicator, Input voltage: 230 VAC

Artikelnummer	Artikelbezeichnung	GTIN (EAN)	VPE
<u>16085.2</u>	PRSXT 1/230V AC	4044211171544	10 ST

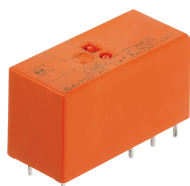

Plug-in miniature power relay, Encapsulated design with power contact, 1 CO contact, Input voltage: 24 VDC

Artikelnummer	Artikelbezeichnung	GTIN (EAN)	VPE
<u>6940.0</u>	PRS 1L/24V DC	4044211076658	1 ST



Plug-in industrial relays with power contacts, 1 CO contact, Test button, Status LED, Free-wheel diode, Mechanical switching position indicator, Polarity A1+, A2-, Input voltage: 24 VDC

Artikelnummer	Artikelbezeichnung	GTIN (EAN)	VPE
<u>16083.2</u>	PRSXT 1/24V DC	4044211171520	10 ST



Plug-in industrial relays with power contacts, 1 CO contact, Test button, Status LED, Mechanical switching position indicator, Input voltage: 24 VAC

Artikelnummer	Artikelbezeichnung	GTIN (EAN)	VPE
<u>16084.2</u>	PRSXT 1/24V AC	4044211171537	10 ST



Plug-in miniature power relay, Encapsulated design with power contact, 1 CO contact, Input voltage: 24 VDC

Artikelnummer	Artikelbezeichnung	GTIN (EAN)	VPE
<u>6939.0</u>	PRS 1/24VDC-16A	4044211208905	1 ST