

## 200mA High Speed LDO Voltage Regulator with Inrush Current Prevention

### GENERAL DESCRIPTION

The XC6233 series is a 200mA high speed LDO regulator that features high accurate high ripple rejection and low dropout. The series consists of a voltage reference, an error amplifier, a driver transistor, a current limiter, a phase compensation circuit and an inrush current prevention circuit.

The output voltage is selectable in 0.05V increments (Accuracy  $\pm 1\%$ ) within the range of 1.2V to 3.6V.

The CE function enables the circuit to be in stand-by mode as well as the electric charge at the output capacitor  $C_L$  to be discharged via the internal switch, and the  $V_{OUT}$  pin quickly returns to the Low level.

The series is also compatible with low ESR ceramic capacitors, which provides stable output voltage. This stability can be maintained even during load fluctuations due to the excellent transient response.

The over current prevention circuit will operate when the output current reaches the current limit.

### APPLICATIONS

- Mobile devices / terminals
- Modules ( wireless, cameras, etc. )
- Smart phones / Mobile phones

### FEATURES

- Maximum Output Current : 200mA
- Input Voltage Range : 1.7V ~ 5.5V
- Output Voltage Range : 1.2V ~ 3.6V ( $\pm 1\%$ ) 0.05V increments
- Dropout Voltage : 240mV @  $I_{OUT}=200mA$  ( $V_{OUT}=3.0V$ )
- Low Power Consumption : 45  $\mu A$  (TYP.)
- Stand-by Current : 0.1  $\mu A$
- High Ripple Rejection : 75dB@1kHz
- CE Pin Function : Active High  
 $C_L$  Auto Discharge
- Protection Circuit : Current Limit 255mA (TYP.)  
 Short Circuit Protection 60mA (TYP.)
- External Capacitor : Ceramic Capacitor Compatible 1.0  $\mu F$
- Operating Ambient Temperature : -40 ~ +85
- Packages : USP-4  
 SSOT-24  
 SOT-25  
 USPQ-4B04
- Environmentally Friendly : EU RoHS Compliant, Pb Free

### TYPICAL APPLICATION CIRCUIT

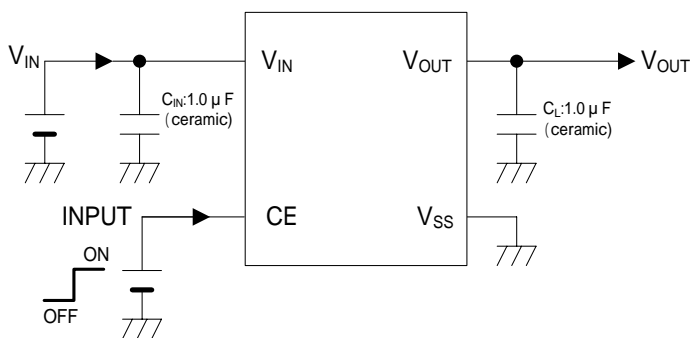

### TYPICAL PERFORMANCE CHARACTERISTICS

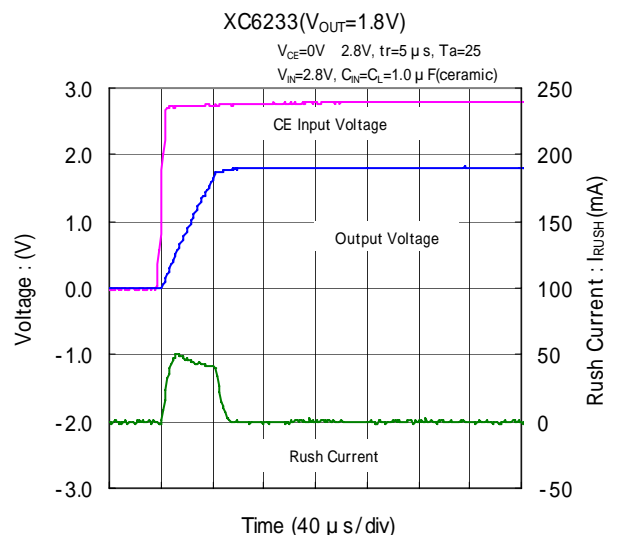

## BLOCK DIAGRAM

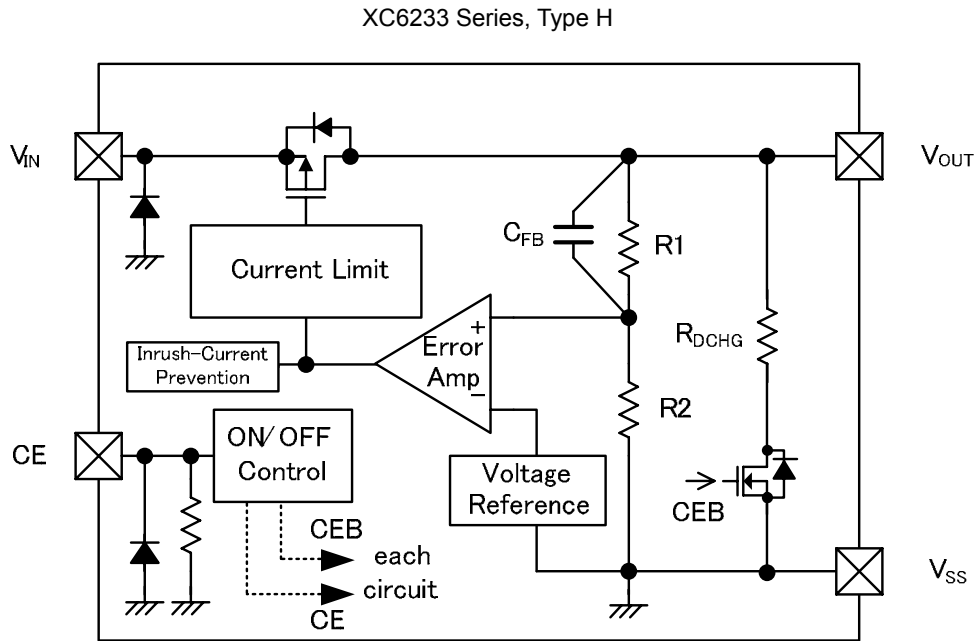

\* Diodes inside the circuits are ESD protection diodes and parasitic diodes.

## PRODUCT CLASSIFICATION

### Ordering Information

XC6233 -

| DESIGNATOR | ITEM                                | SYMBOL  | DESCRIPTION   |
|------------|-------------------------------------|---------|---|
|            | Type of Regulator<br>CE Active High | H       | Refer to Function Guide   |
|            | Output Voltage                      | 12 ~ 36 | ex.) 2.80V → =2, =8 =please see down below  |
|            | Output Voltage<br>Accuracy          | 1       | 0.10V increments,<br>±1% (V <sub>OUT</sub> 2.00V), ±0.02V (V <sub>OUT</sub> < 2.00V)<br>e.g. 2.80V =1 |
|            |                                     | B       | 0.05V increments,<br>±1% (V <sub>OUT</sub> 2.05V), ±0.02V (V <sub>OUT</sub> < 2.05V)<br>e.g. 2.85V =B |
| - (*1)     | Packages<br>(Order Unit)            | 9R-G    | USPQ-4B04 (3000/Reel)   |
|            |                                     | GR-G    | USP-4 (3000/Reel)   |
|            |                                     | NR-G    | SSOT-24 (3000/Reel)   |
|            |                                     | MR-G    | SOT-25 (3000/Reel)  |

(\*1) The "-G" suffix denotes Halogen and Antimony free as well as being fully EU RoHS compliant.

For another type of regulators, please contact your local Torex sales office or representative.

### Function Guide

| TYPE | CURRENT LIMITER | CE PULL-DOWN RESISTOR | C <sub>L</sub> AUTO-DISCHARGE | INRUSH CURRENT PREVENTION |
|------|-----------------|-----------------------|-------------------------------|---------------------------|
| H    | Yes             | Yes                   | Yes                           | Yes                       |

## STANDARD VOLTAGE

### Examples for standard voltage

| V <sub>OUT</sub><br>(V) | PACKAGES       |                |                |                |
|-------------------------|----------------|----------------|----------------|----------------|
|                         | USPQ-4B04      | USP-4          | SSOT-24        | SOT-25         |
| 1.20                    | XC6233H1219R-G | XC6233H121GR-G | XC6233H121NR-G | XC6233H121MR-G |
| 1.50                    | XC6233H1519R-G | XC6233H151GR-G | XC6233H151NR-G | XC6233H151MR-G |
| 1.80                    | XC6233H1819R-G | XC6233H181GR-G | XC6233H181NR-G | XC6233H181MR-G |
| 2.80                    | XC6233H2819R-G | XC6233H281GR-G | XC6233H281NR-G | XC6233H281MR-G |
| 3.30                    | XC6233H3319R-G | XC6233H331GR-G | XC6233H331NR-G | XC6233H331MR-G |

Output voltages can be set internally from 1.2V to 3.6V. For other voltages, please contact your local Torex sales office or representative.

## PIN CONFIGURATION

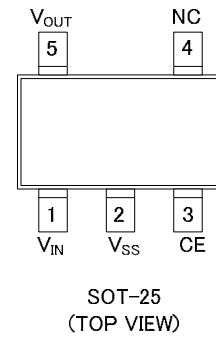
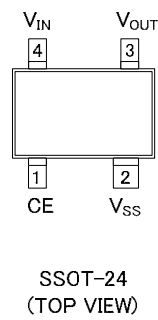
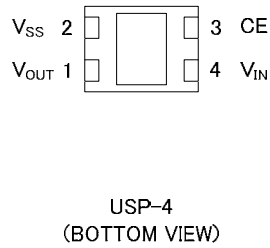
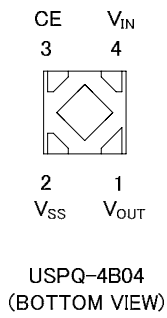

\* The dissipation pad for the USP-4 and USPQ-4B04 packages should be solder-plated in reference mount pattern and metal masking so as to enhance mounting strength and heat release. If the pad needs to be connected to other pins, it should be connected to the  $V_{SS}$  (No. 2) pin.

## PIN ASSIGNMENT

| PIN NUMBER |       |         |        | PIN NAME  | FUNCTIONS          |
|------------|-------|---------|--------|-----------|--------------------|
| USPQ-4B04  | USP-4 | SSOT-24 | SOT-25 |           |                    |
| 1          | 1     | 3       | 5      | $V_{OUT}$ | Output             |
| 2          | 2     | 2       | 2      | $V_{SS}$  | Ground             |
| 3          | 3     | 1       | 3      | CE        | ON/OFF Control     |
| 4          | 4     | 4       | 1      | $V_{IN}$  | Power Supply Input |
| -          | -     | -       | 4      | NC        | No Connection      |

## PIN FUNCTION ASSIGNMENT

| PIN NAME | SIGNAL | STATUS     |
|----------|--------|------------|
| CE       | L      | Stand-by   |
|          | H      | Active     |
|          | OPEN   | Stand-by * |

\* For type H, CE pin voltage is fixed as L level because of internal pull-down resistor.

## ABSOLUTE MAXIMUM RATINGS

Ta=25

| PARAMETER                     |           | SYMBOL           | RATINGS   | UNITS |
|-------------------------------|-----------|------------------|---|-------|
| Input Voltage                 |           | V <sub>IN</sub>  | -0.3 ~ +6.0   | V     |
| Output Current                |           | I <sub>OUT</sub> | 275 <sup>(*)</sup>                                  | mA    |
| Output Voltage                |           | V <sub>OUT</sub> | -0.3 ~ V <sub>IN</sub> +0.3 or +6.0 <sup>(**)</sup> | V     |
| CE Input Voltage              |           | V <sub>CE</sub>  | -0.3 ~ +6.0   | V     |
| Power Dissipation             | USPQ-4B04 | Pd               | 550 (PCB mounted) <sup>(***)</sup>                  | mW    |
|                               | USP-4     |                  | 1000 (PCB mounted) <sup>(***)</sup>                 |       |
|                               | SSOT-24   |                  | 500 (PCB mounted) <sup>(***)</sup>                  |       |
|                               | SOT-25    |                  | 600 (PCB mounted) <sup>(***)</sup>                  |       |
| Operating Ambient Temperature |           | Topr             | -40 ~ +85   |       |
| Storage Temperature           |           | Tstg             | -55 ~ +125  |       |

All voltages are described based on the V<sub>SS</sub>.

(\*) Please use within the range of I<sub>OUT</sub> Pd/(V<sub>IN</sub>-V<sub>OUT</sub>)

(\*\*) The maximum rating corresponds to the lowest value between V<sub>IN</sub>+0.3 or +6.0.

(\*\*\*) This is a reference data taken by using the test board. Please refer to page 26 to 29 for details.

## ELECTRICAL CHARACTERISTICS

XC6233 Series

Ta=25

| PARAMETER                                  | SYMBOL  | CONDITIONS  | MIN.                                    | TYP.                        | MAX.                                    | UNITS    | CIRCUIT |
|--|---|---|---|-----------------------------|---|----------|---------|
| Output Voltage                             | $V_{OUT(E)}$ <sup>(1)</sup>                             | $V_{OUT(T)} = 2.0V$   | $V_{OUT(T)} \times 0.99$ <sup>(2)</sup> | $V_{OUT(T)}$ <sup>(2)</sup> | $V_{OUT(T)} \times 1.01$ <sup>(2)</sup> | V        |         |
|  |   |   | "E-0" <sup>(3)</sup>                    |                             |   |          |         |
|  |   | $V_{OUT(T)} < 2.0V$   | $V_{OUT(T)} - 0.02$ <sup>(2)</sup>      | $V_{OUT(T)}$ <sup>(2)</sup> | $V_{OUT(T)} + 0.02$ <sup>(2)</sup>      |          |         |
|  |   |   | "E-0" <sup>(3)</sup>                    |                             |   |          |         |
| Maximum Output Current                     | $I_{OUTMAX}$  | -   | 200                                     | -                           | -                                       | mA       |         |
| Load Regulation                            | $\Delta V_{OUT}$  | 0.1mA $I_{OUT}$ 200mA   | -                                       | 25                          | 45                                      | mV       |         |
| Dropout Voltage                            | $V_{dif}$ <sup>(4)</sup>                                | $I_{OUT} = 200mA$   | -                                       | "E-1" <sup>(5)</sup>        |   | mV       |         |
| Supply Current                             | $I_{DD}$  | $I_{OUT} = 0mA$   | -                                       | 45                          | 87                                      | $\mu A$  |         |
| Stand-by Current                           | $I_{STB}$   | $V_{CE} = V_{SS}$   | -                                       | 0.01                        | 0.10                                    | $\mu A$  |         |
| Line Regulation                            | $\frac{\Delta V_{OUT}}{(\Delta V_{IN} \cdot V_{OUT})}$  | $V_{OUT(T)} < 2.0V, I_{OUT} = 30mA$<br>2.5V $V_{IN}$ 5.5V   | -                                       | 0.02                        | 0.10                                    | %V       |         |
|  |   | $V_{OUT(T)} = 2.0V, I_{OUT} = 30mA$<br>$V_{OUT(T)} + 0.5V$ $V_{IN}$ 5.5V  |   |                             |   |          |         |
|  |   |   |   |                             |   |          |         |
| Input Voltage                              | $V_{IN}$  | -   | 1.7                                     | -                           | 5.5                                     | V        |         |
| Output Voltage Temperature Characteristics | $\frac{\Delta V_{OUT}}{(\Delta T_{opr} \cdot V_{OUT})}$ | $I_{OUT} = 10mA$<br>-40 $T_{opr}$ 85  | -                                       | $\pm 80$                    | -                                       | ppm/     |         |
| Power Supply Rejection Ratio               | PSRR  | $V_{OUT(T)} < 2.5V$<br>$V_{IN} = 3.0V_{DC} + 0.5V_{p-pAC}$<br>$V_{CE} = V_{OUT(T)} + 1.0V$<br>$I_{OUT} = 30mA, f = 1kHz$            | -                                       | 75                          | -                                       | dB       |         |
|  |   | $V_{OUT(T)} = 2.5V$<br>$V_{IN} = \{V_{OUT(T)} + 1.0\} + 0.5V_{p-pAC}$<br>$V_{CE} = V_{OUT(T)} + 1.0V$<br>$I_{OUT} = 30mA, f = 1kHz$ |   |                             |   |          |         |
| Current Limit                              | $I_{LIM}$   | -   | 200                                     | 255                         | -                                       | mA       |         |
| Short Current                              | $I_{SHORT}$   | $V_{OUT} = V_{SS}$  | -                                       | 60                          | -                                       | mA       |         |
| CE "H" Level Voltage                       | $V_{CEH}$   | -   | 0.9                                     | -                           | 5.5                                     | V        |         |
| CE "L" Level Voltage                       | $V_{CEL}$   | -   | $V_{SS}$                                | -                           | 0.3                                     | V        |         |
| CE "H" Level Current (Type H)              | $I_{CEH}$   | $V_{CE} = V_{IN} = 5.5V$  | 2.5                                     | 6.0                         | 9.5                                     | $\mu A$  |         |
| CE "L" Level Current                       | $I_{CEL}$   | $V_{CE} = V_{SS}$   | -0.1                                    | -                           | 0.1                                     | $\mu A$  |         |
| $C_L$ Auto-Discharge Resistance            | $R_{DCHG}$  | $V_{IN} = 5.5V, V_{CE} = V_{SS}, V_{OUT} = 2.0V$  | -                                       | 270                         | -                                       | $\Omega$ |         |
| Inrush Current                             | $I_{RUSH}$  | $V_{IN} = 5.5V, V_{CE} = 0$ 5.5V  | -                                       | 95                          | -                                       | mA       |         |

**NOTE:**

Unless otherwise stated,  $V_{IN} = V_{OUT(T)} + 1V, V_{CE} = V_{IN}, I_{OUT} = 1mA$

<sup>(1)</sup>  $V_{OUT(E)}$  is Effective output voltage

<sup>(2)</sup>  $V_{OUT(T)}$  is Nominal output voltage

<sup>(3)</sup> E-0: OUTPUT VOLTAGE (Refer to the Voltage Chart)

<sup>(4)</sup>  $V_{dif} = \{V_{IN1} - V_{OUT1}\}$

$V_{IN1}$  is the input voltage when  $V_{OUT1}$  appears at the  $V_{OUT}$  pin while input voltage is gradually decreased.

$V_{OUT1}$  is the voltage equal to 98% of the normal output voltage when amply stabilized  $V_{OUT(T)} + 1.0V$  is input at the  $V_{IN}$  pin.

<sup>(5)</sup> E-1: DROPOUT VOLTAGE (Refer to the Voltage Chart)

## ELECTRICAL CHARACTERISTICS (Continued)

Voltage Chart

| NOMINAL<br>OUTPUT<br>VOLTAGE | E-0                      |        | E-1                        |      |
|------------------------------|--------------------------|--------|----------------------------|------|
|                              | OUTPUT<br>VOLTAGE<br>(V) |        | DROPOUT<br>VOLTAGE<br>(mV) |      |
|                              | V <sub>OUT(E)</sub>      |        | V <sub>dif</sub>           |      |
| V <sub>OUT(T)</sub>          | MIN.                     | MAX.   | TYP.                       | MAX. |
| 1.20                         | 1.1800                   | 1.2200 | 680                        | 950  |
| 1.25                         | 1.2300                   | 1.2700 |                            |      |
| 1.30                         | 1.2800                   | 1.3200 | 640                        | 800  |
| 1.35                         | 1.3300                   | 1.3700 |                            |      |
| 1.40                         | 1.3800                   | 1.4200 | 600                        | 695  |
| 1.45                         | 1.4300                   | 1.4700 |                            |      |
| 1.50                         | 1.4800                   | 1.5200 |                            |      |
| 1.55                         | 1.5300                   | 1.5700 |                            |      |
| 1.60                         | 1.5800                   | 1.6200 | 510                        | 630  |
| 1.65                         | 1.6300                   | 1.6700 |                            |      |
| 1.70                         | 1.6800                   | 1.7200 |                            |      |
| 1.75                         | 1.7300                   | 1.7700 | 400                        | 600  |
| 1.80                         | 1.7800                   | 1.8200 |                            |      |
| 1.85                         | 1.8300                   | 1.8700 |                            |      |
| 1.90                         | 1.8800                   | 1.9200 |                            |      |
| 1.95                         | 1.9300                   | 1.9700 | 375                        | 520  |
| 2.00                         | 1.9800                   | 2.0200 |                            |      |
| 2.05                         | 2.0295                   | 2.0705 |                            |      |
| 2.10                         | 2.0790                   | 2.1210 |                            |      |
| 2.15                         | 2.1285                   | 2.1715 |                            |      |
| 2.20                         | 2.1780                   | 2.2220 |                            |      |
| 2.25                         | 2.2275                   | 2.2725 |                            |      |
| 2.30                         | 2.2770                   | 2.3230 |                            |      |
| 2.35                         | 2.3265                   | 2.3735 | 240                        | 380  |
| 2.40                         | 2.3760                   | 2.4240 |                            |      |
| 2.45                         | 2.4255                   | 2.4745 |                            |      |

| NOMINAL<br>OUTPUT<br>VOLTAGE | E-0                      |        | E-1                        |      |
|------------------------------|--------------------------|--------|----------------------------|------|
|                              | OUTPUT<br>VOLTAGE<br>(V) |        | DROPOUT<br>VOLTAGE<br>(mV) |      |
|                              | V <sub>OUT(E)</sub>      |        | V <sub>dif</sub>           |      |
| V <sub>OUT(T)</sub>          | MIN.                     | MAX.   | TYP.                       | MAX. |
| 2.50                         | 2.4750                   | 2.5250 | 310                        | 420  |
| 2.55                         | 2.5245                   | 2.5755 |                            |      |
| 2.60                         | 2.5740                   | 2.6260 |                            |      |
| 2.65                         | 2.6235                   | 2.6765 |                            |      |
| 2.70                         | 2.6730                   | 2.7270 |                            |      |
| 2.75                         | 2.7225                   | 2.7775 |                            |      |
| 2.80                         | 2.7720                   | 2.8280 |                            |      |
| 2.85                         | 2.8215                   | 2.8785 |                            |      |
| 2.90                         | 2.8710                   | 2.9290 |                            |      |
| 2.95                         | 2.9205                   | 2.9795 |                            |      |
| 3.00                         | 2.9700                   | 3.0300 | 240                        | 380  |
| 3.05                         | 3.0195                   | 3.0805 |                            |      |
| 3.10                         | 3.0690                   | 3.1310 |                            |      |
| 3.15                         | 3.1185                   | 3.1815 |                            |      |
| 3.20                         | 3.1680                   | 3.2320 |                            |      |
| 3.25                         | 3.2175                   | 3.2825 |                            |      |
| 3.30                         | 3.2670                   | 3.3330 |                            |      |
| 3.35                         | 3.3165                   | 3.3835 |                            |      |
| 3.40                         | 3.3660                   | 3.4340 |                            |      |
| 3.45                         | 3.4155                   | 3.4845 |                            |      |
| 3.50                         | 3.4650                   | 3.5350 | 375                        | 520  |
| 3.55                         | 3.5145                   | 3.5855 |                            |      |
| 3.60                         | 3.5640                   | 3.6360 | 310                        | 420  |
|                              |                          |        |                            |      |

## TEST CIRCUITS

$C_{IN}=1.0\ \mu\text{F}$ ,  $C_L=1.0\ \mu\text{F}$

Circuit

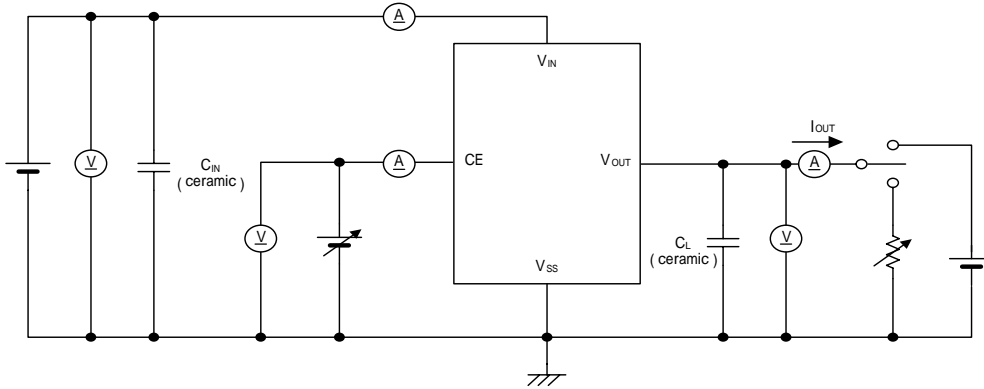

Circuit

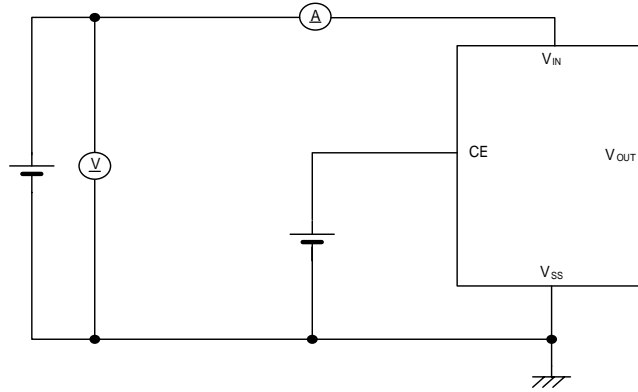

Circuit

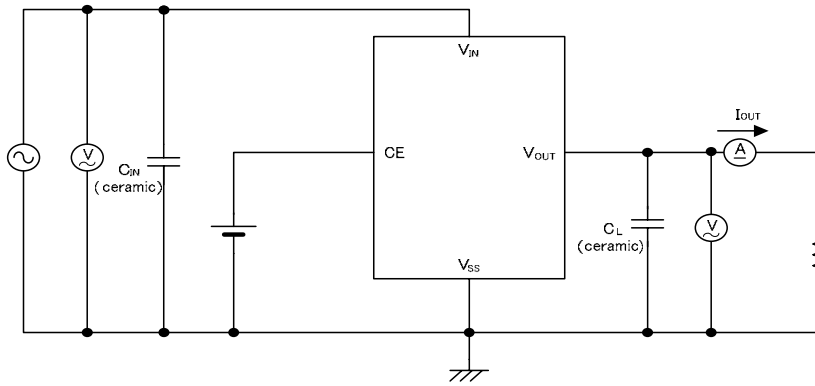

Circuit

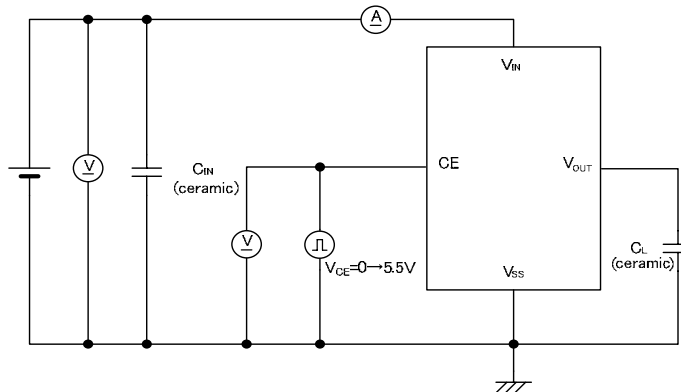



## OPERATIONAL EXPLANATION

The voltage divided by resistors R1 & R2 is compared with the internal reference voltage by the error amplifier. The P-channel MOSFET which is connected to the  $V_{OUT}$  pin is then driven by the subsequent control signal. The output voltage at the  $V_{OUT}$  pin is controlled and stabilized by a system of negative feedback.

The current limit circuit and short circuit protection operate in relation to the level of output voltage and output current.

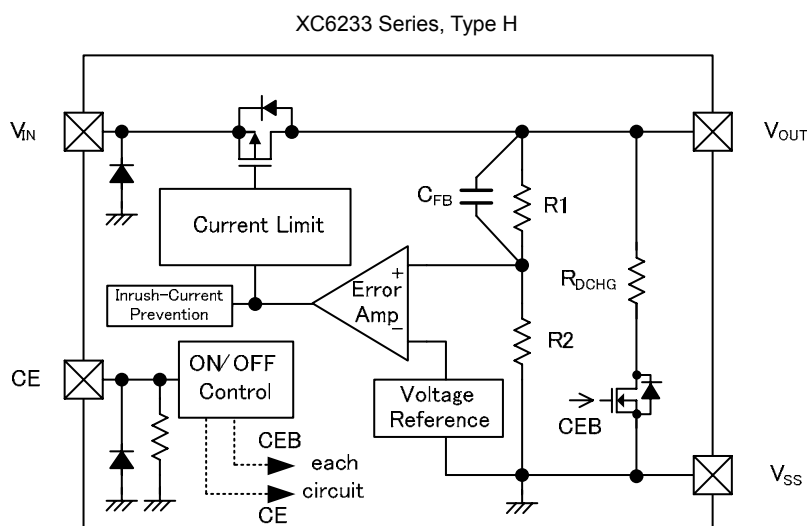

### < Low ESR Capacitor >

The XC6233 series needs an output capacitor ( $C_L$ ) for phase compensation. In order to ensure the stable phase compensation, please place an output capacitor of  $1.0 \mu\text{F}$  at the  $V_{OUT}$  pin and  $V_{SS}$  pin as close as possible. For a stable power input, please connect an input capacitor ( $C_{IN}$ ) of  $1.0 \mu\text{F}$  between the input pin ( $V_{IN}$ ) and the ground pin ( $V_{SS}$ ).

### <Current Limiter, Short-Circuit Protection >

The XC6233 series has current limiter and droop shape of fold-back circuit. When the load current reaches the current limit, the droop current limiter circuit operates and the output voltage drops with keeping the load current. After that, the output voltage drops to a certain level, the fold-back circuit operates and the output current goes to decrease with a degree of output voltage decreasing. The output current finally reaches at the level of 60mA (TYP.) when the output pin is short-circuited.

### <CE Pin>

The IC's internal circuitry can be shutdown via the signal of the CE pin.

The XC6233H series has a pull-down resistor at the CE pin inside. Even the CE pin is left open, the CE pin is fixed as Low level. However, inflow current is generated into the CE pin.

## OPERATIONAL EXPLANATION (Continued)

### <C<sub>L</sub> High-speed Discharge Function>

The N-ch transistor located between the V<sub>OUT</sub> pin and the V<sub>SS</sub> pin and the C<sub>L</sub> discharge resistance is set to 270Ω (TYP.) when V<sub>IN</sub> is 5.5V (TYP.) and V<sub>OUT</sub> is 2.0V (TYP.).

This N-ch transistor can quickly discharge the electric charge at the output capacitor (C<sub>L</sub>), when a low signal is inputted to the CE pin. Moreover, discharge time of the output capacitor (C<sub>L</sub>) is set by the C<sub>L</sub> auto-discharge resistance (R<sub>DCHG</sub>) and the output capacitance (C<sub>L</sub>).

By setting time constant of a C<sub>L</sub> auto-discharge resistance (R<sub>DCHG</sub>) and an output capacitance (C<sub>L</sub>) as  $\tau = C_L \times R_{DCHG}$ , the output voltage after discharge via the N-ch transistor is calculated by the following formula.

$$V = V_{OUT(E)} \times e^{-t/\tau}$$

V: Output voltage after discharge

V<sub>OUT(E)</sub>: Output voltage

t: Discharge time

$\tau$ : R<sub>DCHG</sub> × C<sub>L</sub>

C<sub>L</sub>: Output capacitance

R<sub>DCHG</sub>: C<sub>L</sub> auto-discharge resistance

or discharge time is calculated by the next formula.

$$t = \tau \ln (V_{OUT(E)} / V)$$

### < Inrush Current Prevention >

The inrush current prevention circuit is built in the XC6233 series.

When the IC starts to operate, the prevention circuit limits the inrush current as 95mA (TYP.) from input pin (V<sub>IN</sub>) to output pin (V<sub>OUT</sub>) for charging C<sub>L</sub> capacitor. However, the device can not provide the output current beyond 95mA (TYP.) for a period of approximately 100 μs because internal control of the IC.

## NOTES ON USE

1. For temporary, transitional voltage drop or voltage rising phenomenon, the IC is liable to malfunction should the ratings be exceeded.
2. Where wiring impedance is high, operations may become unstable due to noise and/or phase lag depending on output current. Please strengthen  $V_{IN}$  and  $V_{SS}$  wiring in particular.
3. Please wire the input capacitor ( $C_{IN}$ ) and the output capacitor ( $C_L$ ) as close to the IC as possible.
4. Torex places an importance on improving our products and their reliability.  
We request that users incorporate fail-safe designs and post-aging prevention treatment when using Torex products in their systems.

## TYPICAL PERFORMANCE CHARACTERISTICS

### (1) Output Voltage vs. Output Current

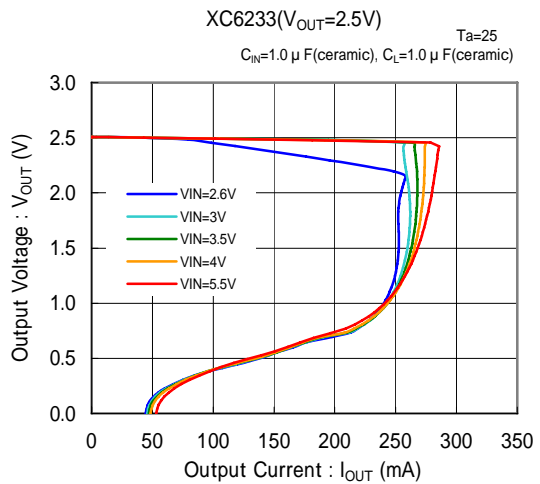
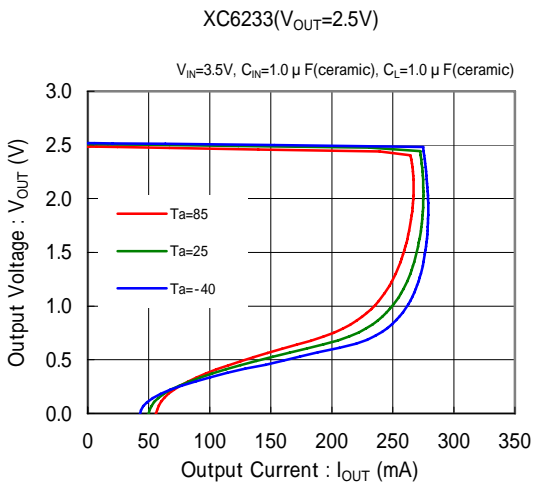
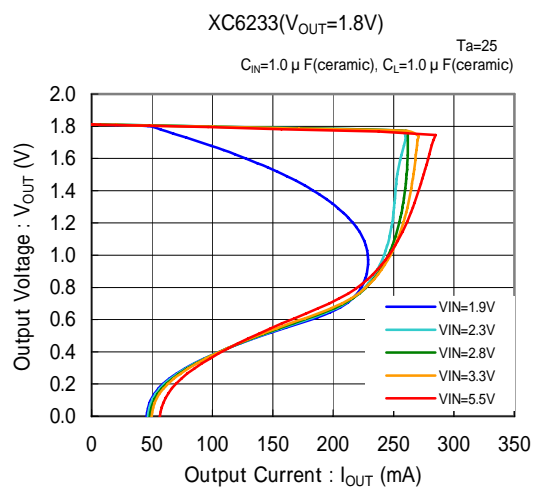
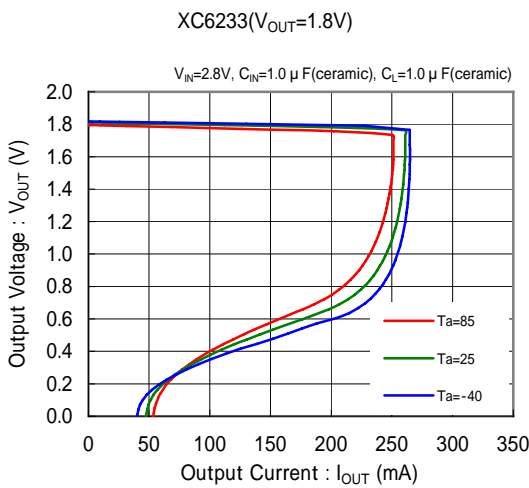
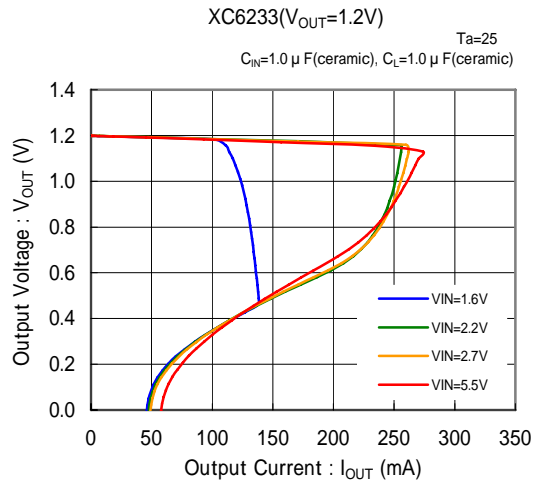
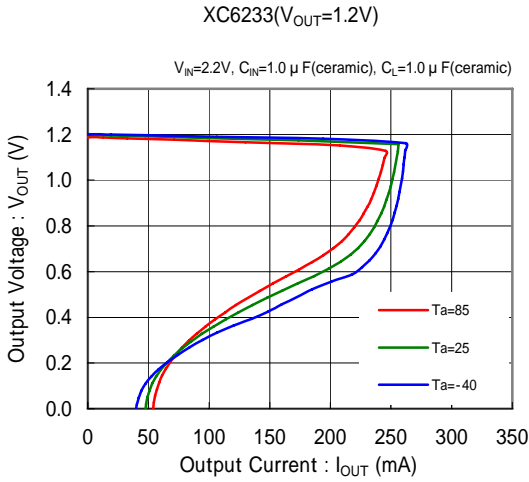

## TYPICAL PERFORMANCE CHARACTERISTICS (Continued)

### (1) Output Voltage vs. Output Current (Continued)

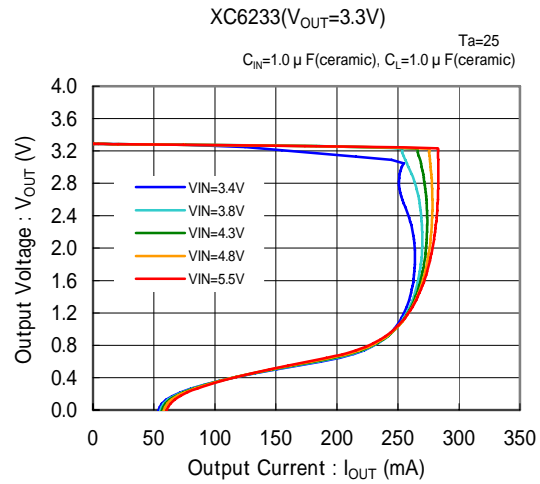
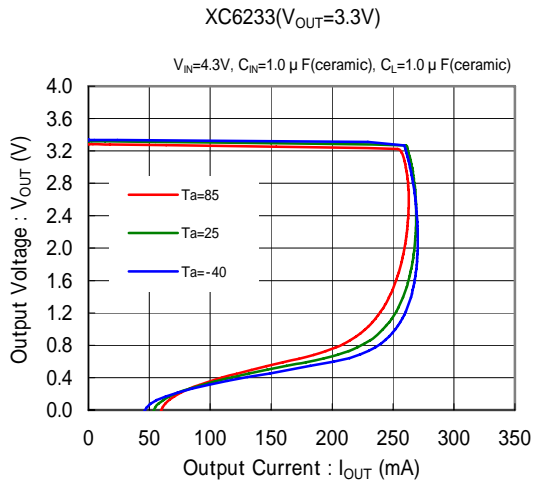

### (2) Output Voltage vs. Input Voltage

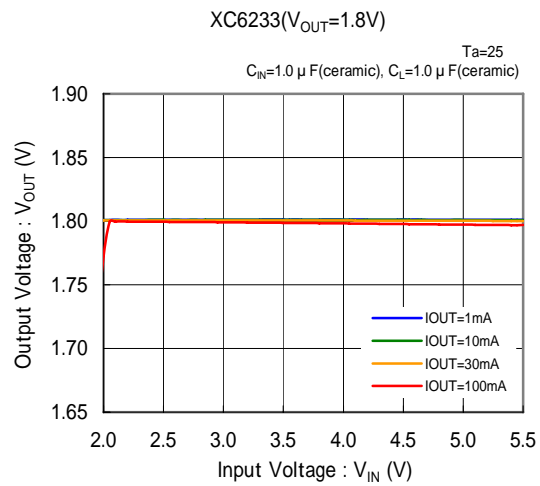
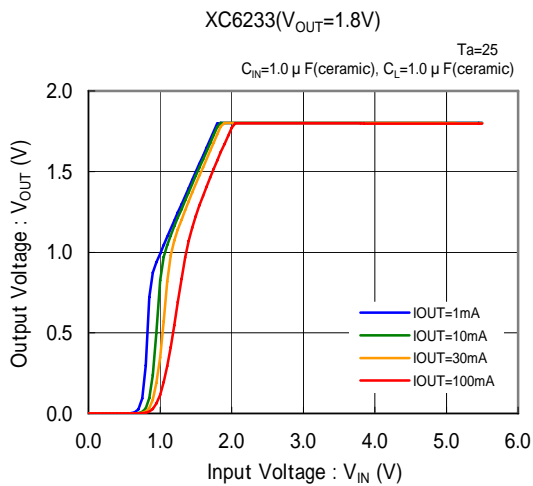
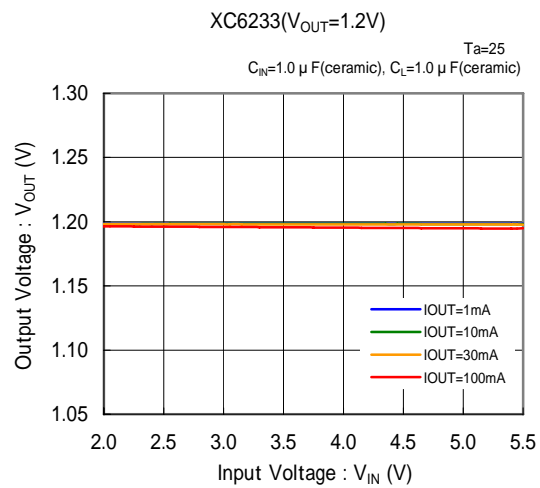
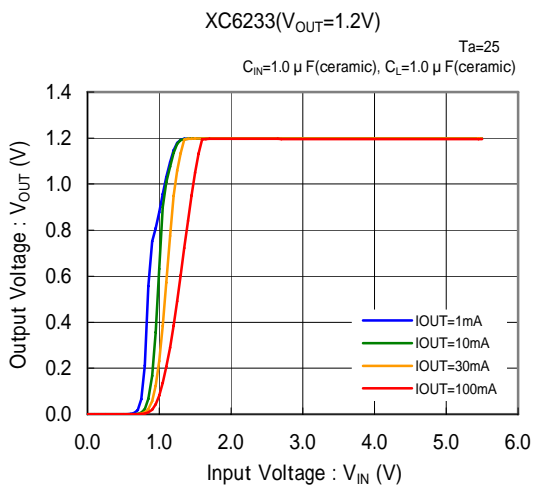

## TYPICAL PERFORMANCE CHARACTERISTICS (Continued)

### (2) Output Voltage vs. Input Voltage (Continued)

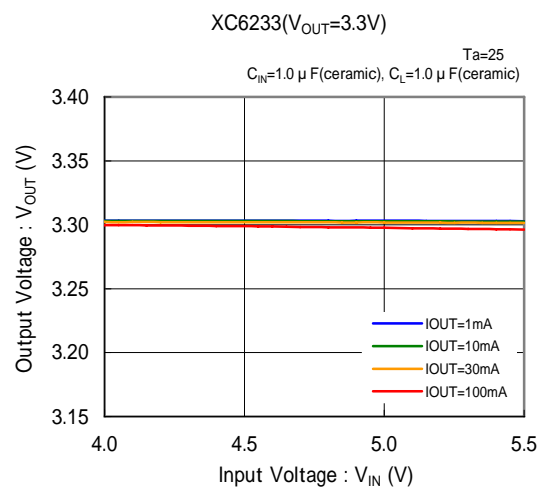
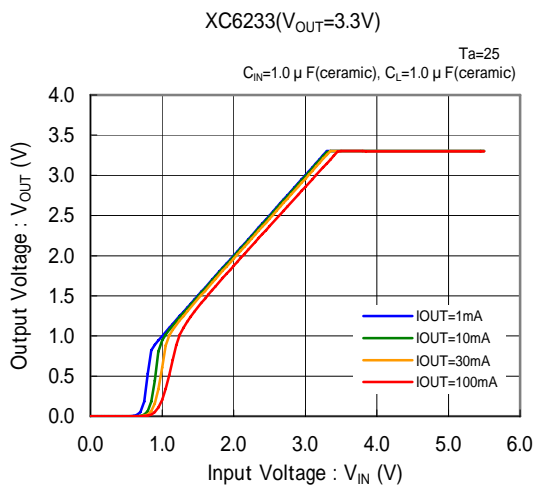
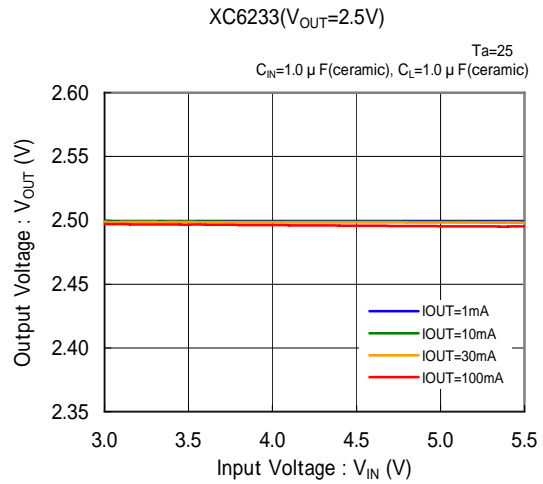
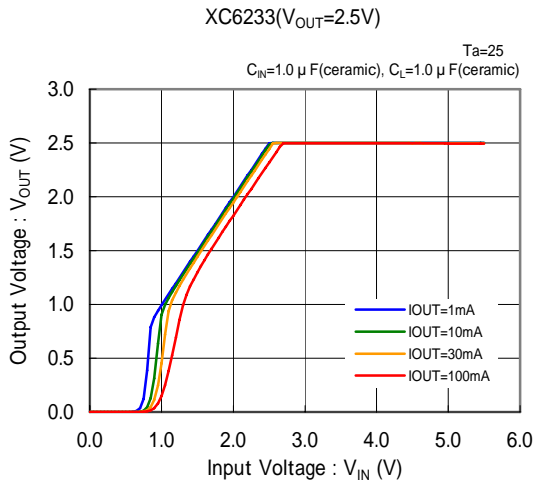

### (3) Dropout Voltage vs. Output Current

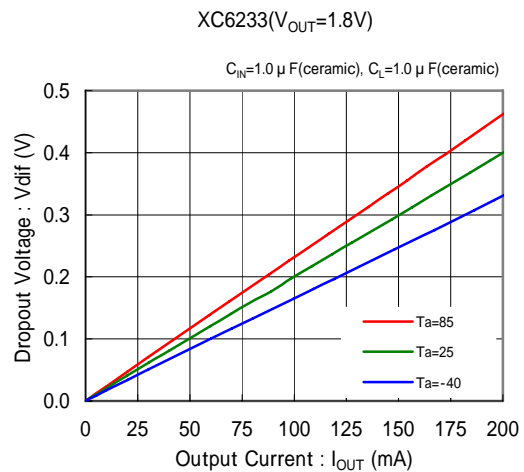
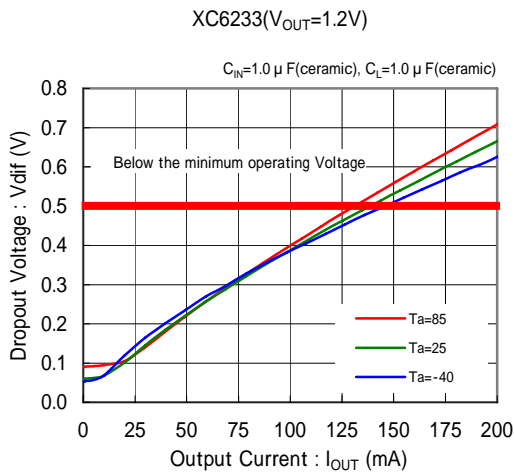

## TYPICAL PERFORMANCE CHARACTERISTICS (Continued)

### (3) Dropout Voltage vs. Output Current (Continued)

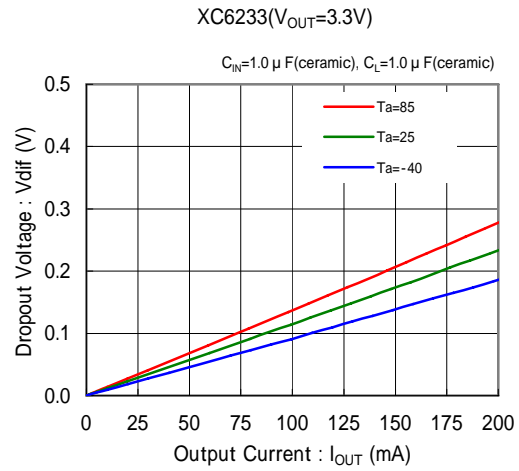
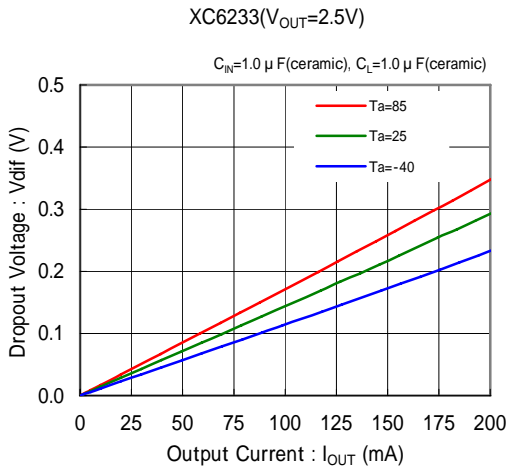

### (4) Supply Current vs. Input Voltage

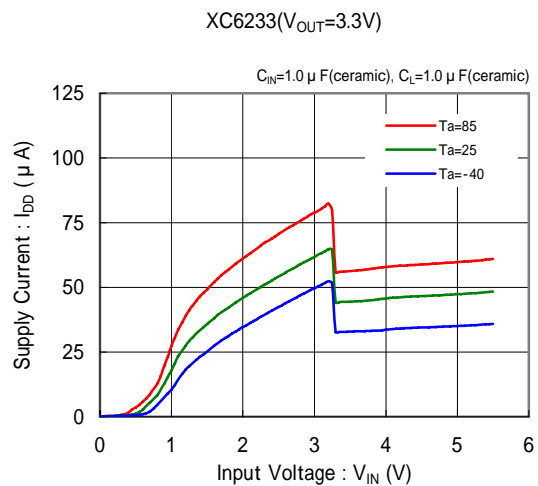
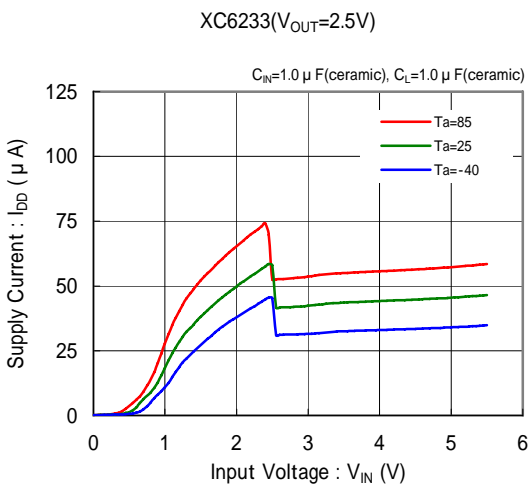
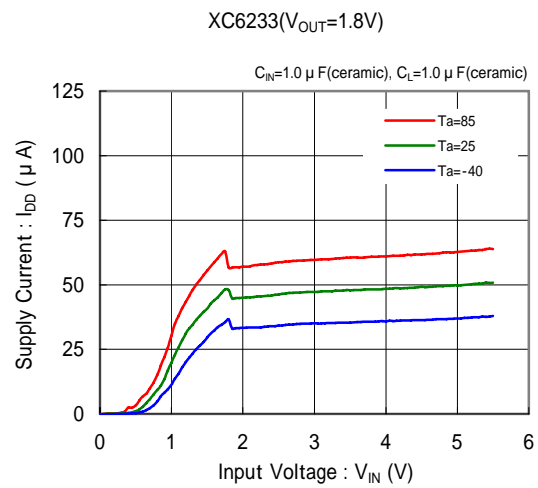
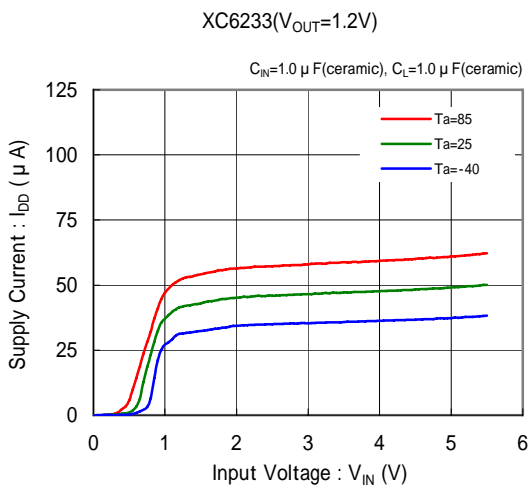

## TYPICAL PERFORMANCE CHARACTERISTICS (Continued)

### (5) Output Voltage vs. Ambient Temperature

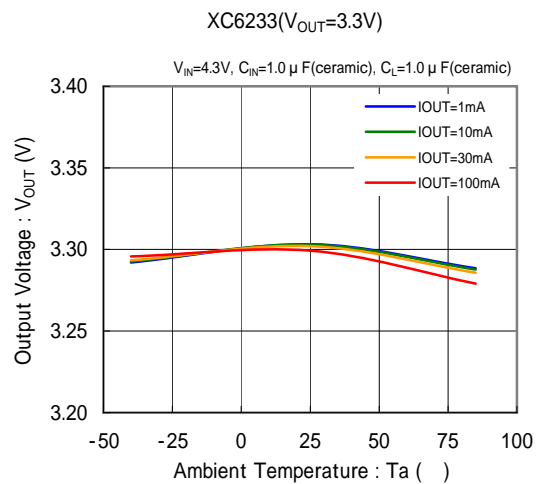
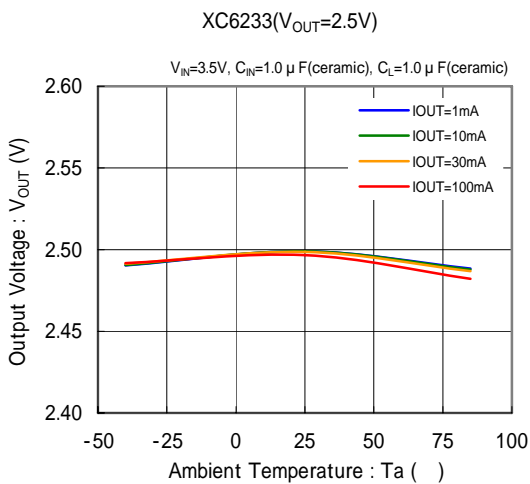
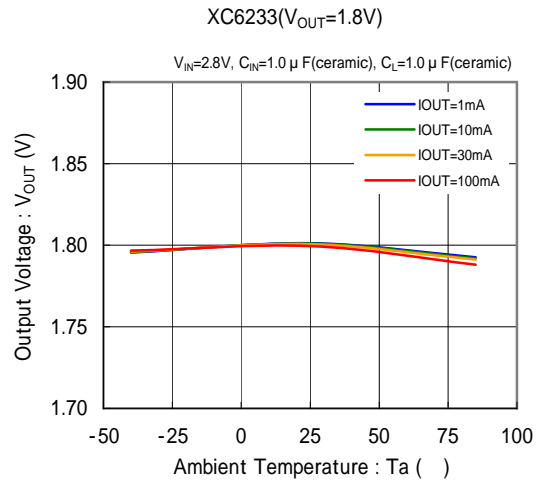
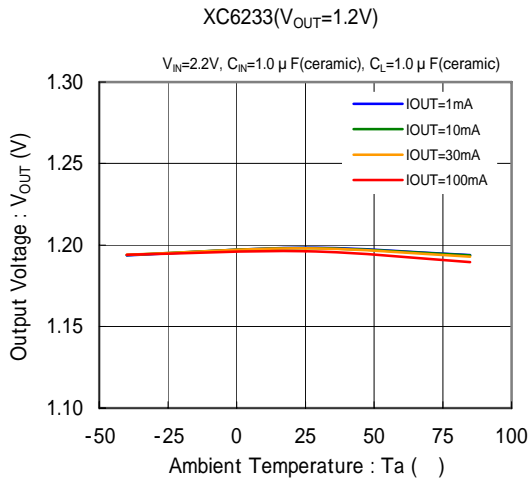

### (6) Supply Current vs. Ambient Temperature

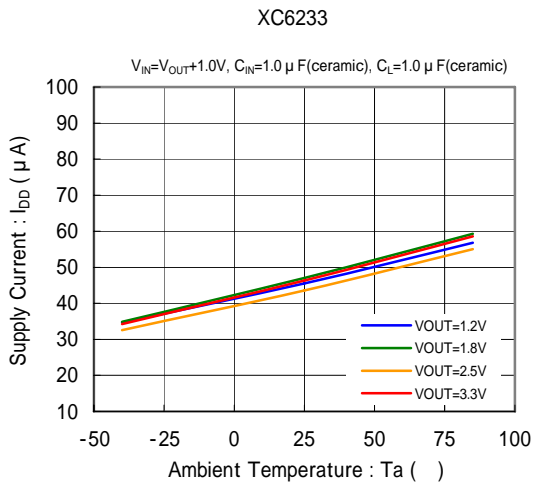

### (7) CE Threshold Voltage vs. Ambient Temperature

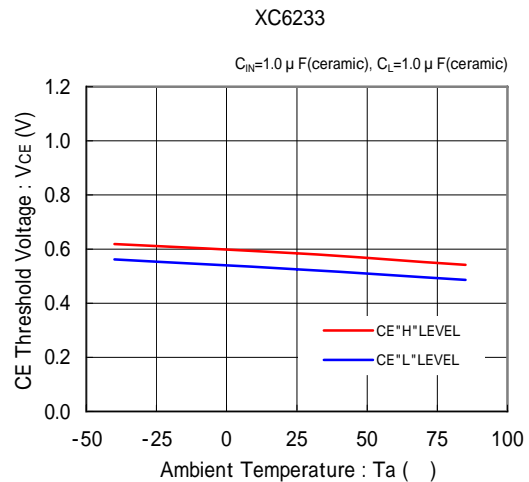



## TYPICAL PERFORMANCE CHARACTERISTICS (Continued)

### (8) Rising Response Time

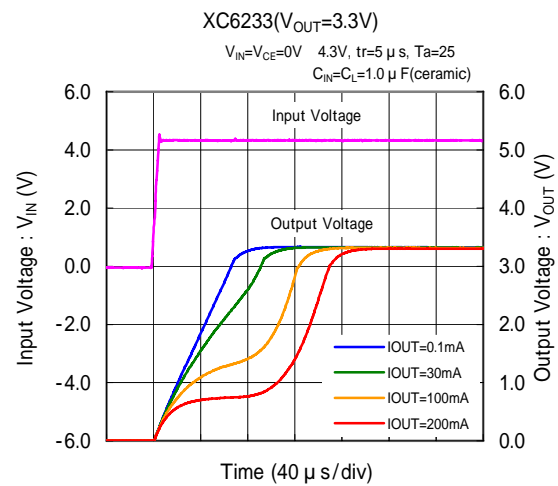
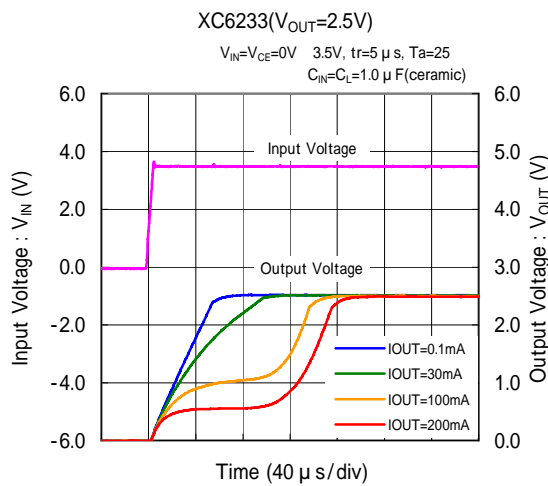
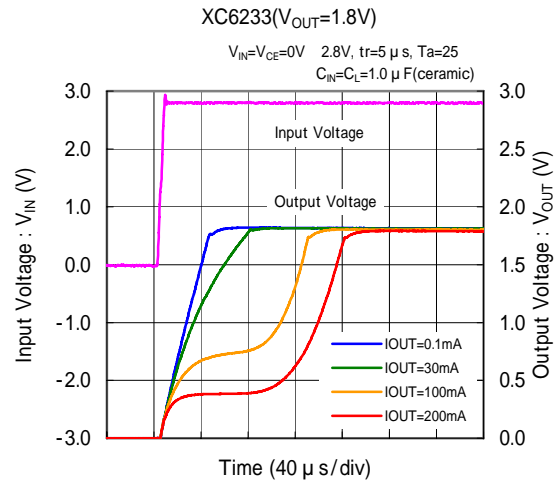
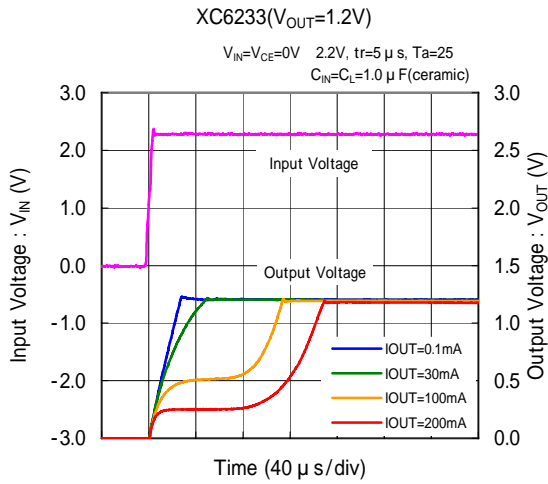

### (9) Input Transient Response

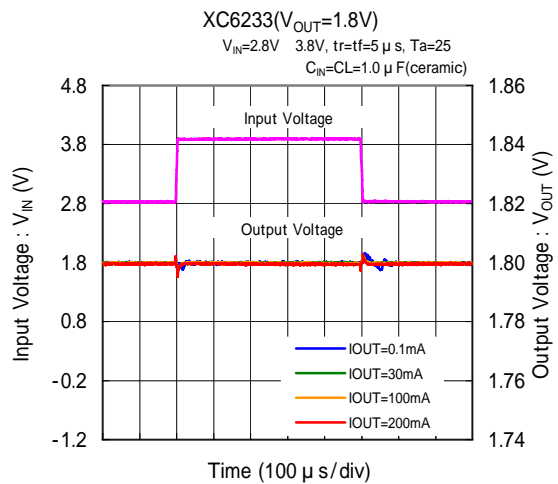
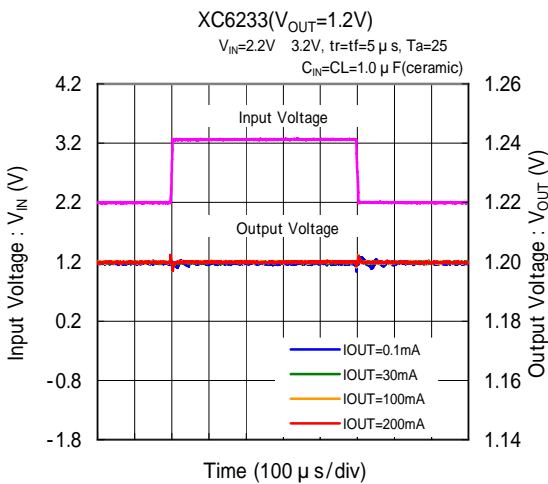

## TYPICAL PERFORMANCE CHARACTERISTICS (Continued)

### (9) Input Transient Response (Continued)

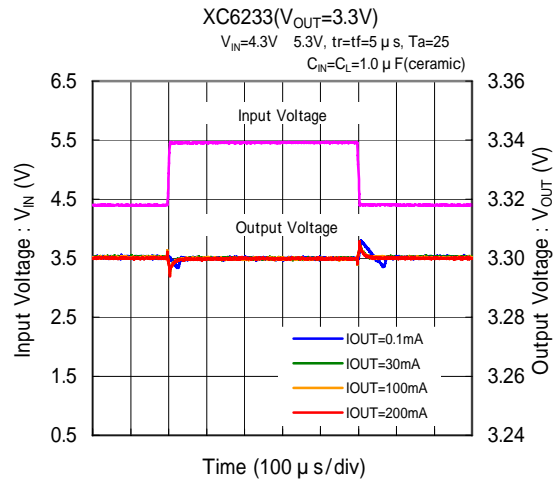
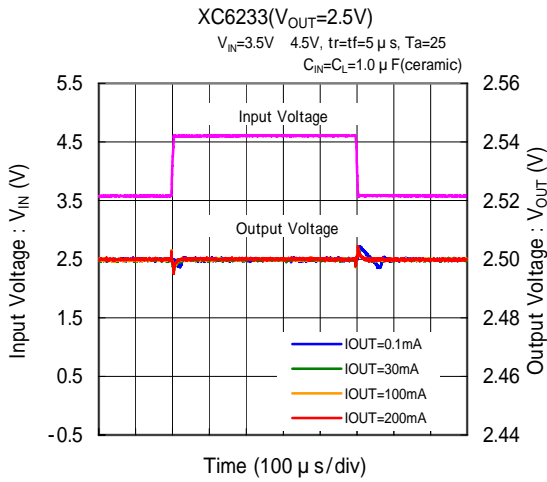

### (10) Load Transient Response

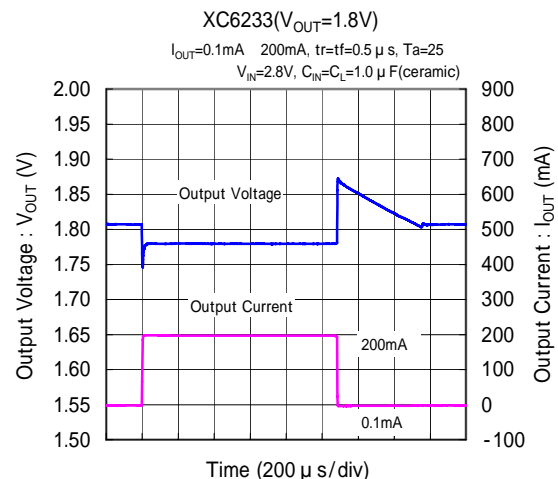
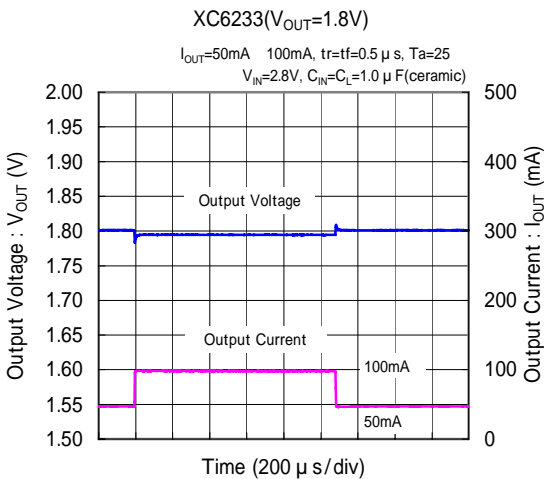
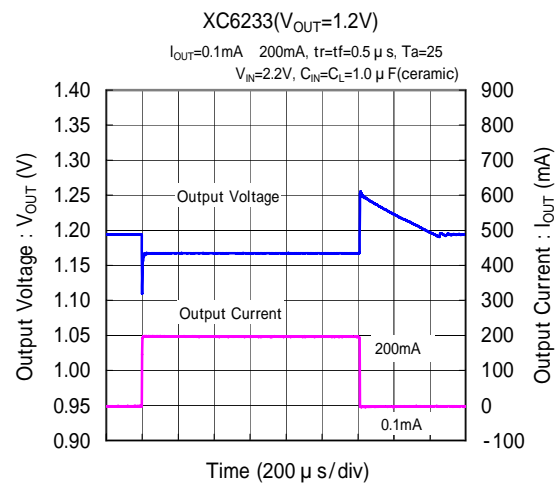
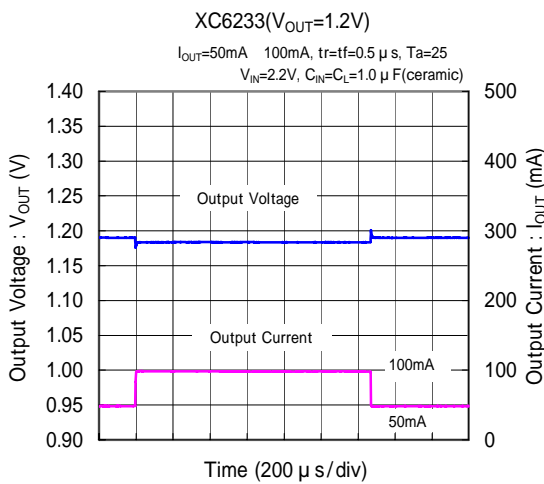

## TYPICAL PERFORMANCE CHARACTERISTICS (Continued)

### (10) Load Transient Response (Continued)

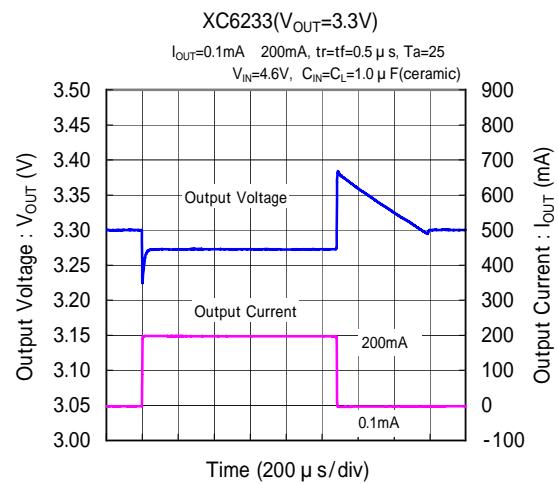
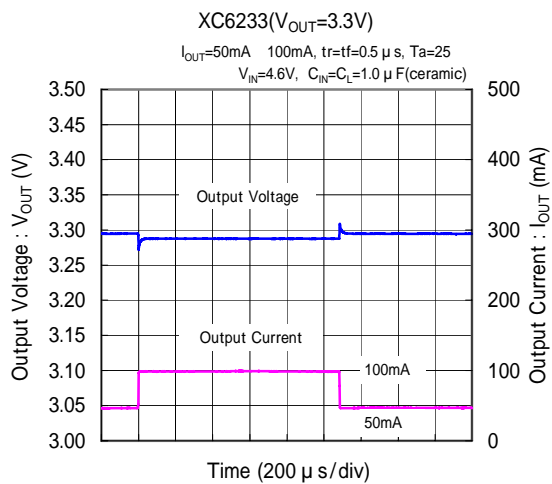
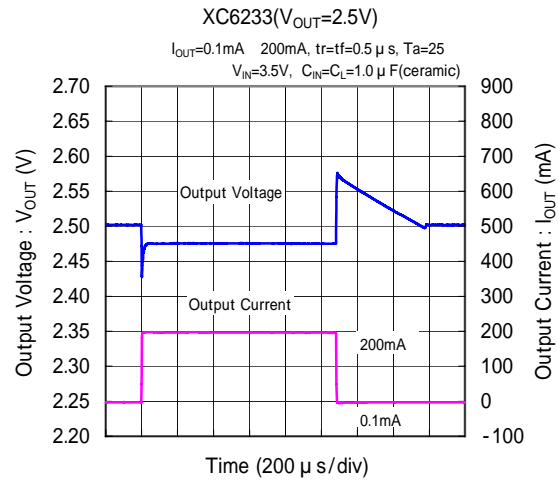
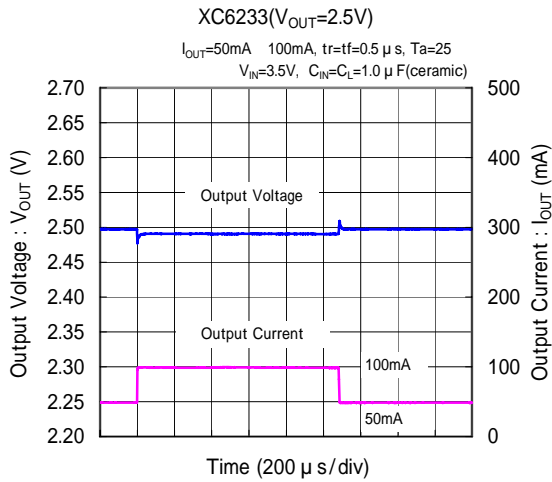

### (11) CE Rising Response Time

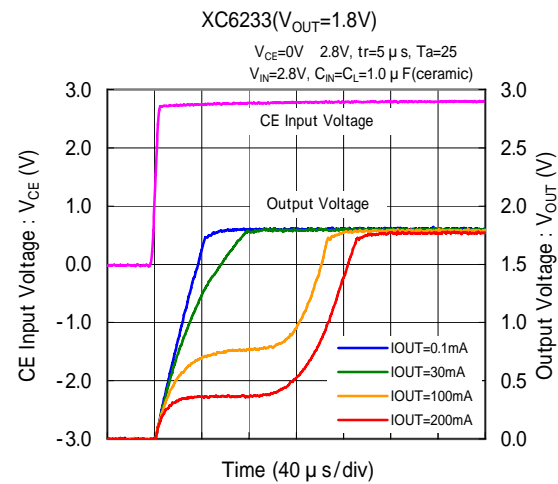
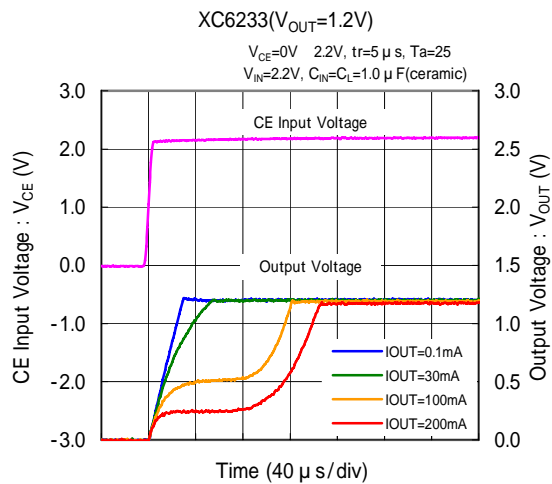

## TYPICAL PERFORMANCE CHARACTERISTICS (Continued)

### (11) CE Rising Response Time (Continued)

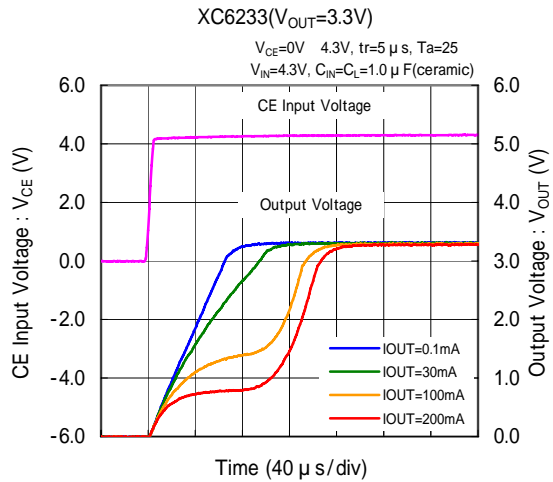
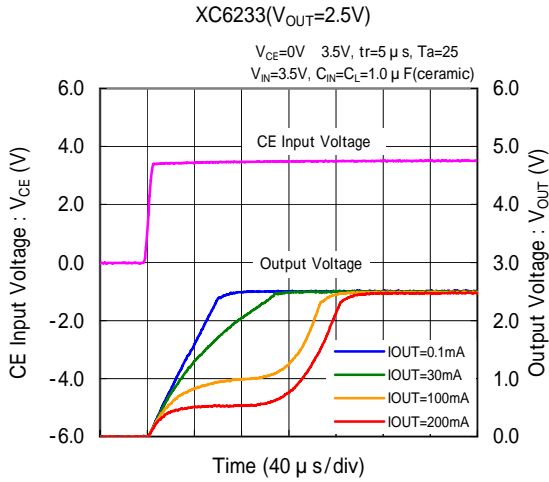

### (12) Power Supply Rejection Ratio

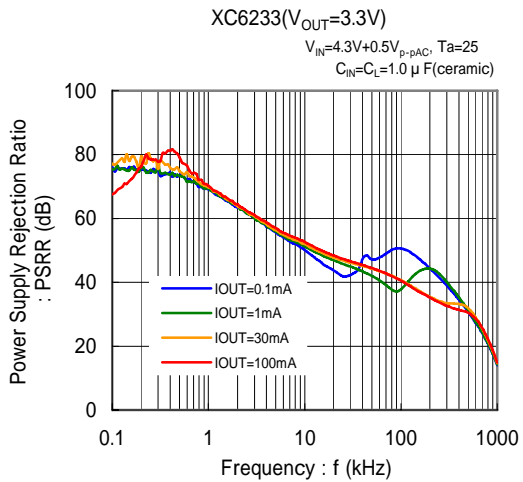
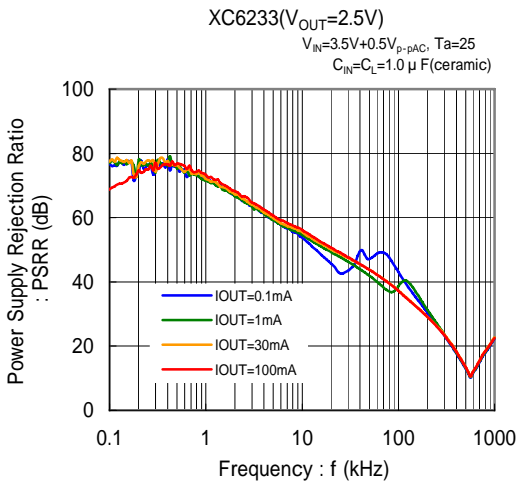
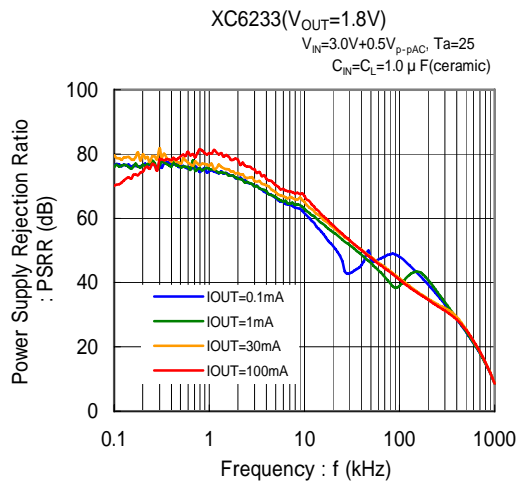
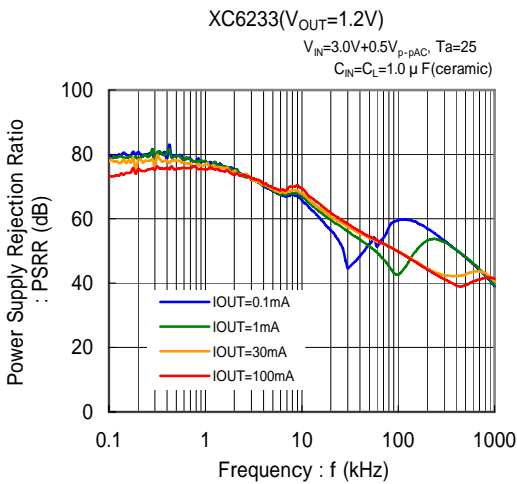

## TYPICAL PERFORMANCE CHARACTERISTICS (Continued)

### (13) Inrush Current Response

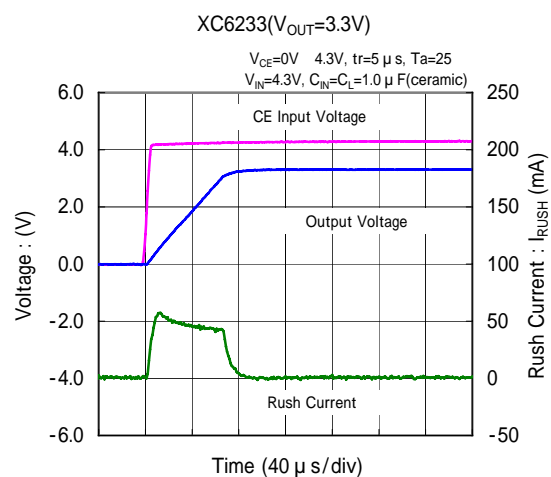
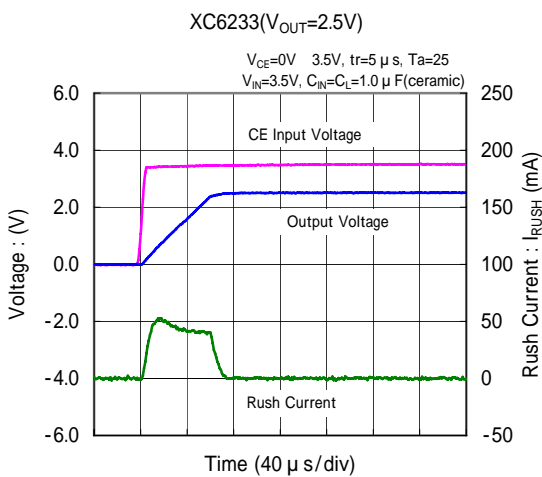
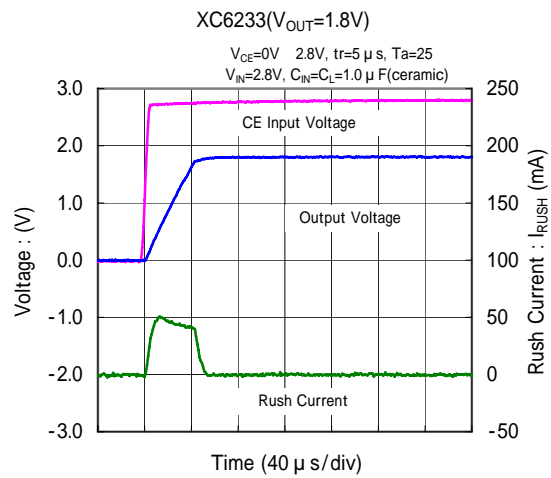
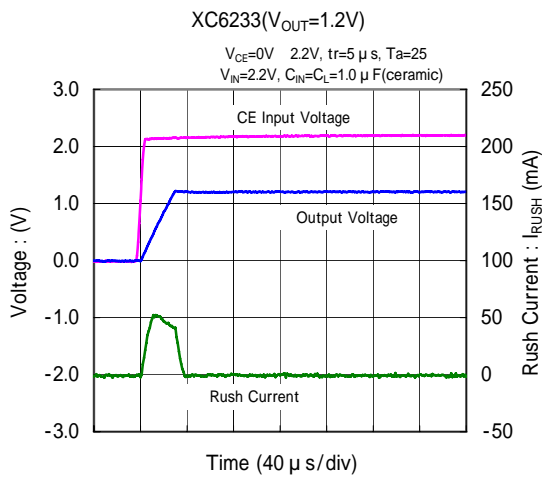

### (14) Output Noise Density

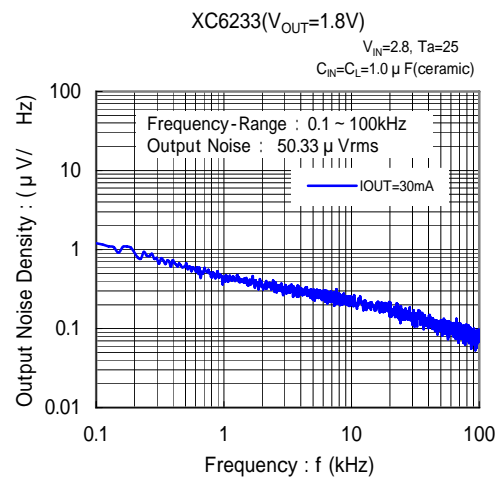
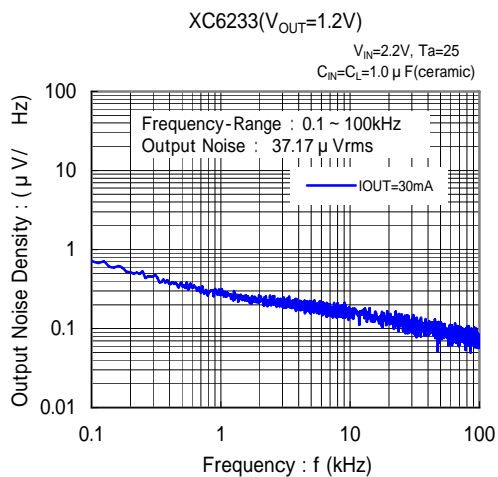

## TYPICAL PERFORMANCE CHARACTERISTICS (Continued)

### (14) Output Noise Density (Continued)

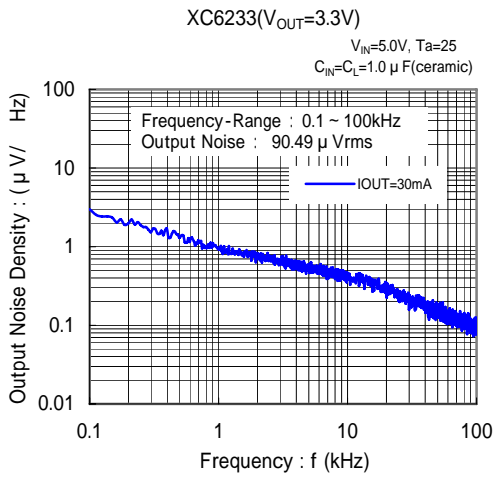

# PACKAGING INFORMATION

● USPQ-4B04 (unit:mm)

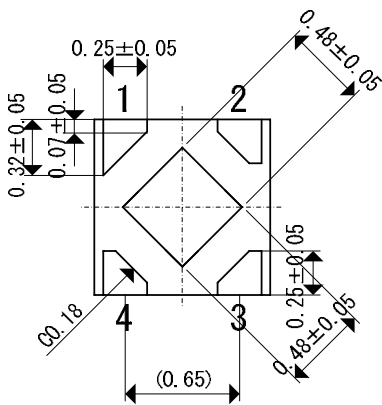
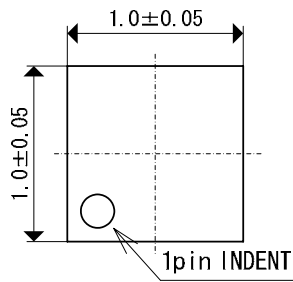

USPQ-4B04 Reference Pattern Layout (unit: mm)

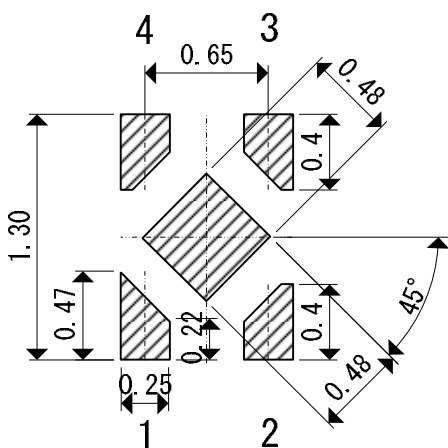

USPQ-4B04 Reference Metal Mask Design (unit: mm)

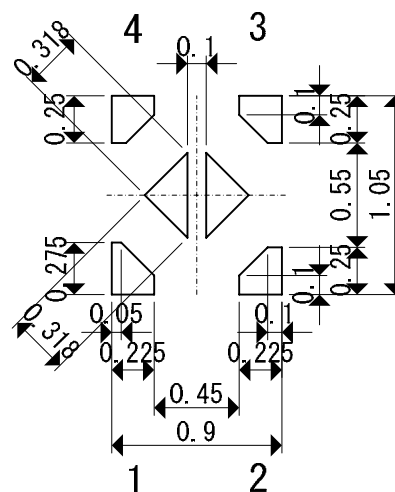

## PACKAGING INFORMATION (Continued)

USP-4 (unit: mm)

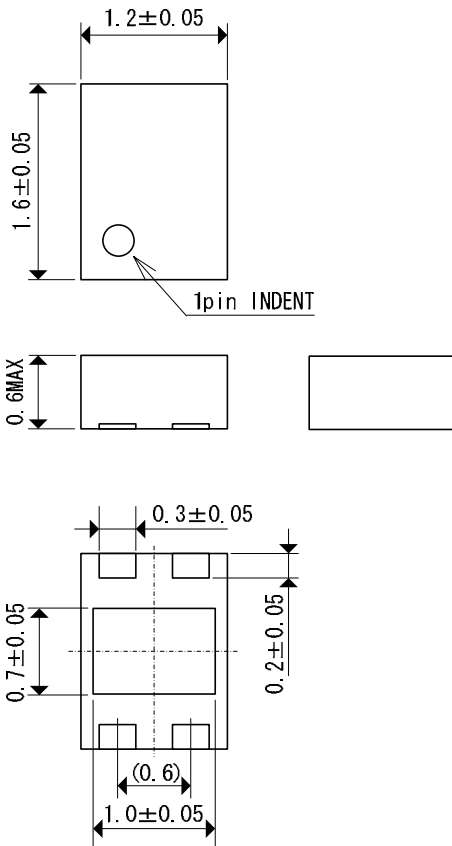

USP-4 Reference Pattern Layout (unit: mm)

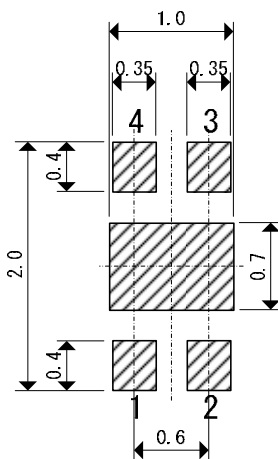

USP-4 Reference Metal Mask Design (unit: mm)

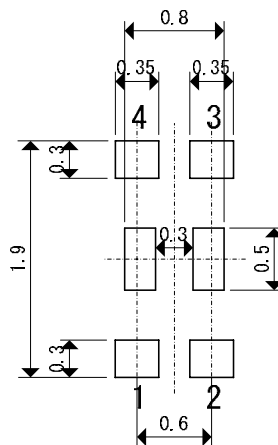



## PACKAGING INFORMATION (Continued)

SSOT-24 (unit: mm)

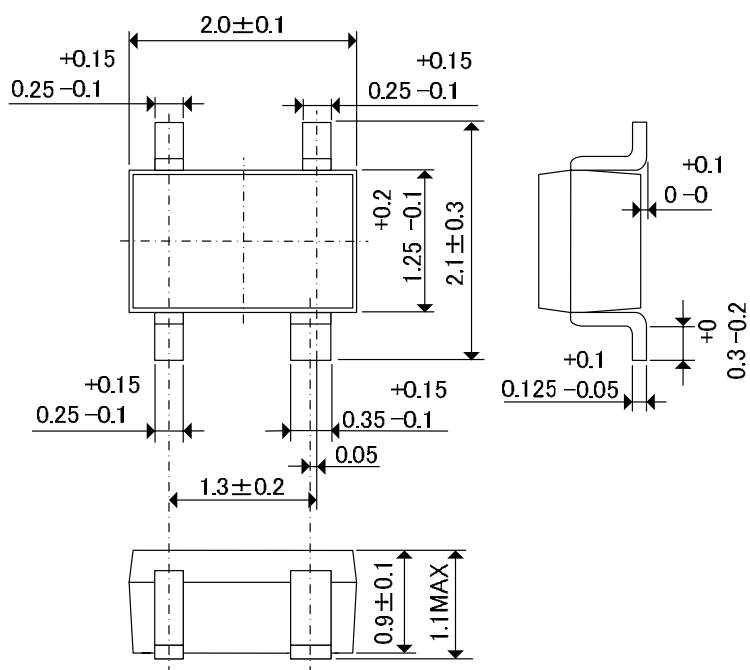

SOT-25 (unit: mm)

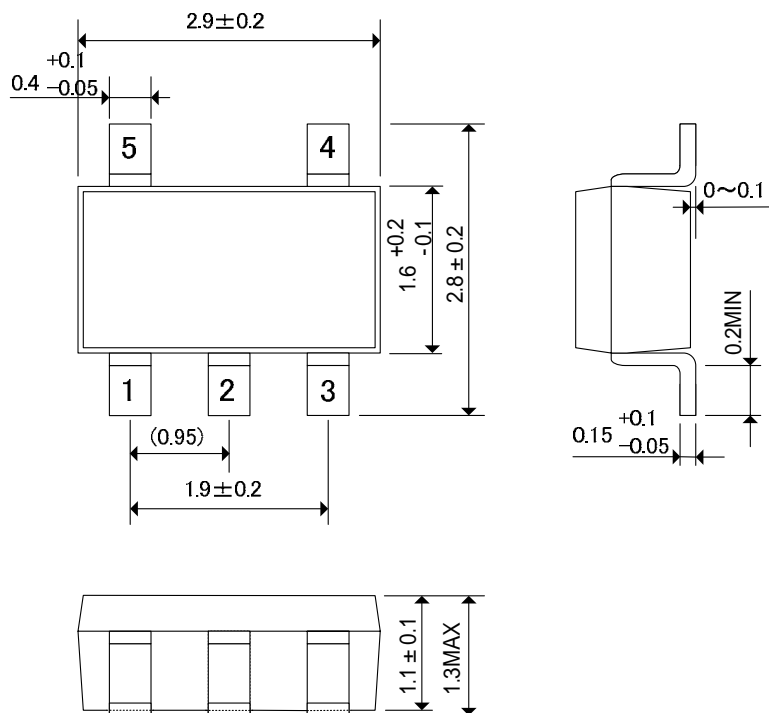

## USPQ-4B04 Power Dissipation

Power dissipation data for the USPQ-4B04 is shown in this page.  
 The value of power dissipation varies with the mount board conditions.  
 Please use this data as the reference data taken in the following condition.

### 1. Measurement Condition

- Condition : Mount on a board
- Ambient : Natural convection
- Soldering : Lead (Pb) free
- Board Dimensions : 40 x 40 mm (1600mm<sup>2</sup>)
- Board Structure : 4 Copper Layers
  - Each layer is connected to the package heat-sink and terminal pin No.1.
  - Each layer has approximately 800mm<sup>2</sup> copper area.
- Material : Glass Epoxy (FR-4)
- Thickness : 1.6 mm
- Through-hole : 4 x 0.8 Diameter

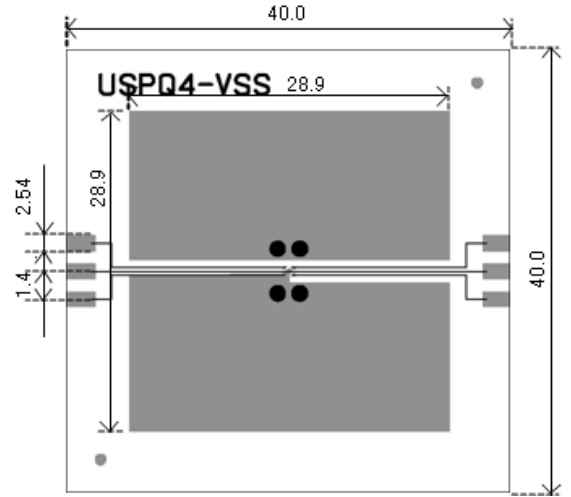

Evaluation Board (Unit: mm)

### 2. Power Dissipation vs. Ambient Temperature

Board Mount (T<sub>j</sub> max = 125 °C)

| Ambient Temperature ( °C ) | Power Dissipation Pd (mW) | Thermal Resistance ( °C /W) |
|----------------------------|---------------------------|-----------------------------|
| 25                         | 550                       | 181.82                      |
| 85                         | 220                       |                             |

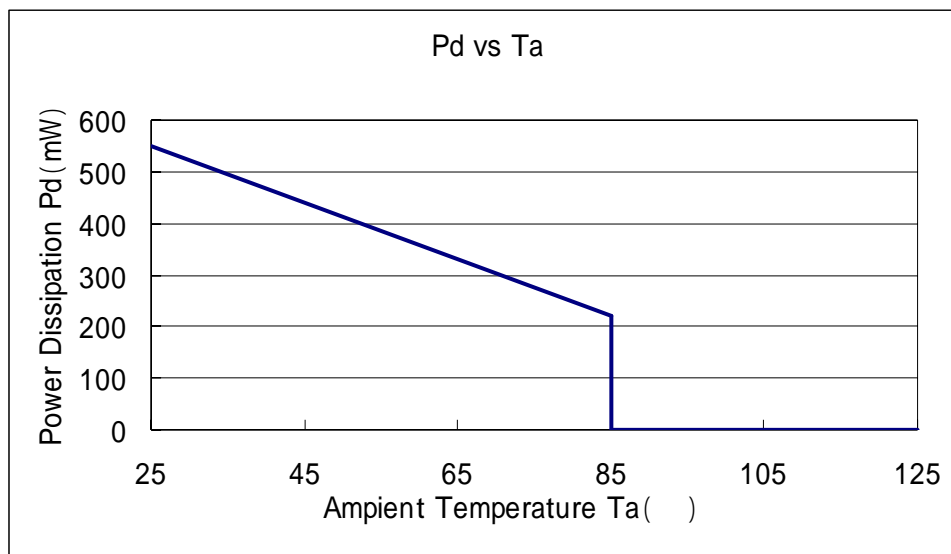

**USP-4 Power Dissipation**

Power dissipation data for the USP-4 is shown in this page.

The value of power dissipation varies with the mount board conditions.

Please use this data as the reference data taken in the following condition.

**1. Measurement Condition**

- Condition: Mount on a board
- Ambient: Natural convection
- Soldering: Lead (Pb) free
- Board: Dimensions 40 x 40 mm (1600mm<sup>2</sup> in one side)  
Copper (Cu) traces occupy 50% of the board area  
In top and back faces  
Package heat-sink is tied to the copper traces
- Material: Glass Epoxy (FR-4)
- Thickness: 1.6 mm
- Through-hole: 4 x 0.8 Diameter

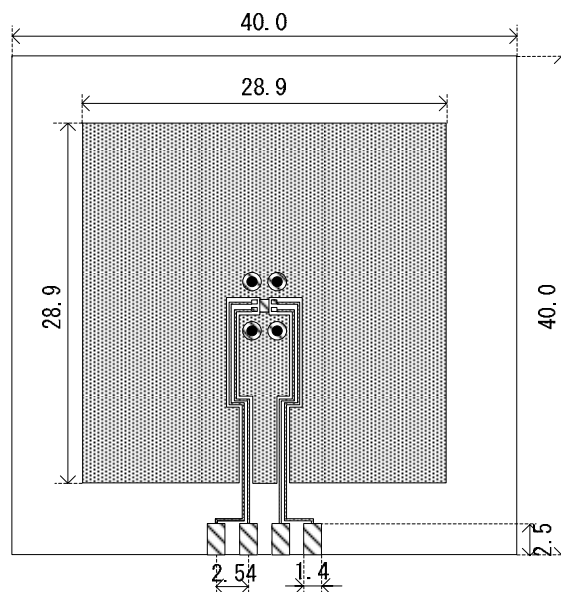

Evaluation Board (Unit: mm)

**2. Power Dissipation vs. Ambient Temperature**

Board Mount (T<sub>jmax</sub>=125 °C)

| Ambient Temperature ( °C ) | Power Dissipation Pd (mW) | Thermal Resistance ( °C/W) |
|----------------------------|---------------------------|----------------------------|
| 25                         | 1000                      | 100.00                     |
| 85                         | 400                       |                            |

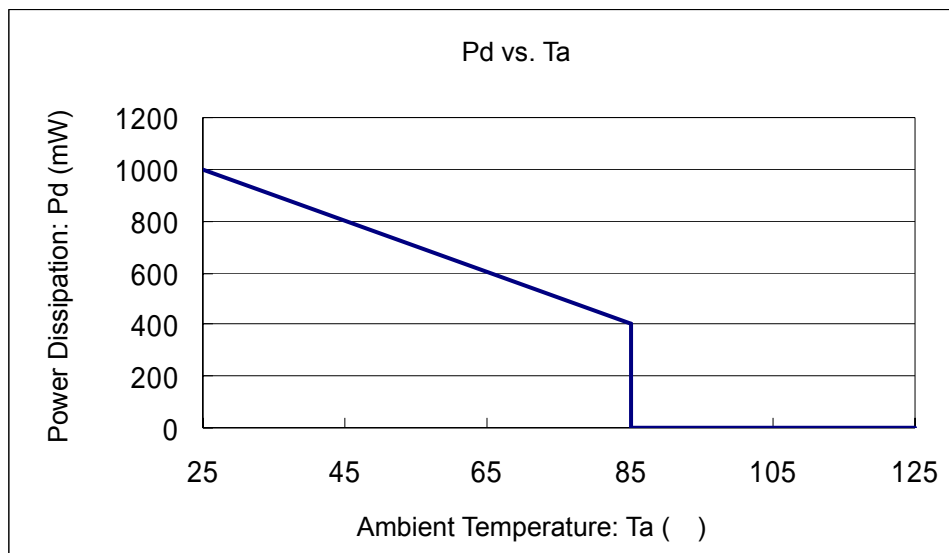

## SSOT-24 Power Dissipation

Power dissipation data for the SSOT-24 is shown in this page.

The value of power dissipation varies with the mount board conditions.

Please use this data as the reference data taken in the following condition.

### 1. Measurement Condition

- Condition: Mount on a board
- Ambient: Natural convection
- Soldering: Lead (Pb) free
- Board: Dimensions 40 x 40mm (1600mm<sup>2</sup> in one side)  
Copper (Cu) traces occupy 50% of the board area  
In top and back faces  
Package heat-sink is tied to the copper traces
- Material: Glass Epoxy (FR-4)
- Thickness: 1.6mm
- Through-hole: 4 x 0.8 Diameter

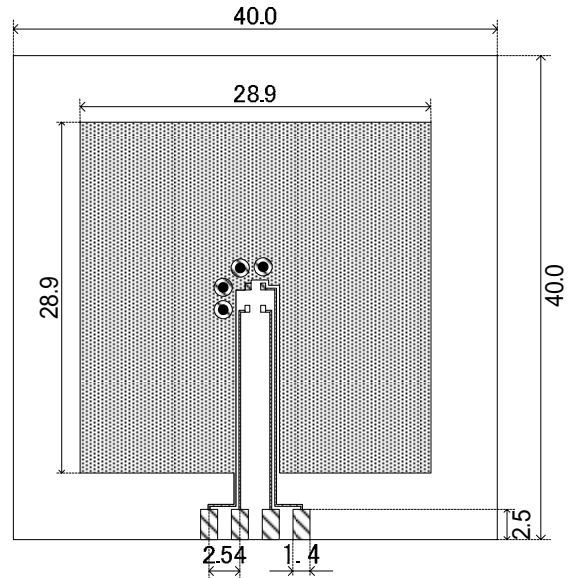

Evaluation Board (Unit: mm)

### 2. Power Dissipation vs. Ambient Temperature

Board Mount (T<sub>jmax</sub>=125 °C)

| Ambient Temperature ( °C ) | Power Dissipation Pd (mW) | Thermal Resistance ( °C/W ) |
|----------------------------|---------------------------|-----------------------------|
| 25                         | 500                       | 200.00                      |
| 85                         | 200                       |                             |

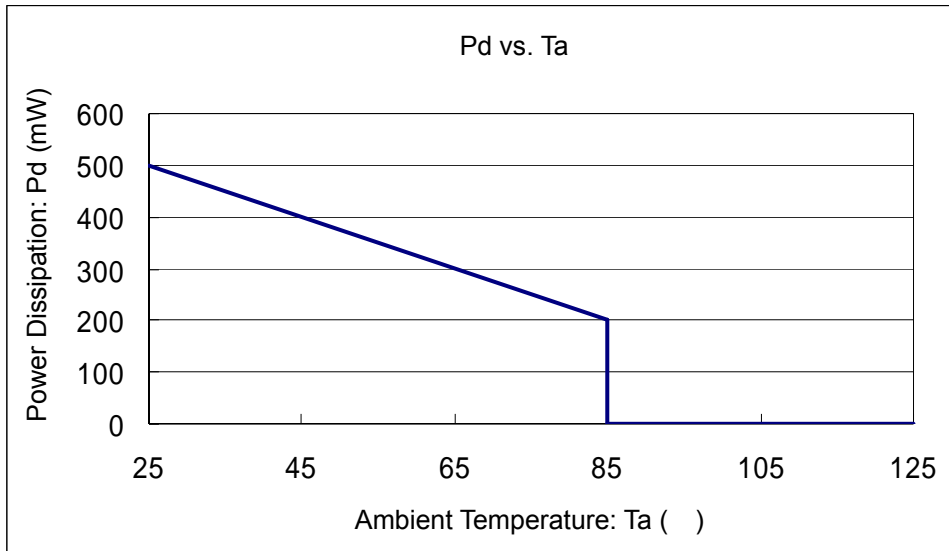

**SOT-25 Power Dissipation**

Power dissipation data for the SOT-25 is shown in this page.

The value of power dissipation varies with the mount board conditions.

Please use this data as the reference data taken in the following condition.

**1. Measurement Condition**

- Condition: Mount on a board
- Ambient: Natural convection
- Soldering: Lead (Pb) free
- Board: Dimensions 40 × 40mm (1600mm<sup>2</sup> in one side)  
Copper (Cu) traces occupy 50% of the board area  
In top and back faces  
Package heat-sink is tied to the copper traces  
(Board of SOT-26 is used)
- Material: Glass Epoxy (FR-4)
- Thickness: 1.6mm
- Through-hole: 4 × 0.8 Diameter

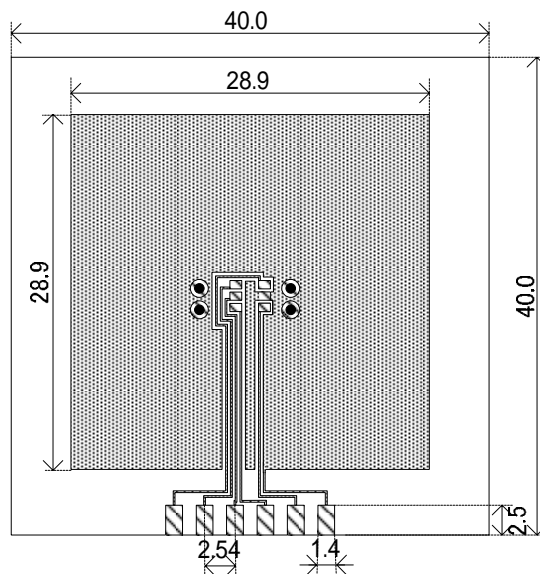

Evaluation Board (Unit: mm)

**2. Power Dissipation vs. Ambient Temperature**

Board Mount (Tjmax=125 )

| Ambient Temperature ( ) | Power Dissipation Pd (mW) | Thermal Resistance ( /W) |
|-------------------------|---------------------------|--------------------------|
| 25                      | 600                       | 166.67                   |
| 85                      | 240                       |                          |

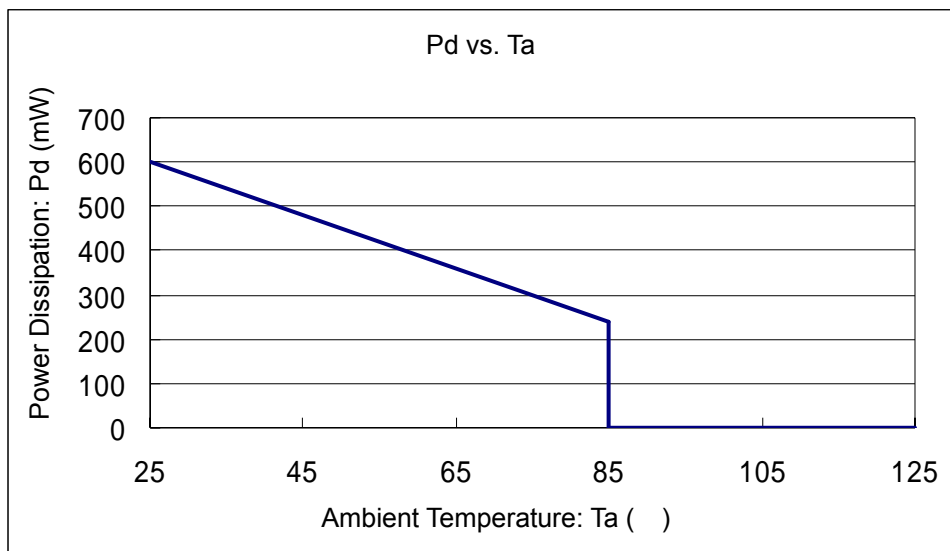

## MARKING RULE

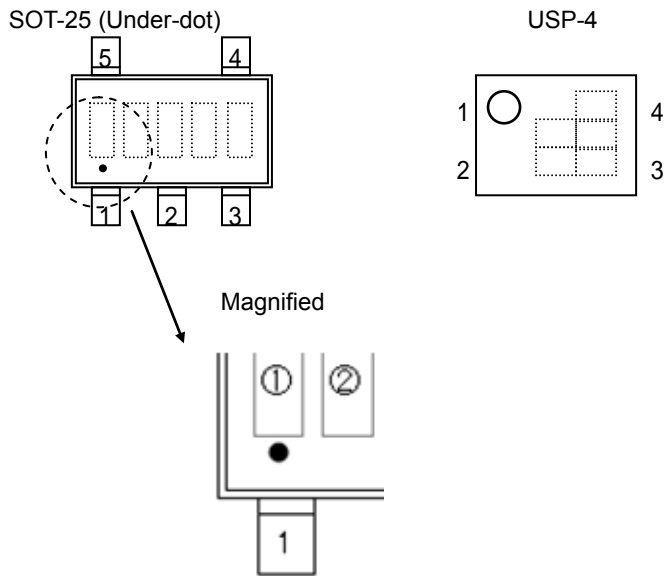

\* SOT-25 with the under-dot marking is used.

represents products series

| MARK | PRODUCT SERIES |
|------|----------------|
| 1    | XC6233*****-G  |

represents type of regulator

| MARK                              |                                    | PRODUCT SERIES |
|-----------------------------------|------------------------------------|----------------|
| OUTPUT VOLTAGE<br>0.1V Increments | OUTPUT VOLTAGE<br>0.05V Increments |                |
| K                                 | M                                  | XC6233H*****-G |

represents output voltage

| MARK | OUTPUT VOLTAGE (V) |      | MARK | OUTPUT VOLTAGE (V) |      |
|------|--------------------|------|------|--------------------|------|
| 0    | 1.2                | 1.25 | F    | 2.7                | 2.75 |
| 1    | 1.3                | 1.35 | H    | 2.8                | 2.85 |
| 2    | 1.4                | 1.45 | K    | 2.9                | 2.95 |
| 3    | 1.5                | 1.55 | L    | 3.0                | 3.05 |
| 4    | 1.6                | 1.65 | M    | 3.1                | 3.15 |
| 5    | 1.7                | 1.75 | N    | 3.2                | 3.25 |
| 6    | 1.8                | 1.85 | P    | 3.3                | 3.35 |
| 7    | 1.9                | 1.95 | R    | 3.4                | 3.45 |
| 8    | 2.0                | 2.05 | S    | 3.5                | 3.55 |
| 9    | 2.1                | 2.15 | T    | 3.6                | -    |
| A    | 2.2                | 2.25 | U    | -                  | -    |
| B    | 2.3                | 2.35 | V    | -                  | -    |
| C    | 2.4                | 2.45 | X    | -                  | -    |
| D    | 2.5                | 2.55 | Y    | -                  | -    |
| E    | 2.6                | 2.65 | Z    | -                  | -    |

, represents production lot number

01 ~ 09, 0A ~ 0Z, 11 ~ 9Z, A1 ~ A9, AA ~ AZ, B1 ~ ZZ in order.

(G, I, J, O, Q, W excluded)

\*No character inversion used.

## MARKING RULE (Continued)

SSOT-24 (With the orientation bar at the top)

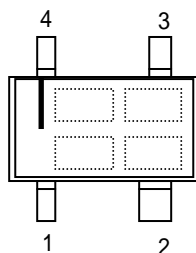

USPQ-4B04

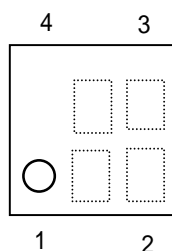

(XC6233\*\*\*\*\*-G with the orientation bar at the top is used.)

represents products series, type of regulator and output voltage

| MARK | OUTPUT VOLTAGE (V) | CURRENT LIMITER | CE PULL-DOWN RESISTOR | C <sub>L</sub> AUTO DISCHARGE | INRUSH CURRENT PREVENTION | PRODUCT SERIES                  |
|------|--------------------|-----------------|-----------------------|-------------------------------|---------------------------|---------------------------------|
| A    | 1.2 ~ 2.0          | Yes             | Yes                   | Yes                           | Yes                       | XC6233H121**-G ~ XC6233H201**-G |
| B    | 2.1 ~ 2.9          | Yes             | Yes                   | Yes                           | Yes                       | XC6233H211**-G ~ XC6233H291**-G |
| C    | 3.0 ~ 3.6          | Yes             | Yes                   | Yes                           | Yes                       | XC6233H301**-G ~ XC6233H361**-G |
| D    | 1.25 ~ 2.05        | Yes             | Yes                   | Yes                           | Yes                       | XC6233H12B**-G ~ XC6233H20B**-G |
| E    | 2.15 ~ 2.95        | Yes             | Yes                   | Yes                           | Yes                       | XC6233H21B**-G ~ XC6233H29B**-G |
| F    | 3.05 ~ 3.55        | Yes             | Yes                   | Yes                           | Yes                       | XC6233H30B**-G ~ XC6233H35B**-G |

represents output voltage

| MARK | OUTPUT VOLTAGE (V) |     |     |      |      |      |
|------|--------------------|-----|-----|------|------|------|
| 1    | 1.2                | 2.1 | 3.0 | 1.25 | 2.15 | 3.05 |
| 2    | 1.3                | 2.2 | 3.1 | 1.35 | 2.25 | 3.15 |
| 3    | 1.4                | 2.3 | 3.2 | 1.45 | 2.35 | 3.25 |
| 4    | 1.5                | 2.4 | 3.3 | 1.55 | 2.45 | 3.35 |
| 5    | 1.6                | 2.5 | 3.4 | 1.65 | 2.55 | 3.45 |
| 6    | 1.7                | 2.6 | 3.5 | 1.75 | 2.65 | 3.55 |
| 7    | 1.8                | 2.7 | 3.6 | 1.85 | 2.75 |      |
| 8    | 1.9                | 2.8 |     | 1.95 | 2.85 |      |
| 9    | 2.0                | 2.9 |     | 2.05 | 2.95 |      |

, represents production lot number

01 ~ 09, 0A ~ 0Z, 11 ~ 9Z, A1 ~ A9, AA ~ AZ, B1 ~ ZZ in order.

(G, I, J, O, Q, W excluded)

\*No character inversion used.

1. The products and product specifications contained herein are subject to change without notice to improve performance characteristics. Consult us, or our representatives before use, to confirm that the information in this datasheet is up to date.
2. We assume no responsibility for any infringement of patents, patent rights, or other rights arising from the use of any information and circuitry in this datasheet.
3. Please ensure suitable shipping controls (including fail-safe designs and aging protection) are in force for equipment employing products listed in this datasheet.
4. The products in this datasheet are not developed, designed, or approved for use with such equipment whose failure or malfunction can be reasonably expected to directly endanger the life of, or cause significant injury to, the user.  
(e.g. Atomic energy; aerospace; transport; combustion and associated safety equipment thereof.)
5. Please use the products listed in this datasheet within the specified ranges.  
Should you wish to use the products under conditions exceeding the specifications, please consult us or our representatives.
6. We assume no responsibility for damage or loss due to abnormal use.
7. All rights reserved. No part of this datasheet may be copied or reproduced without the prior permission of TOREX SEMICONDUCTOR LTD.

**TOREX SEMICONDUCTOR LTD.**