

SMBJ-Q Series

Surface Mount — 600W



 **AUTOMOTIVE GRADE** **HF** **RoHS**



Description

The SMBJ-Q series is designed specifically to protect sensitive electronic equipment from voltage transients induced by lightning and other transient voltage events. For surface mounted applications in order to optimize board space.

Additional Information



Maximum Ratings and Characteristics ($T_A=25^{\circ}\text{C}$)

Rating	Symbol	Value
Peak pulse power dissipation at 10/1000 μs waveform(Note1, Note2, Fig.1)	P_{PPM}	600W
Peak pulse current of at 10/1000 μs waveform (Note 1, Fig.3)	I_{PPM}	See Table(A)
Steady state power dissipation at $T_A=50^{\circ}\text{C}$ (Fig.5)	$P_{M(AV)}$	5.0W
Maximum Instantaneous Forward Voltage at 50A for Unidirectional Only	V_F	3.5V/5.0V
Peak forward surge current, 8.3ms single half sine-wave superimposed on rated load, (JEDEC Method) (Note3, Fig.6)	I_{FSM}	60A
Operating junction and Storage Temperature Ranges	T_J, T_{STG}	-55°C to $+150^{\circ}\text{C}$
Typical thermal resistance junction to lead	$R_{\theta JL}$	20°C/W
Typical thermal resistance junction to ambient	$R_{\theta JA}$	100°C/W

Notes:

1. Non-repetitive current pulse, per Fig.3 and derating above $T_A=25^{\circ}\text{C}$ per Fig.2.
2. Each terminal is surface Mounted on the 5.0mm \times 5.0mm(0.03mm thick) copper pads.
3. 8.3ms single half sine-wave or equivalent square wave, duty cycle=4 pulses per minutes maximum.
4. $V_F<3.5\text{V}$ for single die parts and $V_F<5.0\text{V}$ for stacked-die parts.

Features

- Halogen free and RoHS compliant
- Low profile package
- Built-in strain relief design
- Low inductance
- Excellent clamping capability
- 600W peak pulse power capability at 10/1000 μs waveform, repetition rate (duty cycle): 0.01%
- Fast response time
- Typical I_r less than 1 μA above 10V devices
- Peak 260 $^{\circ}\text{C}$ high temperature Reflow Soldering withstanding
- Meet MSL level1, per J-STD-020
- IEC-61000-4-2 ESD 30kV(Air), 30kV (Contact)
- Unit Weight: 0.10g
- AEC-Q101 Qualified

Functional Diagram

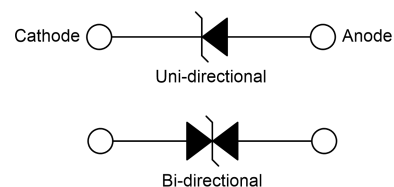

SMBJ-Q Series

Surface Mount — 600W

Electrical Characteristics (T_A=25°C)

Part Number		Type	Device Marking Code		Reverse Stand-Off Voltage	Breakdown Voltage @I _T		Test Current	Maximum Clamping Voltage @I _{PP}	Peak Pulse Current	Reverse Leakage @V _R
Uni.	Bi.		Uni.	Bi.	V _R (V)	V _{B Min.} (V)	V _{B Max.} (V)	I _T (mA)	V _C (V)	I _{PP} (A)	I _R (μA)
SMBJ5.0A	SMBJ5.0CA	Q	KE	AE	5.0	6.40	7.00	10	9.2	65.3	800
SMBJ6.0A	SMBJ6.0CA	Q	KG	AG	6.0	6.67	7.37	10	10.3	58.3	800
SMBJ6.5A	SMBJ6.5CA	Q	KK	AK	6.5	7.22	7.98	10	11.2	53.6	500
SMBJ7.0A	SMBJ7.0CA	Q	KM	AM	7.0	7.78	8.60	10	12.0	50.0	200
SMBJ7.5A	SMBJ7.5CA	Q	KP	AP	7.5	8.33	9.21	1	12.9	46.6	100
SMBJ8.0A	SMBJ8.0CA	Q	KR	AR	8.0	8.89	9.83	1	13.6	44.2	50
SMBJ8.5A	SMBJ8.5CA	Q	KT	AT	8.5	9.44	10.40	1	14.4	41.7	20
SMBJ9.0A	SMBJ9.0CA	Q	KV	AV	9.0	10.00	11.10	1	15.4	39.0	10
SMBJ10A	SMBJ10CA	Q	KX	AX	10.0	11.10	12.30	1	17.0	35.3	5
SMBJ11A	SMBJ11CA	Q	KZ	AZ	11.0	12.20	13.50	1	18.2	33.0	1
SMBJ12A	SMBJ12CA	Q	LE	BE	12.0	13.30	14.70	1	19.9	30.2	1
SMBJ13A	SMBJ13CA	Q	LG	BG	13.0	14.40	15.90	1	21.5	28.0	1
SMBJ14A	SMBJ14CA	Q	LK	BK	14.0	15.60	17.20	1	23.2	25.9	1
SMBJ15A	SMBJ15CA	Q	LM	BM	15.0	16.70	18.50	1	24.4	24.6	1
SMBJ16A	SMBJ16CA	Q	LP	BP	16.0	17.80	19.70	1	26.0	23.1	1
SMBJ17A	SMBJ17CA	Q	LR	BR	17.0	18.90	20.90	1	27.6	21.8	1
SMBJ18A	SMBJ18CA	Q	LT	BT	18.0	20.00	22.10	1	29.2	20.6	1
SMBJ20A	SMBJ20CA	Q	LV	BV	20.0	22.20	24.50	1	32.4	18.6	1
SMBJ22A	SMBJ22CA	Q	LX	BX	22.0	24.40	26.90	1	35.5	16.9	1
SMBJ24A	SMBJ24CA	Q	LZ	BZ	24.0	26.70	29.50	1	38.9	15.5	1
SMBJ26A	SMBJ26CA	Q	ME	CE	26.0	28.90	31.90	1	42.1	14.3	1
SMBJ28A	SMBJ28CA	Q	MG	CG	28.0	31.10	34.40	1	45.4	13.3	1
SMBJ30A	SMBJ30CA	Q	MK	CK	30.0	33.30	36.80	1	48.4	12.4	1
SMBJ33A	SMBJ33CA	Q	MM	CM	33.0	36.70	40.60	1	53.3	11.3	1
SMBJ36A	SMBJ36CA	Q	MP	CP	36.0	40.00	44.20	1	58.1	10.4	1
SMBJ40A	SMBJ40CA	Q	MR	CR	40.0	44.40	49.10	1	64.5	9.3	1
SMBJ43A	SMBJ43CA	Q	MT	CT	43.0	47.80	52.80	1	69.4	8.7	1
SMBJ45A	SMBJ45CA	Q	MV	CV	45.0	50.00	55.30	1	72.7	8.3	1
SMBJ48A	SMBJ48CA	Q	MX	CX	48.0	53.30	58.90	1	77.4	7.8	1
SMBJ51A	SMBJ51CA	Q	MZ	CZ	51.0	56.70	62.70	1	82.4	7.3	1
SMBJ54A	SMBJ54CA	Q	NE	DE	54.0	60.00	66.30	1	87.1	6.9	1

SMBJ-Q Series

Surface Mount — 600W

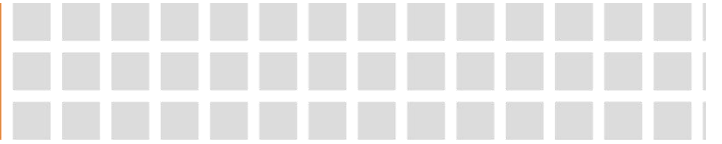

Part Number		Type	Device Marking Code		Reverse Stand-Off Voltage	Breakdown Voltage @ I_T		Test Current	Maximum Clamping Voltage @ I_{PP}	Peak Pulse Current	Reverse Leakage @ V_R
Uni.	Bi.		Uni.	Bi.	V_R (V)	$V_{B Min.}$ (V)	$V_{B Max.}$ (V)	I_T (mA)	V_C (V)	I_{PP} (A)	I_R (μ A)
SMBJ58A	SMBJ58CA	Q	NG	DG	58.0	64.40	71.20	1	93.6	6.5	1
SMBJ60A	SMBJ60CA	Q	NK	DK	60.0	66.70	73.70	1	96.8	6.2	1
SMBJ64A	SMBJ64CA	Q	NM	DM	64.0	71.10	78.60	1	103.0	5.9	1
SMBJ70A	SMBJ70CA	Q	NP	DP	70.0	77.80	86.00	1	113.0	5.3	1
SMBJ75A	SMBJ75CA	Q	NR	DR	75.0	83.30	92.10	1	121.0	5.0	1
SMBJ78A	SMBJ78CA	Q	NT	DT	78.0	86.70	95.80	1	126.0	4.8	1
SMBJ85A	SMBJ85CA	Q	NV	DV	85.0	94.40	104.00	1	137.0	4.4	1
SMBJ90A	SMBJ90CA	Q	NX	DX	90.0	100.00	111.00	1	146.0	4.1	1
SMBJ100A	SMBJ100CA	Q	NZ	DZ	100.0	111.00	123.00	1	162.0	3.7	1
SMBJ110A	SMBJ110CA	Q	PE	EE	110.0	122.00	135.00	1	177.0	3.4	1
SMBJ120A	SMBJ120CA	Q	PG	EG	120.0	133.00	147.00	1	193.0	3.1	1
SMBJ130A	SMBJ130CA	Q	PK	EK	130.0	144.00	159.00	1	209.0	2.9	1
SMBJ150A	SMBJ150CA	Q	PM	EM	150.0	167.00	185.00	1	243.0	2.5	1
SMBJ160A	SMBJ160CA	Q	PP	EP	160.0	178.00	197.00	1	259.0	2.3	1
SMBJ170A	SMBJ170CA	Q	PR	ER	170.0	189.00	209.00	1	275.0	2.2	1
SMBJ180A	SMBJ180CA	Q	PT	ET	180.0	201.00	222.00	1	292.0	2.1	1
SMBJ190A	SMBJ190CA	Q	PA	EC	190.0	211.00	233.00	1	308.0	2.0	1
SMBJ200A	SMBJ200CA	Q	PV	EV	200.0	224.00	247.00	1	324.0	1.9	1
SMBJ210A	SMBJ210CA	Q	PB	ED	210.0	237.00	263.00	1	340.0	1.8	1
SMBJ220A	SMBJ220CA	Q	PX	EX	220.0	246.00	272.00	1	356.0	1.7	1
SMBJ250A	SMBJ250CA	Q	PZ	EZ	250.0	279.00	309.00	1	405.0	1.5	1

SMBJ-Q Series
Surface Mount — 600W

Ratings and Characteristic Curves ($T_A=25^\circ\text{C}$)

Figure 1. Peak Pulse Power Rating Curve

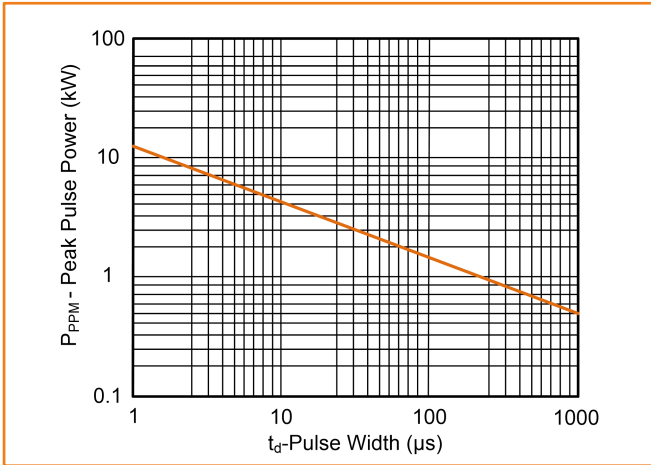

Figure 2. Pulse Derating Curve

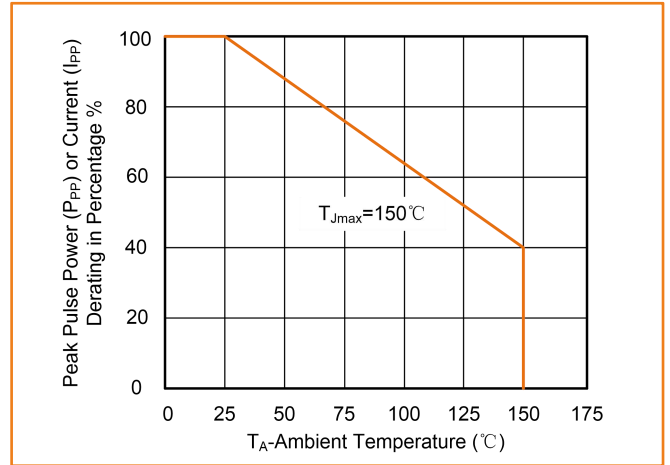

Figure 3. Pulse Waveform

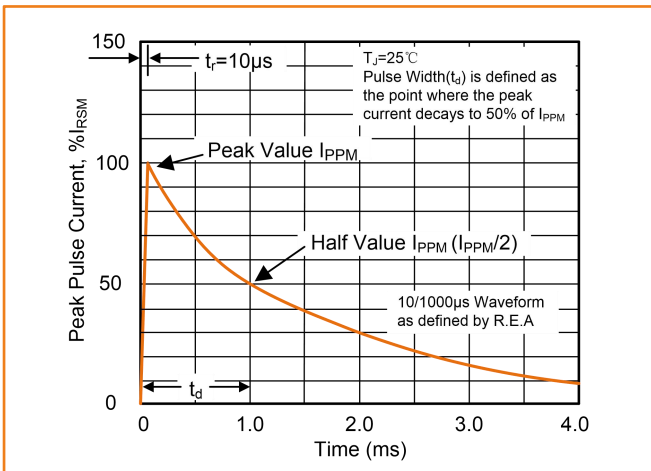

Figure 4. Typical Junction Capacitance

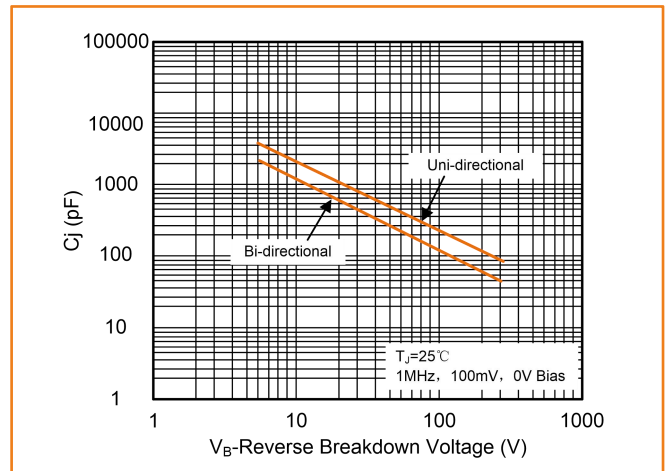

Figure 5. Steady State Power Dissipation Derating Curve

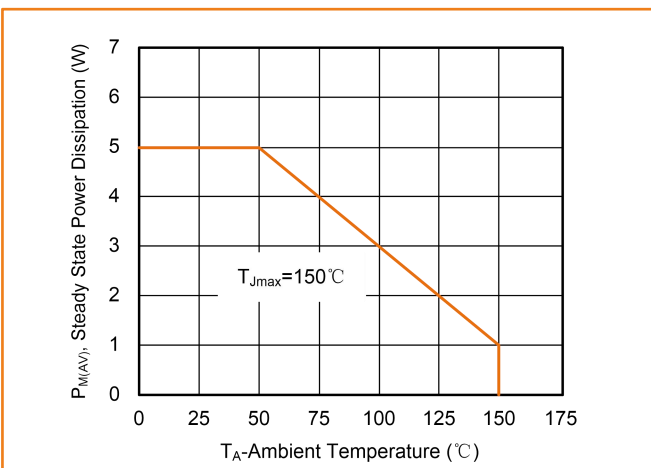
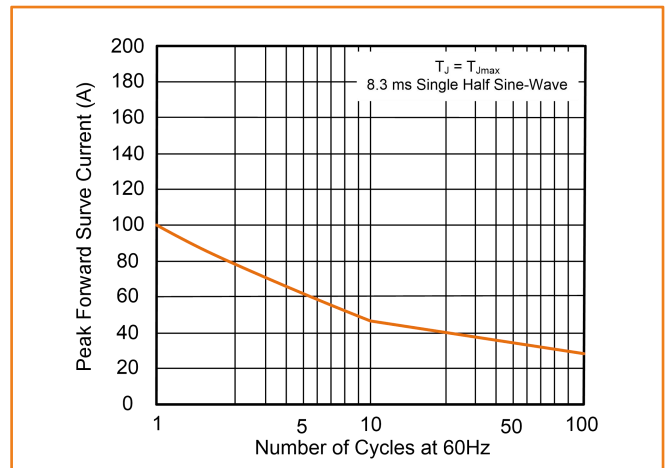

Figure 6. Maximum Non-Repetitive Forward Surge Current Uni-Directional



SMBJ-Q Series

Surface Mount — 600W

Soldering Parameters

Reflow Condition		Lead-free
Pre Heat	-Temperature Min ($T_{S\ min}$)	150°C
	-Temperature Max ($T_{S\ max}$)	200°C
	-Time (min to max) (t_s)	60 — 180 secs
Average ramp-up rate (T_L to T_P)		3°C/second max.
$T_{S\ max}$ to T_L -Ramp-up Rate		3°C/second max.
Time maintained above:	-Temperature (T_L)	217°C
	-Time (t_L)	60–150 seconds
Peak Temperature (T_P)		260°C
Time within 5°C of actual Peak Temperature (t_p)		20–40 seconds
Ramp-down Rate		6°C/second max.
Time 25°C to Peak Temperature		8 minutes max.

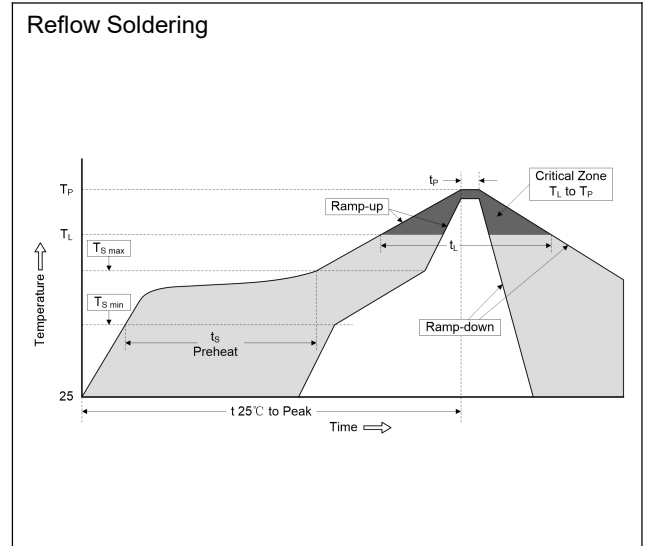

Dimensions (SMB/DO-214AA)

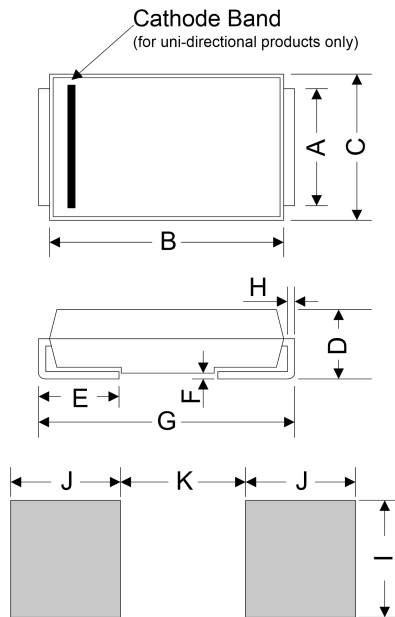

Symbol	Millimeters		Inches	
	Min.	Max.	Min.	Max.
A	1.930	2.200	0.076	0.086
B	4.060	4.750	0.160	0.187
C	3.300	3.940	0.130	0.155
D	2.160	2.650	0.085	0.104
E	0.760	1.520	0.030	0.060
F	-	0.203	-	0.008
G	5.210	5.590	0.205	0.220
H	0.152	0.305	0.006	0.012
I	2.260	-	0.089	-
J	2.160	-	0.085	-
K	-	2.740	-	0.107

SMBJ-Q Series
Surface Mount — 600W

Part Number Code and Marking Code

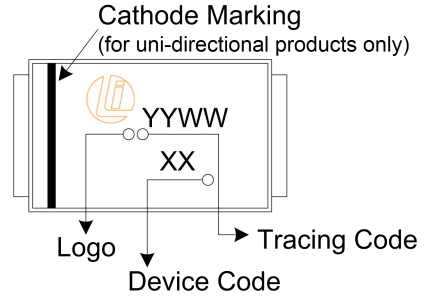
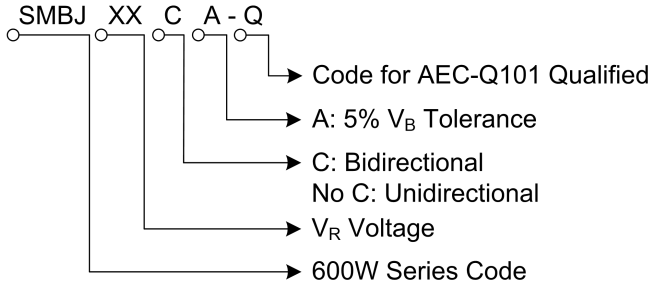

Packaging Specification

Tape

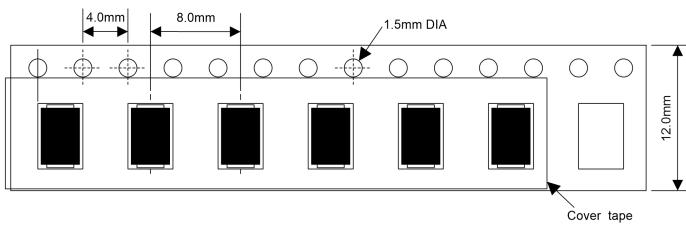

For Uni-Devices

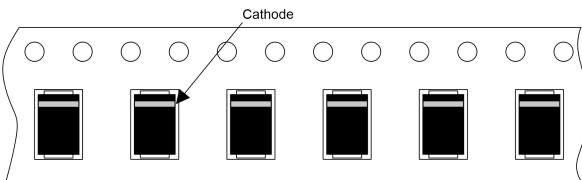

13 Inches Reel

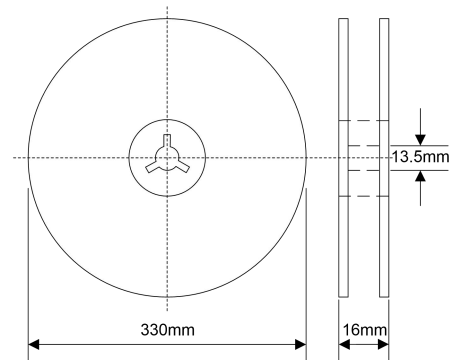

Quantity: 3000pcs/reel