

# SMAJ Series

Surface Mount — 400W

**HF** **RoHS**



SMA

## Additional Information



## Maximum Ratings and Characteristics ( $T_A=25^{\circ}\text{C}$ )

| Rating  | Symbol          | Value   |
|---|-----------------|---|
| Peak pulse power dissipation at 10/1000 $\mu\text{s}$ waveform(Note1, Note2, Fig.1)                               | $P_{PPM}$       | 400W  |
| Peak pulse current of at 10/1000 $\mu\text{s}$ waveform (Note 1, Fig.3)   | $I_{PPM}$       | See Table(A)                                    |
| Steady state power dissipation at $T_A=50^{\circ}\text{C}$ (Fig.5)  | $P_{M(AV)}$     | 3.3W  |
| Maximum Instantaneous Forward Voltage at 25A for Unidirectional Only  | $V_F$           | 3.5V/5.0V                                       |
| Peak forward surge current, 8.3ms single half sine-wave superimposed on rated load, (JEDEC Method) (Note3, Fig.6) | $I_{FSM}$       | 60A   |
| Operating junction and Storage Temperature Ranges   | $T_J, T_{STG}$  | $-55^{\circ}\text{C}$ to $+150^{\circ}\text{C}$ |
| Typical thermal resistance junction to lead   | $R_{\theta JL}$ | $30^{\circ}\text{C/W}$                          |
| Typical thermal resistance junction to ambient  | $R_{\theta JA}$ | $120^{\circ}\text{C/W}$                         |

Notes:

1. Non-repetitive current pulse, per Fig.3 and derating above  $T_A=25^{\circ}\text{C}$  per Fig.2.
2. Each terminal is surface Mounted on the 5.0mm $\times$ 5.0mm(0.03mm thick) copper pads.
3. 8.3ms single half sine-wave or equivalent square wave, duty cycle=4 pulses per minutes maximum.
4.  $V_F<3.5\text{V}$  for single die parts and  $V_F<5.0\text{V}$  for stacked-die parts.

## Description

The SMAJ series is designed specifically to protect sensitive electronic equipment from voltage transients induced by lightning and other transient voltage events. For surface mounted applications in order to optimize board space.

## Features

- Halogen free and RoHS compliant
- Low profile package
- Built-in strain relief design
- Low inductance
- Excellent clamping capability
- 400W peak pulse power capability at 10/1000 $\mu\text{s}$  waveform, repetition rate (duty cycle): 0.01%
- Fast response time
- Typical  $I_r$  less than 1 $\mu\text{A}$  above 10V devices
- Peak 260  $^{\circ}\text{C}$  high temperature Reflow Soldering withstanding
- Meet MSL level1, per J-STD-020
- IEC-61000-4-2 ESD 30kV(Air), 30kV (Contact)
- Unit Weight: 0.07g

## Applications

TVS components are ideal for the protection of I/O Interfaces, VCC bus and other vulnerable circuits used in telecom, computer, Industrial and consumer electronic applications.

## Functional Diagram

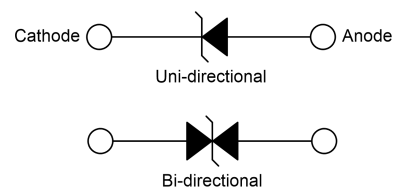

# SMAJ Series

Surface Mount — 400W

## Electrical Characteristics ( $T_A=25^\circ\text{C}$ )

| Part Number |           | Device Marking Code |     | Reverse Stand-Off Voltage | Breakdown Voltage @ $I_T$ |                   | Test Current | Maximum Clamping Voltage @ $I_{PP}$ | Peak Pulse Current | Reverse Leakage @ $V_R$ |
|-------------|-----------|---------------------|-----|---------------------------|---------------------------|-------------------|--------------|-------------------------------------|--------------------|-------------------------|
| Uni.        | Bi.       | Uni.                | Bi. | $V_R$ (V)                 | $V_{B\ Min.}$ (V)         | $V_{B\ Max.}$ (V) | $I_T$ (mA)   | $V_C$ (V)                           | $I_{PP}$ (A)       | $I_R$ ( $\mu\text{A}$ ) |
| SMAJ5.0A    | SMAJ5.0CA | AE                  | WE  | 5.0                       | 6.40                      | 7.00              | 10           | 9.2                                 | 43.5               | 800                     |
| SMAJ6.0A    | SMAJ6.0CA | AG                  | WG  | 6.0                       | 6.67                      | 7.37              | 10           | 10.3                                | 38.8               | 800                     |
| SMAJ6.5A    | SMAJ6.5CA | AK                  | WK  | 6.5                       | 7.22                      | 7.98              | 10           | 11.2                                | 35.7               | 500                     |
| SMAJ7.0A    | SMAJ7.0CA | AM                  | WM  | 7.0                       | 7.78                      | 8.60              | 10           | 12.0                                | 33.3               | 200                     |
| SMAJ7.5A    | SMAJ7.5CA | AP                  | WP  | 7.5                       | 8.33                      | 9.21              | 1            | 12.9                                | 31.0               | 100                     |
| SMAJ8.0A    | SMAJ8.0CA | AR                  | WR  | 8.0                       | 8.89                      | 9.83              | 1            | 13.6                                | 29.4               | 50                      |
| SMAJ8.5A    | SMAJ8.5CA | AT                  | WT  | 8.5                       | 9.44                      | 10.40             | 1            | 14.4                                | 27.8               | 20                      |
| SMAJ9.0A    | SMAJ9.0CA | AV                  | WV  | 9.0                       | 10.00                     | 11.10             | 1            | 15.4                                | 26.0               | 10                      |
| SMAJ10A     | SMAJ10CA  | AX                  | WX  | 10.0                      | 11.10                     | 12.30             | 1            | 17.0                                | 23.5               | 5                       |
| SMAJ11A     | SMAJ11CA  | AZ                  | WZ  | 11.0                      | 12.20                     | 13.50             | 1            | 18.2                                | 22.0               | 1                       |
| SMAJ12A     | SMAJ12CA  | BE                  | XE  | 12.0                      | 13.30                     | 14.70             | 1            | 19.9                                | 20.1               | 1                       |
| SMAJ13A     | SMAJ13CA  | BG                  | XG  | 13.0                      | 14.40                     | 15.90             | 1            | 21.5                                | 18.6               | 1                       |
| SMAJ14A     | SMAJ14CA  | BK                  | XK  | 14.0                      | 15.60                     | 17.20             | 1            | 23.2                                | 17.2               | 1                       |
| SMAJ15A     | SMAJ15CA  | BM                  | XM  | 15.0                      | 16.70                     | 18.50             | 1            | 24.4                                | 16.4               | 1                       |
| SMAJ16A     | SMAJ16CA  | BP                  | XP  | 16.0                      | 17.80                     | 19.70             | 1            | 26.0                                | 15.4               | 1                       |
| SMAJ17A     | SMAJ17CA  | BR                  | XR  | 17.0                      | 18.90                     | 20.90             | 1            | 27.6                                | 14.5               | 1                       |
| SMAJ18A     | SMAJ18CA  | BT                  | XT  | 18.0                      | 20.00                     | 22.10             | 1            | 29.2                                | 13.7               | 1                       |
| SMAJ20A     | SMAJ20CA  | BV                  | XV  | 20.0                      | 22.20                     | 24.50             | 1            | 32.4                                | 12.3               | 1                       |
| SMAJ22A     | SMAJ22CA  | BX                  | XX  | 22.0                      | 24.40                     | 26.90             | 1            | 35.5                                | 11.3               | 1                       |
| SMAJ24A     | SMAJ24CA  | BZ                  | XZ  | 24.0                      | 26.70                     | 29.50             | 1            | 38.9                                | 10.3               | 1                       |
| SMAJ26A     | SMAJ26CA  | CE                  | YE  | 26.0                      | 28.90                     | 31.90             | 1            | 42.1                                | 9.5                | 1                       |
| SMAJ28A     | SMAJ28CA  | CG                  | YG  | 28.0                      | 31.10                     | 34.40             | 1            | 45.4                                | 8.8                | 1                       |
| SMAJ30A     | SMAJ30CA  | CK                  | YK  | 30.0                      | 33.30                     | 36.80             | 1            | 48.4                                | 8.3                | 1                       |
| SMAJ33A     | SMAJ33CA  | CM                  | YM  | 33.0                      | 36.70                     | 40.60             | 1            | 53.3                                | 7.5                | 1                       |
| SMAJ36A     | SMAJ36CA  | CP                  | YP  | 36.0                      | 40.00                     | 44.20             | 1            | 58.1                                | 6.9                | 1                       |
| SMAJ40A     | SMAJ40CA  | CR                  | YR  | 40.0                      | 44.40                     | 49.10             | 1            | 64.5                                | 6.2                | 1                       |
| SMAJ43A     | SMAJ43CA  | CT                  | YT  | 43.0                      | 47.80                     | 52.80             | 1            | 69.4                                | 5.8                | 1                       |
| SMAJ45A     | SMAJ45CA  | CV                  | YV  | 45.0                      | 50.00                     | 55.30             | 1            | 72.7                                | 5.5                | 1                       |
| SMAJ48A     | SMAJ48CA  | CX                  | YX  | 48.0                      | 53.30                     | 58.90             | 1            | 77.4                                | 5.2                | 1                       |
| SMAJ51A     | SMAJ51CA  | CZ                  | YZ  | 51.0                      | 56.70                     | 62.70             | 1            | 82.4                                | 4.9                | 1                       |
| SMAJ54A     | SMAJ54CA  | RE                  | ZE  | 54.0                      | 60.00                     | 66.30             | 1            | 87.1                                | 4.6                | 1                       |

# SMAJ Series

Surface Mount — 400W

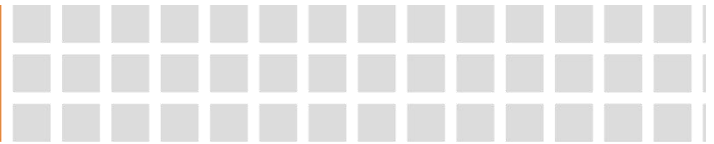

| Part Number |           | Device Marking Code |     | Reverse Stand-Off Voltage | Breakdown Voltage @ $I_T$ |                  | Test Current | Maximum Clamping Voltage @ $I_{PP}$ | Peak Pulse Current | Reverse Leakage @ $V_R$ |
|-------------|-----------|---------------------|-----|---------------------------|---------------------------|------------------|--------------|-------------------------------------|--------------------|-------------------------|
| Uni.        | Bi.       | Uni.                | Bi. | $V_R$ (V)                 | $V_{B Min.}$ (V)          | $V_{B Max.}$ (V) | $I_T$ (mA)   | $V_C$ (V)                           | $I_{PP}$ (A)       | $I_R$ ( $\mu$ A)        |
| SMAJ58A     | SMAJ58CA  | RG                  | ZG  | 58.0                      | 64.40                     | 71.20            | 1            | 93.6                                | 4.3                | 1                       |
| SMAJ60A     | SMAJ60CA  | RK                  | ZK  | 60.0                      | 66.70                     | 73.70            | 1            | 96.8                                | 4.1                | 1                       |
| SMAJ64A     | SMAJ64CA  | RM                  | ZM  | 64.0                      | 71.10                     | 78.60            | 1            | 103.0                               | 3.9                | 1                       |
| SMAJ70A     | SMAJ70CA  | RP                  | ZP  | 70.0                      | 77.80                     | 86.00            | 1            | 113.0                               | 3.5                | 1                       |
| SMAJ75A     | SMAJ75CA  | RR                  | ZR  | 75.0                      | 83.30                     | 92.10            | 1            | 121.0                               | 3.3                | 1                       |
| SMAJ78A     | SMAJ78CA  | RT                  | ZT  | 78.0                      | 86.70                     | 95.80            | 1            | 126.0                               | 3.2                | 1                       |
| SMAJ85A     | SMAJ85CA  | RV                  | ZV  | 85.0                      | 94.40                     | 104.00           | 1            | 137.0                               | 2.9                | 1                       |
| SMAJ90A     | SMAJ90CA  | RX                  | ZX  | 90.0                      | 100.00                    | 111.00           | 1            | 146.0                               | 2.7                | 1                       |
| SMAJ100A    | SMAJ100CA | RZ                  | ZZ  | 100.0                     | 111.00                    | 123.00           | 1            | 162.0                               | 2.5                | 1                       |
| SMAJ110A    | SMAJ110CA | SE                  | VE  | 110.0                     | 122.00                    | 135.00           | 1            | 177.0                               | 2.3                | 1                       |
| SMAJ120A    | SMAJ120CA | SG                  | VG  | 120.0                     | 133.00                    | 147.00           | 1            | 193.0                               | 2.1                | 1                       |
| SMAJ130A    | SMAJ130CA | SK                  | VK  | 130.0                     | 144.00                    | 159.00           | 1            | 209.0                               | 1.9                | 1                       |
| SMAJ150A    | SMAJ150CA | SM                  | VM  | 150.0                     | 167.00                    | 185.00           | 1            | 243.0                               | 1.6                | 1                       |
| SMAJ160A    | SMAJ160CA | SP                  | VP  | 160.0                     | 178.00                    | 197.00           | 1            | 259.0                               | 1.5                | 1                       |
| SMAJ170A    | SMAJ170CA | SR                  | VR  | 170.0                     | 189.00                    | 209.00           | 1            | 275.0                               | 1.5                | 1                       |
| SMAJ180A    | SMAJ180CA | ST                  | VT  | 180.0                     | 201.00                    | 222.00           | 1            | 292.0                               | 1.4                | 1                       |
| SMAJ190A    | SMAJ190CA | SU                  | YU  | 190.0                     | 211.00                    | 233.00           | 1            | 308.0                               | 1.3                | 1                       |
| SMAJ200A    | SMAJ200CA | SV                  | VV  | 200.0                     | 224.00                    | 247.00           | 1            | 324.0                               | 1.2                | 1                       |
| SMAJ210A    | SMAJ210CA | SW                  | YW  | 210.0                     | 237.00                    | 263.00           | 1            | 340.0                               | 1.2                | 1                       |
| SMAJ220A    | SMAJ220CA | GE                  | VX  | 220.0                     | 246.00                    | 272.00           | 1            | 356.0                               | 1.1                | 1                       |
| SMAJ250A    | SMAJ250CA | SZ                  | VZ  | 250.0                     | 279.00                    | 309.00           | 1            | 405.0                               | 1.0                | 1                       |
| SMAJ300A    | SMAJ300CA | TE                  | UE  | 300.0                     | 335.00                    | 371.00           | 1            | 486.0                               | 0.8                | 1                       |
| SMAJ350A    | SMAJ350CA | TG                  | UG  | 350.0                     | 391.00                    | 432.00           | 1            | 567.0                               | 0.7                | 1                       |
| SMAJ400A    | SMAJ400CA | TK                  | UK  | 400.0                     | 447.00                    | 494.00           | 1            | 648.0                               | 0.6                | 1                       |
| SMAJ440A    | SMAJ440CA | TM                  | UM  | 440.0                     | 492.00                    | 543.00           | 1            | 713.0                               | 0.6                | 1                       |

# SMAJ Series

Surface Mount — 400W

## Ratings and Characteristic Curves ( $T_A=25^\circ\text{C}$ )

Figure 1. Peak Pulse Power Rating Curve

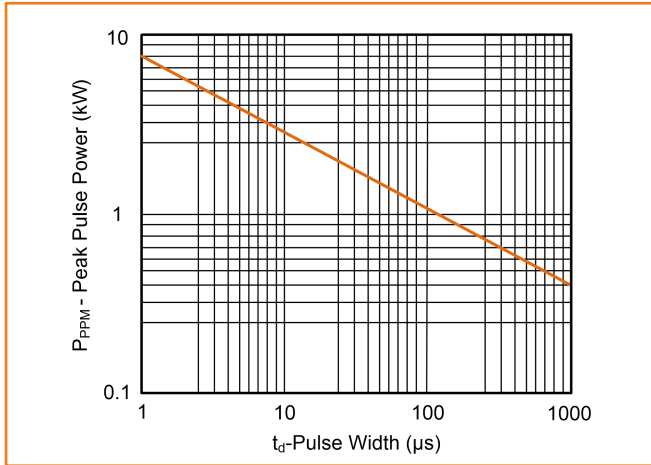

Figure 2. Pulse Derating Curve

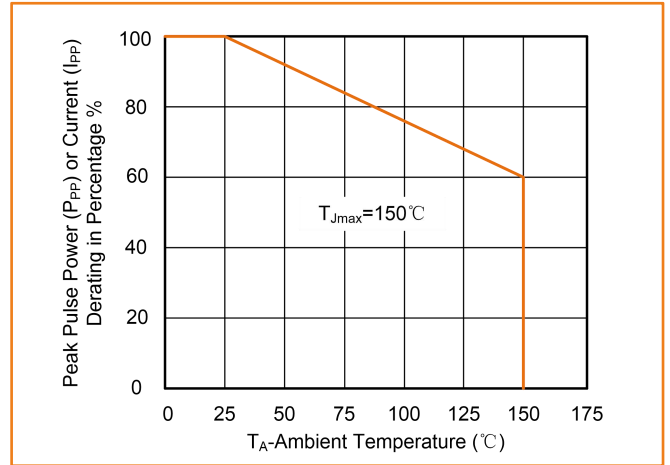

Figure 3. Pulse Waveform

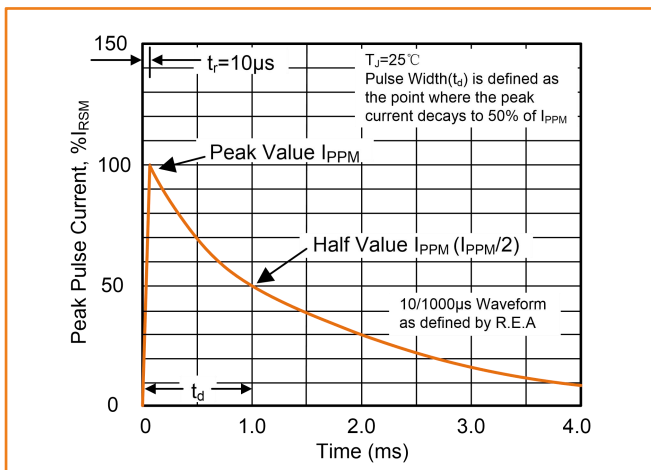

Figure 4. Typical Junction Capacitance

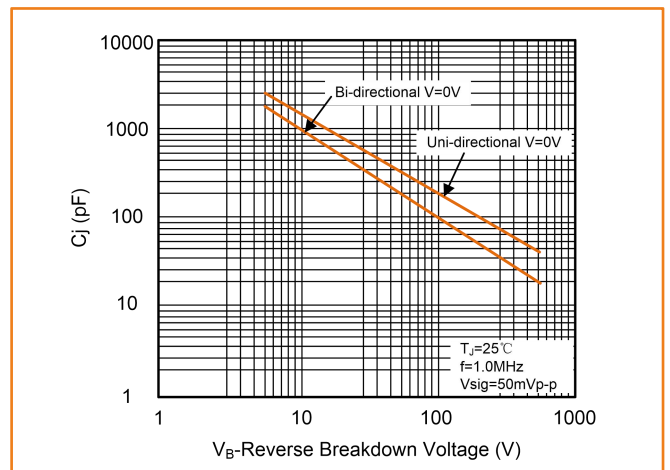

Figure 5. Steady State Power Dissipation Derating Curve

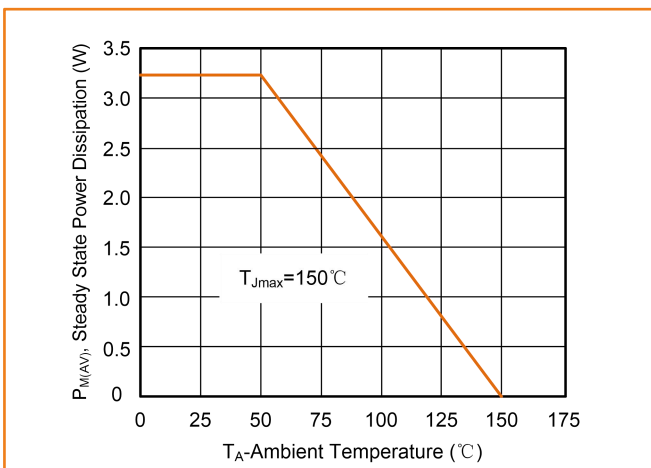
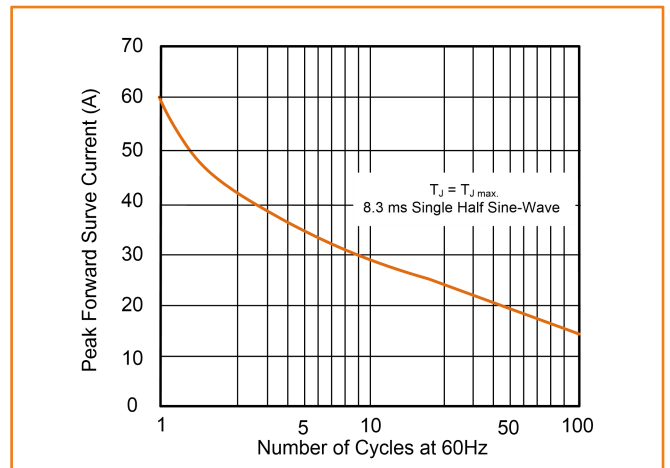

Figure 6. Maximum Non-Repetitive Forward Surge Current Uni-Directional



# SMAJ Series

Surface Mount — 400W

## Soldering Parameters

| Reflow Condition                                     |                                   | Lead-free       |
|--|-----------------------------------|-----------------|
| Pre Heat   | -Temperature Min ( $T_{S\ min}$ ) | 150°C           |
|  | -Temperature Max ( $T_{S\ max}$ ) | 200°C           |
|  | -Time (min to max) ( $t_s$ )      | 60 — 180 secs   |
| Average ramp-up rate ( $T_L$ to $T_P$ )              |                                   | 3°C/second max. |
| $T_{S\ max}$ to $T_L$ -Ramp-up Rate                  |                                   | 3°C/second max. |
| Time maintained above:                               | -Temperature ( $T_L$ )            | 217°C           |
|  | -Time ( $t_L$ )                   | 60–150 seconds  |
| Peak Temperature ( $T_P$ )                           |                                   | 260°C           |
| Time within 5°C of actual Peak Temperature ( $t_p$ ) |                                   | 20–40 seconds   |
| Ramp-down Rate                                       |                                   | 6°C/second max. |
| Time 25°C to Peak Temperature                        |                                   | 8 minutes max.  |

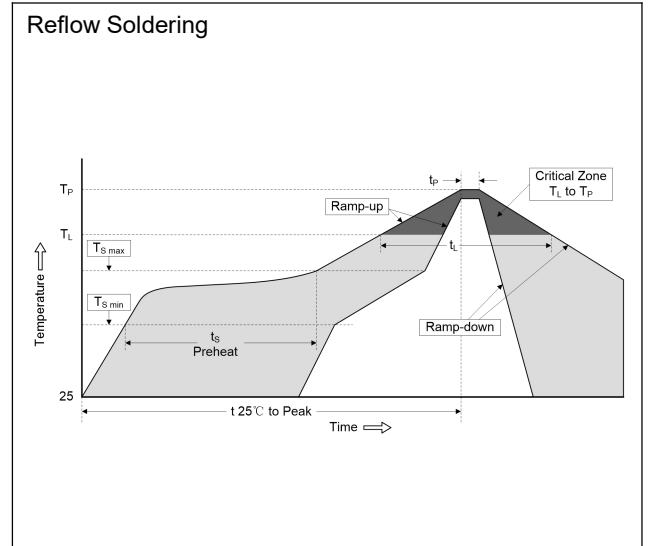

## Dimensions (SMA/DO-214AC)



| Symbol | Millimeters |       | Inches |       |
|--------|-------------|-------|--------|-------|
|        | Min.        | Max.  | Min.   | Max.  |
| A      | 1.250       | 1.650 | 0.049  | 0.065 |
| B      | 3.990       | 4.600 | 0.157  | 0.181 |
| C      | 2.400       | 2.790 | 0.095  | 0.110 |
| D      | 1.900       | 2.290 | 0.075  | 0.090 |
| E      | 0.780       | 1.520 | 0.030  | 0.060 |
| F      | —           | 0.203 | —      | 0.008 |
| G      | 4.800       | 5.280 | 0.189  | 0.208 |
| H      | 0.152       | 0.305 | 0.006  | 0.012 |
| I      | 1.800       | —     | 0.070  | —     |
| J      | 2.100       | —     | 0.082  | —     |
| K      | —           | 2.300 | —      | 0.090 |

# SMAJ Series

Surface Mount — 400W

## Part Number Code and Marking Code

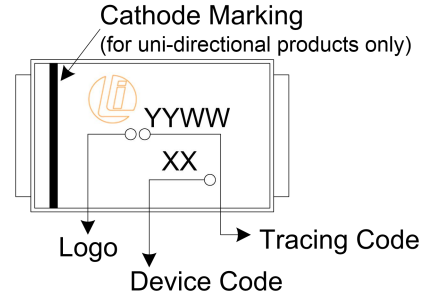
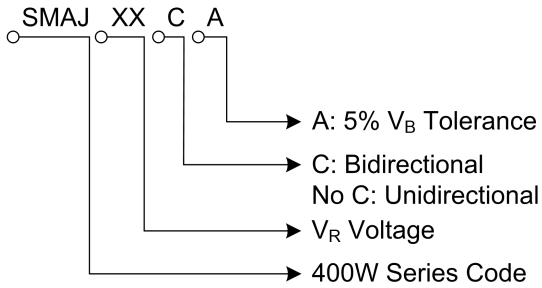

## Packaging Specification

### Tape

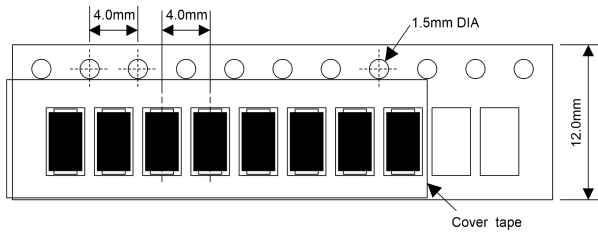

### For Uni-Devices

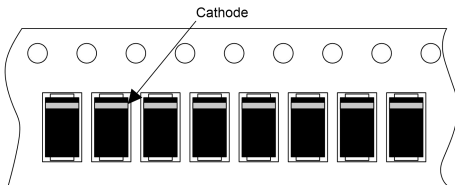

### 13 Inches Reel



Quantity: 5000pcs/reel