

Subminiature Basic Switch Offers High Reliability and Security

- The OMRON's best-selling micro switches of a wide variety from 0.1A to 10.1A.
- A variety of models are available, with operating force ranging from low to high.
- Two split springs ensure a high stability and durability of 30,000,000 operations.
- 1 mm MIN Contact Gap Models available for Interlock applications

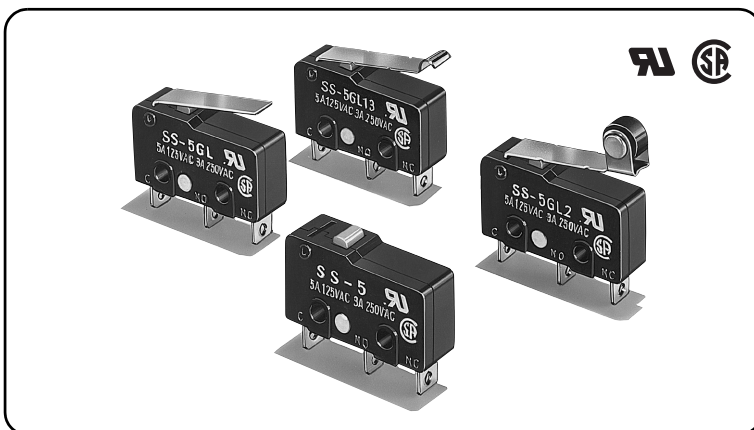

SS

RoHS Compliant

Model Number Legend

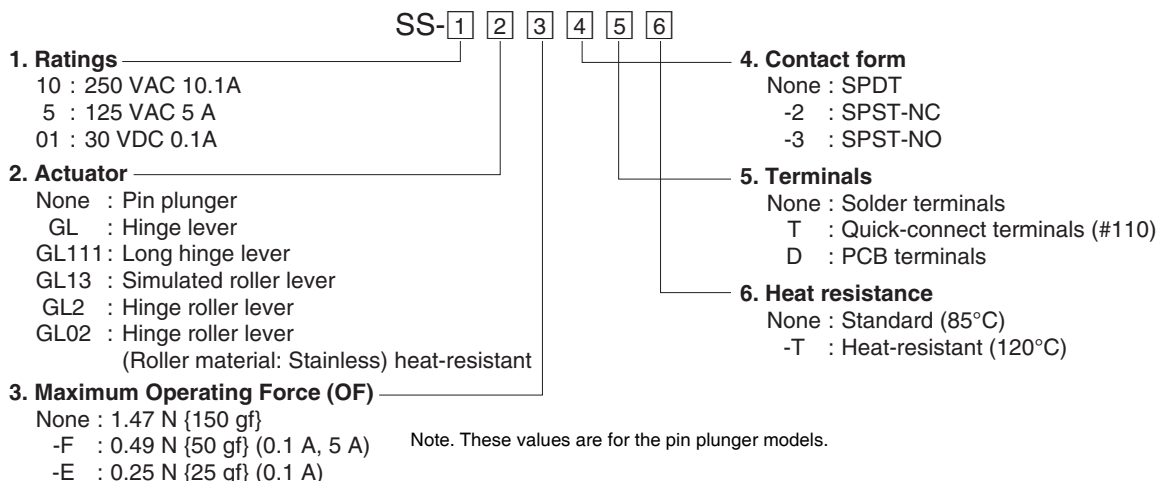



List of Models

●Standard Models

| Actuator | Terminals | Contact Form | Maximum Operating Force (OF) | Ratings | | |
|--|--------------------------------|--------------|------------------------------|----------|------------|------------|
| | | | | 10.1 A | 5 A | 0.1 A |
| Pin plunger  | Solder terminals | SPDT | 1.47 N {150 gf} | SS-10 | SS-5 | SS-01 |
| | | SPST-NC | | SS-10-2 | SS-5-2 | SS-01-2 |
| | | SPST-NO | | SS-10-3 | SS-5-3 | SS-01-3 |
| | Quick-connect terminals (#110) | SPDT | | SS-10T | SS-5T | SS-01T |
| | | SPST-NC | | SS-10-2T | SS-5-2T | SS-01-2T |
| | | SPST-NO | | SS-10-3T | SS-5-3T | SS-01-3T |
| | PCB terminals | SPDT | | SS-10D | SS-5D | SS-01D |
| | | SPST-NC | | SS-10-2D | SS-5-2D | SS-01-2D |
| | | SPST-NO | | SS-10-3D | SS-5-3D | SS-01-3D |
| | Solder terminals | SPDT | 0.49 N {50 gf} | - | SS-5-F | SS-01-F |
| | | SPST-NC | | - | SS-5-F-2 | SS-01-F-2 |
| | | SPST-NO | | - | SS-5-F-3 | SS-01-F-3 |
| | Quick-connect terminals (#110) | SPDT | | - | SS-5-FT | SS-01-FT |
| | | SPST-NC | | - | SS-5-F-2T | SS-01-F-2T |
| | | SPST-NO | | - | SS-5-F-3T | SS-01-F-3T |
| | PCB terminals | SPDT | | - | SS-5-FD | SS-01-FD |
| | | SPST-NC | | - | SS-5-F-2D | SS-01-F-2D |
| | | SPST-NO | | - | SS-5-F-3D | SS-01-F-3D |
| | Solder terminals | SPDT | 0.25 N {25 gf} | - | - | SS-01-E |
| | | SPST-NC | | - | - | SS-01-E-2 |
| | | SPST-NO | | - | - | SS-01-E-3 |
| | Quick-connect terminals (#110) | SPDT | | - | - | SS-01-ET |
| | | SPST-NC | | - | - | SS-01-E-2T |
| | | SPST-NO | | - | - | SS-01-E-3T |
| PCB terminals | SPDT | - | | - | SS-01-ED | |
| | SPST-NC | - | | - | SS-01-E-2D | |
| | SPST-NO | - | | - | SS-01-E-3D | |

Separator (Sold Separately), Terminal Connector (Sold Separately) ➔ Refer to "Basic Switch Common Accessories"

| Actuator | Terminals | Contact Form | Maximum Operating Force (OF) | Ratings | | |
|---|--------------------------------|--------------|------------------------------|---------------|----------------|-----------------|
| | | | | 10.1 A | 5 A | 0.1 A |
|  <p>Hinge lever</p> | Solder terminals | SPDT | 0.49 N {50 gf} | SS-10GL | SS-5GL | SS-01GL |
| | | SPST-NC | | SS-10GL-2 | SS-5GL-2 | SS-01GL-2 |
| | | SPST-NO | | SS-10GL-3 | SS-5GL-3 | SS-01GL-3 |
| | Quick-connect terminals (#110) | SPDT | | SS-10GLT | SS-5GLT | SS-01GLT |
| | | SPST-NC | | SS-10GL-2T | SS-5GL-2T | SS-01GL-2T |
| | | SPST-NO | | SS-10GL-3T | SS-5GL-3T | SS-01GL-3T |
| | PCB terminals | SPDT | | SS-10GLD | SS-5GLD | SS-01GLD |
| | | SPST-NC | | SS-10GL-2D | SS-5GL-2D | SS-01GL-2D |
| | | SPST-NO | | SS-10GL-3D | SS-5GL-3D | SS-01GL-3D |
| | Solder terminals | SPDT | 0.16 N {16 gf} | - | SS-5GL-F | SS-01GL-F |
| | | SPST-NC | | - | SS-5GL-F-2 | SS-01GL-F-2 |
| | | SPST-NO | | - | SS-5GL-F-3 | SS-01GL-F-3 |
| | Quick-connect terminals (#110) | SPDT | | - | SS-5GL-FT | SS-01GL-FT |
| | | SPST-NC | | - | SS-5GL-F-2T | SS-01GL-F-2T |
| | | SPST-NO | | - | SS-5GL-F-3T | SS-01GL-F-3T |
| | PCB terminals | SPDT | | - | SS-5GL-FD | SS-01GL-FD |
| | | SPST-NC | | - | SS-5GL-F-2D | SS-01GL-F-2D |
| | | SPST-NO | | - | SS-5GL-F-3D | SS-01GL-F-3D |
| | Solder terminals | SPDT | 0.08 N {8 gf} | - | - | SS-01GL-E |
| | | SPST-NC | | - | - | SS-01GL-E-2 |
| | | SPST-NO | | - | - | SS-01GL-E-3 |
| | Quick-connect terminals (#110) | SPDT | | - | - | SS-01GL-ET |
| | | SPST-NC | | - | - | SS-01GL-E-2T |
| | | SPST-NO | | - | - | SS-01GL-E-3T |
| | PCB terminals | SPDT | | - | - | SS-01GL-ED |
| | | SPST-NC | | - | - | SS-01GL-E-2D |
| | | SPST-NO | | - | - | SS-01GL-E-3D |
|  <p>Long hinge lever</p> | Solder terminals | SPDT | 0.39 N {40 gf} | SS-10GL111 | SS-5GL111 | SS-01GL111 |
| | | SPST-NC | | SS-10GL111-2 | SS-5GL111-2 | SS-01GL111-2 |
| | | SPST-NO | | SS-10GL111-3 | SS-5GL111-3 | SS-01GL111-3 |
| | Quick-connect terminals (#110) | SPDT | | SS-10GL111T | SS-5GL111T | SS-01GL111T |
| | | SPST-NC | | SS-10GL111-2T | SS-5GL111-2T | SS-01GL111-2T |
| | | SPST-NO | | SS-10GL111-3T | SS-5GL111-3T | SS-01GL111-3T |
| | PCB terminals | SPDT | | SS-10GL111D | SS-5GL111D | SS-01GL111D |
| | | SPST-NC | | SS-10GL111-2D | SS-5GL111-2D | SS-01GL111-2D |
| | | SPST-NO | | SS-10GL111-3D | SS-5GL111-3D | SS-01GL111-3D |
| | Solder terminals | SPDT | 0.12 N {12 gf} | - | SS-5GL111-F | SS-01GL111-F |
| | | SPST-NC | | - | SS-5GL111-F-2 | SS-01GL111-F-2 |
| | | SPST-NO | | - | SS-5GL111-F-3 | SS-01GL111-F-3 |
| | Quick-connect terminals (#110) | SPDT | | - | SS-5GL111-FT | SS-01GL111-FT |
| | | SPST-NC | | - | SS-5GL111-F-2T | SS-01GL111-F-2T |
| | | SPST-NO | | - | SS-5GL111-F-3T | SS-01GL111-F-3T |
| | PCB terminals | SPDT | | - | SS-5GL111-FD | SS-01GL111-FD |
| | | SPST-NC | | - | SS-5GL111-F-2D | SS-01GL111-F-2D |
| | | SPST-NO | | - | SS-5GL111-F-3D | SS-01GL111-F-3D |
| | Solder terminals | SPDT | 0.06 N {6 gf} | - | - | SS-01GL111-E |
| | | SPST-NC | | - | - | SS-01GL111-E-2 |
| | | SPST-NO | | - | - | SS-01GL111-E-3 |
| | Quick-connect terminals (#110) | SPDT | | - | - | SS-01GL111-ET |
| | | SPST-NC | | - | - | SS-01GL111-E-2T |
| | | SPST-NO | | - | - | SS-01GL111-E-3T |
| | PCB terminals | SPDT | | - | - | SS-01GL111-ED |
| | | SPST-NC | | - | - | SS-01GL111-E-2D |
| | | SPST-NO | | - | - | SS-01GL111-E-3D |
|  <p>Simulated roller lever</p> | Solder terminals | SPDT | 0.49 N {50 gf} | SS-10GL13 | SS-5GL13 | SS-01GL13 |
| | | SPST-NC | | SS-10GL13-2 | SS-5GL13-2 | SS-01GL13-2 |
| | | SPST-NO | | SS-10GL13-3 | SS-5GL13-3 | SS-01GL13-3 |
| | Quick-connect terminals (#110) | SPDT | | SS-10GL13T | SS-5GL13T | SS-01GL13T |
| | | SPST-NC | | SS-10GL13-2T | SS-5GL13-2T | SS-01GL13-2T |
| | | SPST-NO | | SS-10GL13-3T | SS-5GL13-3T | SS-01GL13-3T |
| | PCB terminals | SPDT | | SS-10GL13D | SS-5GL13D | SS-01GL13D |
| | | SPST-NC | | SS-10GL13-2D | SS-5GL13-2D | SS-01GL13-2D |
| | | SPST-NO | | SS-10GL13-3D | SS-5GL13-3D | SS-01GL13-3D |
| | Solder terminals | SPDT | 0.16 N {16 gf} | - | SS-5GL13-F | SS-01GL13-F |
| | | SPST-NC | | - | SS-5GL13-F-2 | SS-01GL13-F-2 |
| | | SPST-NO | | - | SS-5GL13-F-3 | SS-01GL13-F-3 |
| | Quick-connect terminals (#110) | SPDT | | - | SS-5GL13-FT | SS-01GL13-FT |
| | | SPST-NC | | - | SS-5GL13-F-2T | SS-01GL13-F-2T |
| | | SPST-NO | | - | SS-5GL13-F-3T | SS-01GL13-F-3T |
| | PCB terminals | SPDT | | - | SS-5GL13-FD | SS-01GL13-FD |
| | | SPST-NC | | - | SS-5GL13-F-2D | SS-01GL13-F-2D |
| | | SPST-NO | | - | SS-5GL13-F-3D | SS-01GL13-F-3D |
| | Solder terminals | SPDT | 0.08 N {8 gf} | - | - | SS-01GL13-E |
| | | SPST-NC | | - | - | SS-01GL13-E-2 |
| | | SPST-NO | | - | - | SS-01GL13-E-3 |
| | Quick-connect terminals (#110) | SPDT | | - | - | SS-01GL13-ET |
| | | SPST-NC | | - | - | SS-01GL13-E-2T |
| | | SPST-NO | | - | - | SS-01GL13-E-3T |
| | PCB terminals | SPDT | | - | - | SS-01GL13-ED |
| | | SPST-NC | | - | - | SS-01GL13-E-2D |
| | | SPST-NO | | - | - | SS-01GL13-E-3D |

Separator (Sold Separately), Terminal Connector (Sold Separately) ➔ Refer to "Basic Switch Common Accessories"

| Actuator | Terminals | Contact Form | Maximum Operating Force (OF) | Ratings | | |
|---|--------------------------------|--------------|------------------------------|-------------|---------------|---------------|
| | | | | 10.1 A | 5 A | 0.1 A |
| Hinge roller lever  | Solder terminals | SPDT | 0.49 N {50 gf} | SS-10GL2 | SS-5GL2 | SS-01GL2 |
| | | SPST-NC | | SS-10GL2-2 | SS-5GL2-2 | SS-01GL2-2 |
| | | SPST-NO | | SS-10GL2-3 | SS-5GL2-3 | SS-01GL2-3 |
| | Quick-connect terminals (#110) | SPDT | | SS-10GL2T | SS-5GL2T | SS-01GL2T |
| | | SPST-NC | | SS-10GL2-2T | SS-5GL2-2T | SS-01GL2-2T |
| | | SPST-NO | | SS-10GL2-3T | SS-5GL2-3T | SS-01GL2-3T |
| | PCB terminals | SPDT | | SS-10GL2D | SS-5GL2D | SS-01GL2D |
| | | SPST-NC | | SS-10GL2-2D | SS-5GL2-2D | SS-01GL2-2D |
| | | SPST-NO | | SS-10GL2-3D | SS-5GL2-3D | SS-01GL2-3D |
| | Solder terminals | SPDT | 0.16 N {16 gf} | - | SS-5GL2-F | SS-01GL2-F |
| | | SPST-NC | | - | SS-5GL2-F-2 | SS-01GL2-F-2 |
| | | SPST-NO | | - | SS-5GL2-F-3 | SS-01GL2-F-3 |
| | Quick-connect terminals (#110) | SPDT | | - | SS-5GL2-FT | SS-01GL2-FT |
| | | SPST-NC | | - | SS-5GL2-F-2T | SS-01GL2-F-2T |
| | | SPST-NO | | - | SS-5GL2-F-3T | SS-01GL2-F-3T |
| | PCB terminals | SPDT | | - | SS-5GL2-FD | SS-01GL2-FD |
| | | SPST-NC | | - | SS-5GL2-F-2D | SS-01GL2-F-2D |
| | | SPST-NO | | - | SS-5GL2-F-3D | SS-01GL2-F-3D |
| | Solder terminals | SPDT | 0.08 N {8 gf} | - | - | SS-01GL2-E |
| | | SPST-NC | | - | - | SS-01GL2-E-2 |
| | | SPST-NO | | - | - | SS-01GL2-E-3 |
| | Quick-connect terminals (#110) | SPDT | | - | - | SS-01GL2-ET |
| | | SPST-NC | | - | - | SS-01GL2-E-2T |
| | | SPST-NO | | - | - | SS-01GL2-E-3T |
| PCB terminals | SPDT | - | | - | SS-01GL2-ED | |
| | SPST-NC | - | | - | SS-01GL2-E-2D | |
| | SPST-NO | - | | - | SS-01GL2-E-3D | |

Heat Resistant Models

| Actuator | Terminals | Contact Form | Maximum Operating Force (OF) | Ratings | | |
|--|--------------------------------|----------------|------------------------------|---------------|--------------|---------------|
| | | | | 10.1 A | 5 A | 0.1 A |
| Pin plunger  | Solder terminals | SPDT | 1.47 N {150 gf} | SS-10-T | SS-5-T | SS-01-T |
| | Quick-connect terminals (#110) | | | SS-10T-T | SS-5T-T | SS-01T-T |
| | PCB terminals | | | SS-10D-T | SS-5D-T | SS-01D-T |
| Hinge lever  | Solder terminals | | 0.49 N {50 gf} | SS-10GL-T | SS-5GL-T | SS-01GL-T |
| | Quick-connect terminals (#110) | | | SS-10GLT-T | SS-5GLT-T | SS-01GLT-T |
| | PCB terminals | | | SS-10GLD-T | SS-5GLD-T | SS-01GLD-T |
| Long hinge lever  | Solder terminals | | 0.39 N {40 gf} | SS-10GL111-T | SS-5GL111-T | SS-01GL111-T |
| | Quick-connect terminals (#110) | | | SS-10GL111T-T | SS-5GL111T-T | SS-01GL111T-T |
| | PCB terminals | | | SS-10GL111D-T | SS-5GL111D-T | SS-01GL111D-T |
| Simulated roller lever  | Solder terminals | 0.49 N {50 gf} | SS-10GL13-T | SS-5GL13-T | SS-01GL13-T | |
| | Quick-connect terminals (#110) | | SS-10GL13T-T | SS-5GL13T-T | SS-01GL13T-T | |
| | PCB terminals | | SS-10GL13D-T | SS-5GL13D-T | SS-01GL13D-T | |
| Hinge roller lever (Roller material: stainless steel)  | Solder terminals | 0.49 N {50 gf} | SS-10GL02-T | SS-5GL02-T | SS-01GL02-T | |
| | Quick-connect terminals (#110) | | SS-10GL02T-T | SS-5GL02T-T | SS-01GL02T-T | |
| | PCB terminals | | SS-10GL02D-T | SS-5GL02D-T | SS-01GL02D-T | |

1 mm MIN Contact Gap Models

| Actuator | Terminals | Contact Form | Maximum Operating Force (OF) | Ratings | | |
|---|--------------------------------|--------------|------------------------------|---------|--------------|-------|
| | | | | 10.1 A | 5 A | 0.1 A |
| Long hinge lever  | Solder terminals | SPST-NO | 0.54 N {55 gf} | - | SS-5FL111-3 | - |
| | Quick-connect terminals (#110) | | | - | SS-5FL111-3T | - |

Contact Form

SPDT

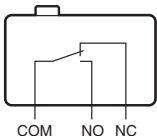

SPST-NC

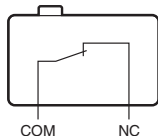

SPST-NO

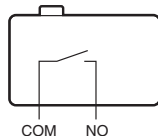

Contact Specifications

| Item | Model | SS-10 models | SS-5 models | SS-01 models | SS-5F models |
|--|----------------------|--------------|-------------|--------------|--------------|
| Contact | Specification | Rivet | | Crossbar | Rivet |
| | Material | Silver alloy | Silver | Gold alloy | Silver |
| | Gap (standard value) | 0.5 mm | | 0.25 mm | 1mm min. |
| Inrush current | NC | 20 A max. | | 1 A max. | - |
| | NO | 15 A max. | 10 A max. | 1 A max. | 10 A max. |
| Minimum applicable load (reference value)* | | 5 VDC 160 mA | | 5 VDC 1 mA | 5 VDC 160 mA |

* Please refer to "Using Micro Loads" in "Precautions" for more information on the minimum applicable load.

Separator (Sold Separately), Terminal Connector (Sold Separately) ➔ Refer to "Basic Switch Common Accessories"

Ratings

| Model | Item Rated voltage | Resistive load |
|--------------|--------------------|----------------|
| SS-10 models | 250 VAC | 10.1 A |
| SS-5 models | 125 VAC | 5 A |
| | 250 VAC | 3 A |
| SS-01 models | 125 VAC | 0.1 A |
| | 30 VDC | 0.1 A |
| SS-5F models | 250 VAC | 3 A |
| | 30 VDC | 5 A |

Note. The above rating values apply under the following test conditions.
 (1) Ambient temperature: 20±2°C
 (2) Ambient humidity: 65±5%
 (3) Operating frequency: 30 operations/min

Approved Safety Standards

Models shown in the "List of Models" are UL and CSA approved models.

Note. Note that heat resistant models are not standard approved models.

UL (UL1054)/CSA (CSA C22.2 No.55)

| Model Rated voltage | SS-10 | SS-5 | SS-01 | SS-5F |
|---------------------|-------|------|-------|-------|
| 125 VAC | - | 5 A | 0.1 A | - |
| 250 VAC | 10.1A | 3 A | - | 3 A |
| 30 VDC | - | - | 0.1 A | 5 A |

Consult your OMRON sales representative for specific models with VDE standard approvals.
VDE (EN61058-1)

| Model Rated voltage | SS-10 | SS-5 | SS-5F |
|---------------------|-------|------|-------|
| 250 VAC | 10 A | 5 A | 3 A |

Testing conditions: 5E4 (50,000 operations)
 T85 (0°C to 85°C)

Characteristics

| Item | Model | SS-10 models | SS-5 models | SS-01 models | SS-5F models |
|---|---|--|--|---|---|
| Permissible operating speed | | 0.1 mm to 1 m/s (for pin plunger models) | | | |
| Permissible operating frequency | Mechanical | 400 operations/min | | | |
| | Electrical | 60 operations/min | | | |
| Insulation resistance | | 100 MΩ min. (at 500 VDC with insulation tester) | | | |
| Contact resistance (initial value) | OF 1.47 N models | 30 mΩ max. | | 50 mΩ max. | 30 mΩ max. |
| | OF 0.49 N models | - | 50 mΩ max. | 100 mΩ max. | - |
| | OF 0.25 N models | - | - | 150 mΩ max. | - |
| Dielectric strength *1 | Between terminals of the same polarity | 1,000 VAC 50/60 Hz for 1 min | | 600 VAC 50/60 Hz for 1 min | 1,000 VAC 50/60 Hz for 1 min |
| | Between current-carrying metal parts and ground | 1,500 VAC 50/60 Hz for 1 min | | | |
| | Between each terminals and non-current-carrying metal parts | 1,500 VAC 50/60 Hz for 1 min | | | |
| Vibration resistance *2 | Malfunction | 10 to 55 Hz, 1.5 mm double amplitude | | | |
| Shock resistance | Durability | OF 1.47 N models | 1,000 m/s ² {approx. 100G} max. | | - |
| | | OF 0.49 N models | 500 m/s ² {approx. 50G} max. | | - |
| | | OF 0.25 N models | 500 m/s ² {approx. 50G} max. | | - |
| | Malfunction *2 | OF 1.47 N models | 300 m/s ² {approx. 30G} max. | | - |
| | | OF 0.49 N models | 200 m/s ² {approx. 20G} max. | | - |
| Durability *3 | Mechanical | 10,000,000 operations min. (60 operations/min) | 30,000,000 operations min. (60 operations/min) | 100,000 operations min. (60 operations/min) | 100,000 operations min. (60 operations/min) |
| | Electrical | 50,000 operations min. (30 operations/min) | 200,000 operations min. (30 operations/min) | 100,000 operations min. (30 operations/min) | 100,000 operations min. (30 operations/min) |
| Degree of protection | | IEC IP40 | | | |
| Degree of protection against electric shock | | Class I | | | |
| Proof tracking index (PTI) | | 175 | | | |
| Ambient operating temperature | | -25°C to +85°C (at ambient humidity of 60% max.) (with no icing or condensation) | | | |
| Ambient operating humidity | | 85% max. (for +5°C to +35°C) | | | |
| Weight | | Approx. 1.6g (pin plunger models) | | | |

Note. The data given above are initial values.

- *1. The values for dielectric strength shown are for models with a Separator (refer to "Micro Switch Common Accessories").
- *2. The values are at Free Position and Total Travel Position values for pin plunger, and Total Travel Position value for lever. Close or open circuit of the contact is 1ms max.
- *3. For testing conditions, consult your OMRON sales representative.

Terminals/Appearances (Unit: mm)

●Solder terminals

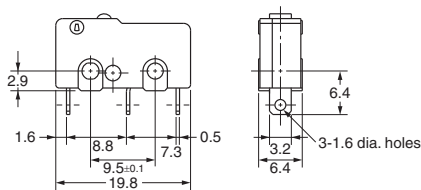

●Quick connect terminals (#110)

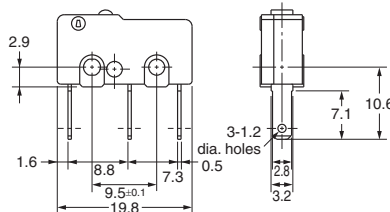

●PCB terminals

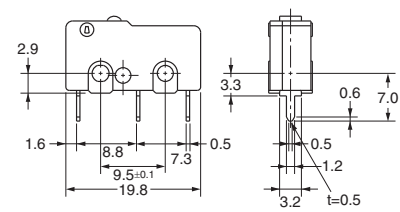

<PCB Mounting Dimensions (Reference)>

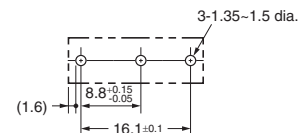

Note. SPST-NO terminal models do not have NC terminal.

Mounting Holes (Unit: mm)

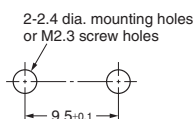

Dimensions (Unit: mm) and Operating Characteristics

The illustrations and drawings are for solder terminals models.

Refer to "Terminals/Appearances" of the previous page for details on models with quick connect terminals (#110) or PCB terminals.

●Pin plunger

- SS-10
- SS-5 (-F)
- SS-01 (-E, -F)

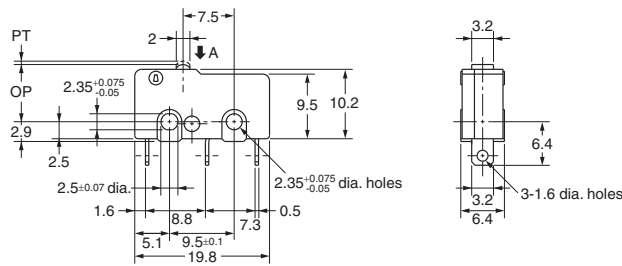
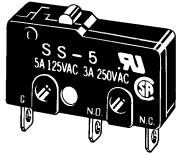

| Model | | SS-10 | SS-5 SS-01 | SS-5-F SS-01-F | SS-01-E |
|---------------------------|----|----------------------|-----------------|-------------------|----------------|
| Operating Characteristics | | | | | |
| Operating Force | OF | Max. 1.47 N {150 gf} | 1.47 N {150 gf} | 0.49 N {50 gf} | 0.25 N {25 gf} |
| Releasing Force | RF | Min. 0.25 N {25 gf} | 0.25 N {25 gf} | 0.04 N {4 gf} | 0.02 N {2 gf} |
| Pretravel | PT | Max. 0.6 mm | 0.5 mm | 0.5 mm | 0.5 mm |
| Overtravel | OT | Min. 0.4 mm | 0.5 mm | 0.5 mm | 0.5 mm |
| Movement Differential | MD | Max. 0.12 mm | 0.1 mm | 0.1 mm | 0.1 mm |
| Operating Position | OP | 8.4±0.5 mm | | | |

●Hinge lever

- SS-10GL
- SS-5GL (-F)
- SS-01GL (-E, -F)

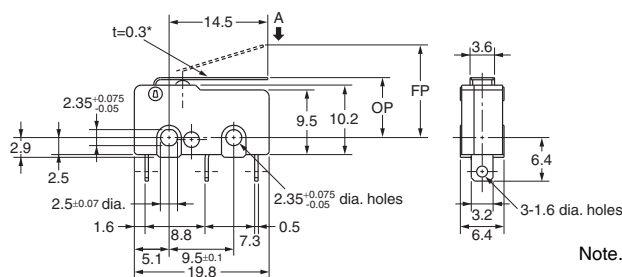

Note. The indicated reference values of RF are for cases where the lever weight is not applied to the plunger.

* Stainless-steel lever

| Model | | SS-10GL | SS-5GL SS-01GL | SS-5GL-F SS-01GL-F | SS-01GL-E |
|---------------------------|----|---------------------|-------------------|-----------------------|------------------------------------|
| Operating Characteristics | | | | | |
| Operating Force | OF | Max. 0.49 N {50 gf} | 0.49 N {50 gf} | 0.16 N {16 gf} | 0.08 N {8 gf} |
| Releasing Force | RF | Min. 0.06 N {6 gf} | 0.06 N {6 gf} | 0.02 N {2 gf} | 0.01 N {1 gf} (reference value) |
| Overtravel | OT | Min. 1.0 mm | 1.2 mm | 1.2 mm | 1.2 mm |
| Movement Differential | MD | Max. 1.0 mm | 0.8 mm | 0.8 mm | 0.8 mm |
| Free Position | FP | Max. 13.6 mm | | | |
| Operating Position | OP | 8.8±0.8 mm | | | |

●Long hinge lever

- SS-10GL111
- SS-5GL111 (-F)
- SS-01GL111 (-E, -F)
- SS-5FL111-3

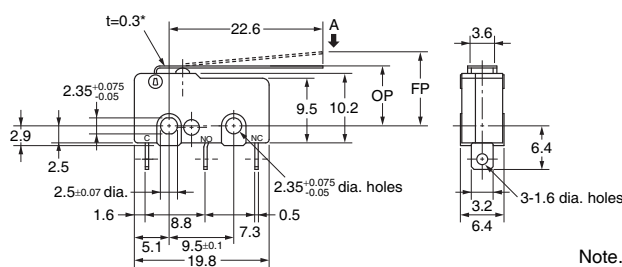
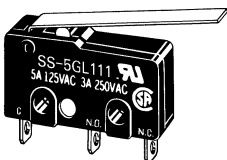

Note. The indicated reference values of RF are for cases where the lever weight is not applied to the plunger.

* Stainless-steel lever

| Model | | SS-10GL111 | SS-5GL111 SS-01GL111 | SS-5FL111-3 | SS-5GL111-F SS-01GL111-F | SS-01GL111-E |
|---------------------------|----|---------------------|-------------------------|----------------|------------------------------------|---------------------------------------|
| Operating Characteristics | | | | | | |
| Operating Force | OF | Max. 0.39 N {40 gf} | 0.39 N {40 gf} | 0.54 N {55 gf} | 0.12 N {12 gf} | 0.06 N {6 gf} |
| Releasing Force | RF | Min. 0.03 N {3 gf} | 0.03 N {3 gf} | 0.01 N {1 gf} | 0.02 N {2 gf} (reference value) | 0.003 N {0.3 gf} (reference value) |
| Overtravel | OT | Min. 1.2 mm | 1.2 mm | 1.0 mm | 1.2 mm | 1.2 mm |
| Movement Differential | MD | Max. 1.2 mm | 1.2 mm | 3.0 mm | 1.2 mm | 1.2 mm |
| Free Position | FP | Max. 16.8 mm | | | | |
| Operating Position | OP | 8.8±1.5 mm | | | | 8.8±2 mm |

Note 1. Unless otherwise specified, a tolerance of ±0.4 mm applies to all dimensions.

Note 2. The operating characteristics are for operation in the A direction (↓).

● Simulated roller lever

SS-10GL13
SS-5GL13 (-F)
SS-01GL13 (-E, -F)

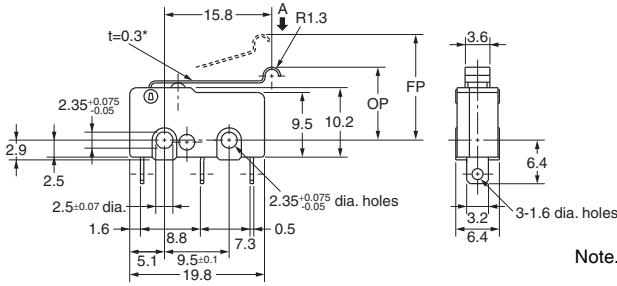
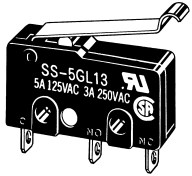

* Stainless-steel lever

Note. The indicated reference values of RF are for cases where the lever weight is not applied to the plunger.

| Operating Characteristics | | Model | SS-10GL13 | SS-5GL13 SS-01GL13 | SS-5GL13-F SS-01GL13-F | SS-01GL13-E |
|---------------------------|-----------------|-------|----------------|-----------------------|---------------------------|------------------------------------|
| Operating Force | OF | Max. | 0.49 N {50 gf} | 0.49 N {50 gf} | 0.16 N {16 gf} | 0.08 N {8 gf} |
| | Releasing Force | RF | Min. | 0.06 N {6 gf} | 0.02 N {2 gf} | 0.01 N {1 gf} (reference value) |
| Overtravel | OT | Min. | 1.0 mm | 1.2 mm | 1.2 mm | 1.2 mm |
| Movement Differential | MD | Max. | 1.0 mm | 0.8 mm | 0.8 mm | 0.8 mm |
| Free Position | FP | Max. | 15.5 mm | | | |
| Operating Position | OP | | 10.7±0.8 mm | | | |

● Hinge roller lever

SS-10GL2
SS-5GL2 (-F)
SS-01GL2 (-E, -F)

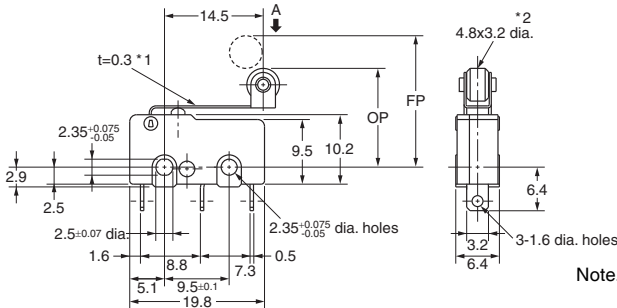
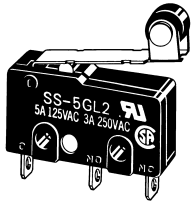

*1. Stainless-steel lever
*2. Polyacetal resin roller

Note. The indicated reference values of RF are for cases where the lever weight is not applied to the plunger.

| Operating Characteristics | | Model | SS-10GL2 | SS-5GL2 SS-01GL2 | SS-5GL2-F SS-01GL2-F | SS-01GL2-E |
|---------------------------|-----------------|-------|----------------|---------------------|-------------------------|------------------------------------|
| Operating Force | OF | Max. | 0.49 N {50 gf} | 0.49 N {50 gf} | 0.16 N {16 gf} | 0.08 N {8 gf} |
| | Releasing Force | RF | Min. | 0.06 N {6 gf} | 0.02 N {2 gf} | 0.01 N {1 gf} (reference value) |
| Overtravel | OT | Min. | 1.0 mm | 1.2 mm | 1.2 mm | 1.2 mm |
| Movement Differential | MD | Max. | 1.0 mm | 0.8 mm | 0.8 mm | 0.8 mm |
| Free Position | FP | Max. | 19.3mm | | | |
| Operating Position | OP | | 14.5±0.8mm | | | |

Note 1. Unless otherwise specified, a tolerance of ±0.4 mm applies to all dimensions.

Note 2. The operating characteristics are for operation in the A direction (↓).

Precautions

★Please refer to "Common Precautions" for correct use.

Cautions

●Soldering

- Complete the soldering at the iron tip temperature below 350°C within 5 seconds, and do not apply any external force for 1 minute after soldering. Soldering at an excessively high temperature or soldering for more than 5 seconds may deteriorate the characteristics of the Switch.
- Be sure to apply only the minimum required amount of flux. Switch may have contact failures if flux intrudes into the interior of the Switch.
- If the PCB terminal models are soldered in the solder bath, flux will permeate inside the Switch and cause contact failure. Therefore, manually solder the PCB terminal.

Correct Use

●Mounting

- Use M2.3 mounting screw with plane washers or spring washers to securely mount the Switch. Tighten the screws to a torque of 0.23 to 0.26 N·m {2.3 to 2.7 kgf·cm}.
- Mount the Switch onto a flat surface. Mounting on an uneven surface may cause deformation of the Switch, resulting in faulty operation or breakage in the housing.

●Using Micro Loads

Using a model for ordinary loads to open or close the contact of a micro load circuit may result in faulty contact. Use models that operate in the following range. However, even when using micro load models within the following operating range, if inrush current occurs when the contact is opened or closed, it may increase the contact wear and so decrease durability. Therefore, insert a contact protection circuit where necessary. The N-level reference value applies for the minimum applicable load. This value indicates the malfunction reference level for the reliability level of 60% (λ_{60}).

(JIS C5003)

The equation, $\lambda_{60}=0.5 \times 10^{-6} / \text{operation}$ indicates that the estimated malfunction rate is less than $\frac{1}{2,000,000}$ operations with a reliability level of 60%.

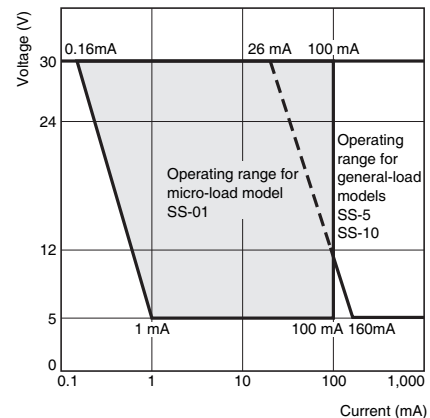

- Application examples provided in this document are for reference only. In actual applications, confirm equipment functions and safety before using the product.
- Consult your OMRON representative before using the product under conditions which are not described in the manual or applying the product to nuclear control systems, railroad systems, aviation systems, vehicles, combustion systems, medical equipment, amusement machines, safety equipment, and other systems or equipment that may have a serious influence on lives and property if used improperly. Make sure that the ratings and performance characteristics of the product provide a margin of safety for the system or equipment, and be sure to provide the system or equipment with double safety mechanisms.

Note: Do not use this document to operate the Unit.