



FEATURES:

- Over Voltage Protection
- Wide 4:1 input range
- High efficiency up to 88%
- Over current Protection
- Under voltage lockout
- Very low no load power consumption of 0.12W
- Input / Output Isolation 1500, 3000 & 6000VDC
- Continuous short circuit protection
- 1.5KV isolation models design to meet EN50155
- 6KV isolation models design to meet EN60601-1 3rd, 2xMOPP, Type CF applied part

Models
Single output



Model	Input Voltage (V)	Output Voltage (V)	Output Current max (mA)	Max. Capacitive Load (µF)	Isolation (VDC)	Efficiency (%)
AM6TW-2403S-NZ	9-36	3.3	1500	1800	1500	79
AM6TW-2405S-NZ	9-36	5	1200	1000	1500	83
AM6TW-2412S-NZ	9-36	12	500	470	1500	87
AM6TW-2415S-NZ	9-36	15	400	220	1500	88
AM6TW-2424S-NZ	9-36	24	250	100	1500	87
AM6TW-4803S-NZ	18-75	3.3	1500	1800	1500	80
AM6TW-4805S-NZ	18-75	5	1200	1000	1500	84
AM6TW-4812S-NZ	18-75	12	500	470	1500	87
AM6TW-4815S-NZ	18-75	15	400	220	1500	88
AM6TW-4824S-NZ	18-75	24	250	100	1500	87
AM6TW-2403SH30-NZ	9-36	3.3	1500	2200	3000	77
AM6TW-2405SH30-NZ	9-36	5	1200	2200	3000	80
AM6TW-2409SH30-NZ	9-36	9	667	1000	3000	85
AM6TW-2412SH30-NZ	9-36	12	500	680	3000	83
AM6TW-2415SH30-NZ	9-36	15	400	680	3000	85
AM6TW-2424SH30-NZ	9-36	24	250	680	3000	85
AM6TW-4803SH30-NZ	18-75	3.3	1500	2200	3000	78
AM6TW-4805SH30-NZ	18-75	5	1200	2200	3000	81
AM6TW-4812SH30-NZ	18-75	12	500	680	3000	87
AM6TW-4815SH30-NZ	18-75	15	400	680	3000	86
AM6TW-4824SH30-NZ	18-75	24	250	680	3000	87
AM6TW-2405SH60-NZ#	9-36	5	1200	2700	6000	80
AM6TW-2406SH60-NZ	9-36	6	1000	2200	6000	81
AM6TW-2409SH60-NZ	9-36	9	667	1800	6000	83
AM6TW-2412SH60-NZ#	9-36	12	500	1000	6000	84
AM6TW-2415SH60-NZ	9-36	15	400	680	6000	85
AM6TW-2424SH60-NZ	9-36	24	250	470	6000	84
AM6TW-4805SH60-NZ#	18-75	5	1200	2700	6000	81
AM6TW-4809SH60-NZ	18-75	9	667	1800	6000	83
AM6TW-4812SH60-NZ	18-75	12	500	1000	6000	84
AM6TW-4815SH60-NZ	18-75	15	400	680	6000	85
AM6TW-4824SH60-NZ	18-75	24	250	470	6000	84

Models
Dual output

Model	Input Voltage (V)	Output Voltage (V)	Output Current max (mA)	Max. Capacitive Load (µF)	Isolation (VDC)	Efficiency (%)
AM6TW-2405D-NZ	9-36	±5	±600	±680	1500	83
AM6TW-2409D-NZ	9-36	±9	±333	±220	1500	86
AM6TW-2412D-NZ	9-36	±12	±250	±330	1500	87
AM6TW-2415D-NZ	9-36	±15	±200	±220	1500	88
AM6TW-2424D-NZ	9-36	±24	±125	±100	1500	87

AM6TW-4805D-NZ	18-75	±5	±600	±680	1500	83
AM6TW-4812D-NZ	18-75	±12	±250	±330	1500	87
AM6TW-4815D-NZ	18-75	±15	±200	±220	1500	88
AM6TW-2405DH30-NZ	9-36	±5	±600	±680	3000	80
AM6TW-2412DH30-NZ	9-36	±12	±250	±330	3000	84
AM6TW-2415DH30-NZ	9-36	±15	±200	±220	3000	84

Input Specifications

Parameters	Nominal	Typical	Maximum	Units
Voltage range	24 Vin	9-36		VDC
	48 Vin	18-75		VDC
Absolute Maximum Input Voltage (1 Sec max)	24 Vin		-0.7 - 50	VDC
	48 Vin		-0.7 - 100	VDC
Filter	π (Pi) Network			
Reflected Input ripple current		20		mA p-p
Input Under Voltage lockout	24 Vin	6.5		VDC
	48 Vin	15.5		VDC
Startup voltage	24 Vin		9	VDC
	48 Vin		18	VDC
Startup time	3000VDC isolated models	10		ms

Isolation Specifications

Parameters	Conditions	Typical	Maximum	Units
Tested I/O voltage	60 sec, <1mA, 1500VDC isolated models	≥ 1500		VDC
	60 sec, <1mA, 3000VDC isolated models	≥ 3000		VDC
	60 sec, <1mA, 6000VDC isolated models	≥ 6000		VDC
Resistance	1500 & 3000VDC isolated models, 500VDC	≥ 1000		MOhm
	6000VDC isolated models, 500VDC	≥ 10000		MOhm
Capacitance (0.1V/100KHz)	1500 & 3000VDC isolated models	1000		pF
	6000VDC isolated models	13	20	pF
Isolation creepage and clearances (6000VDC isolated models)	PCB Clearance and Creepage	≥ 8.0		mm
	Optocoupler Creepage	≥ 8.0		mm
	Transformer Creepage	≥ 8.0		mm
	Transformer Clearance	≥ 5.0		mm
Insulation system	6000VDC isolated models	Reinforced isolation		
Leakage	6000VDC isolated models, 240VAC/60Hz	3.6	5	µA
Protection grade	6000VDC isolated models, 240VAC/60Hz	2xMOPP		
Applied part	6000VDC isolated models	Type CF		

Output Specifications

Parameters	Conditions	Typical	Maximum	Units
Voltage accuracy	5% to 100% load	±1	±3	%
Balanced Load	Dual output models	±0.5	±1.5	%
Over voltage protection		≥ 110	160	% of Vout
Over current protection	3000VDC isolated 24Vout model	220	290	% of Iout
	6000VDC isolated models	150	260	% of Iout
	others	140	190	% of Iout
Short Circuit protection	Continuous			
Short circuit restart	Auto-recovery			
Line voltage regulation	LL to HL, output 1	±0.2	±0.5	%
	LL to HL, output 2	±0.5	±1	%
Load voltage regulation	5% to 100% load, output 1	±0.5	±1	%
	5% to 100% load, output 2	±0.5	±1.5	%
Cross voltage regulation	Output 1 50% load, output 2 10-100% load		±5	%
Ripple & Noise	1500VDC models		85	mV p-p
	3000VDC models	85	120	mV p-p
	6000VDC models	100	180	mV p-p
Transient Recovery Time	25% load step change	300	500	µS
Transient Response Deviation	25% load step change, 1.5KV 3.3/ 5/ ±5Vout	±5	±8	%
	25% load step change, others	±3	±5	%

General Specifications

Parameters	Conditions	Typical	Maximum	Units
Switching frequency		300		KHz
Operating temperature	Derating above +71	-40 to +85		°C
Storage temperature		-55 to +125		°C
Temperature coefficient		±0.03		%/°C
Max Case temperature			100	°C
Cooling	Free air convection			
Humidity			95	% RH
Soldering Temperature	1.5mm from lead for 10 sec.		300	°C
Case material	1500VDC Isolated models	Aluminum Alloy		
	3000 & 6000VDC Isolated models	Black flame-retardant plastic (UL94 V-0)		
Weight	1500VDC Isolated models	12		g
	3000 & 6000VDC Isolated models	13		g
Dimensions (L x W x H)	1500VDC Isolated models	1.26 x 0.79 x 0.42inches 32.00 x 20.00 x 10.80mm		
	3000 & 6000VDC Isolated models	1.24 x 0.80 x 0.40inches 31.60 x 20.30 x 10.20mm		
MTBF	>1 000 000hrs (MIL-HDBK -217F, Ground Benign, t=+25°C)			

NOTE: All specifications in this datasheet are measured at an ambient temperature of 25°C, humidity<75%, nominal input voltage and at rated output load unless otherwise specified.

Environment Specifications

Test	Parameters	Conditions
Vibration	1500VDC Isolated models	IEC/EN 61373 Category 1, class B
	3000 & 6000VDC Isolated models	10-55Hz, 2g, 30min, every axis tested

Safety Specifications

Parameters		
Approval	UL60950-1 for 1.5 and 3KV isolated models, UL62368-1(For models marked with # only)	
Standards	Design to meet EN50155 for 1.5KV isolated models Design to meet EN60601-1 3 rd edition, 2xMOPP, Type CF applied part for 6KV isolated models	
	EMI - Conducted and radiated emission	CISPER32/EN55032, class A, (without external component) class B, for 1.5 and 3KV isolated models (with the recommended EMC circuit part A) EN50121-3-2 for 1.5KV isolated models (with the recommended EMC circuit part A) EN55016-2-1 for 1.5KV isolated models (with the recommended EMC circuit part A)
	Electrostatic Discharge Immunity	IEC61000-4-2, contact ±4KV, Criteria B for 1.5 and 3KV isolated models IEC61000-4-2, contact ±6KV, Criteria B for 6KV isolated models EN50121-3-2, contact ±6KV, Air ±8KV, Criteria A for 1.5KV isolated models
	RF, Electromagnetic Field Immunity	IEC61000-4-3, 10V/m, Criteria A for 1.5 and 3KV isolated models EN50121-3-2, 20V/m, Criteria A for 1.5KV isolated models
	Electrical Fast Transient/Burst Immunity	IEC61000-4-4, ±2KV, Criteria B, (with the recommended EMC circuit part B) EN50121-3-2, ±2KV, Criteria A for 1.5KV isolated models (with the recommended EMC circuit part B)
	Surge Immunity	IEC61000-4-5, ±2KV, Criteria B, (with the recommended EMC circuit part B) EN50121-3-2, L-L ±1KV, Criteria A for 1.5KV isolated models (with the recommended EMC circuit part B)
	RF, Conducted Disturbance Immunity	IEC61000-4-6, 3Vrms, Criteria A EN50121-3-2, 10Vr.m.s, Criteria A for 1.5KV isolated models
	Voltage dips, short interruptions and voltage variations immunity	IEC61000-4-29, 0-70%, Criteria B

Dimensions

1500VDC Isolated models

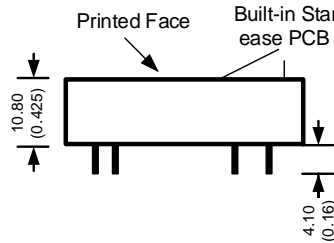
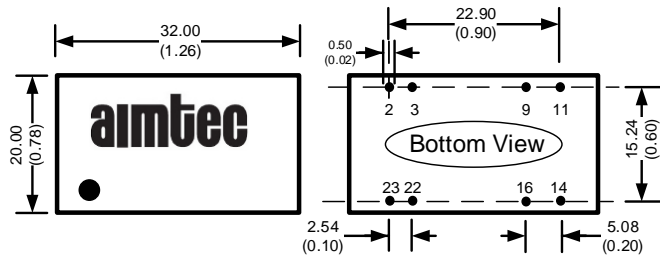

All dimensions are typical: millimeters (inches)
Pin Diameter: 0.50 ± 0.05 (0.02 ± 0.002)
Pin Pitch Tolerance: ± 0.35 (± 0.014)
Case Tolerance: ± 0.5 (± 0.02)

3000VDC Isolated models

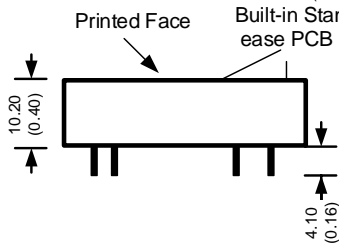
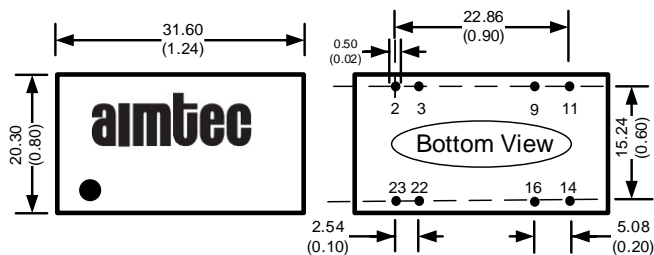

All dimensions are typical: millimeters (inches)
Pin Diameter: 0.50 ± 0.05 (0.02 ± 0.002)
Pin Pitch Tolerance: ± 0.35 (± 0.014)
Case Tolerance: ± 0.5 (± 0.02)

6000VDC Isolated models

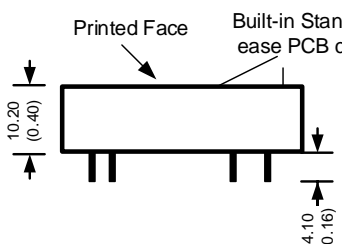
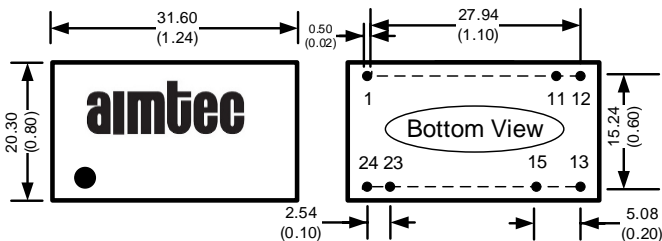

All dimensions are typical: millimeters (inches)
Pin Diameter: 0.50 ± 0.05 (0.02 ± 0.002)
Pin Pitch Tolerance: ± 0.35 (± 0.014)
Case Tolerance: ± 0.5 (± 0.02)

Pin	1500VDC & 3000VDC	
	Single	Dual
2	-V Input	-V Input
3	-V Input	-V Input
9	No pin	Common
11	N.C.	-V Output
14	+V Output	+V Output
16	-V Output	Common
22	+V Input	+V Input
23	+V Input	+V Input

Pin Out Specifications

Pin	6000VDC
	Single
1	+V Input
11	No Pin
12	-V Output
13	+V Output
15	No Pin
23/24	-V Input

Derating curve

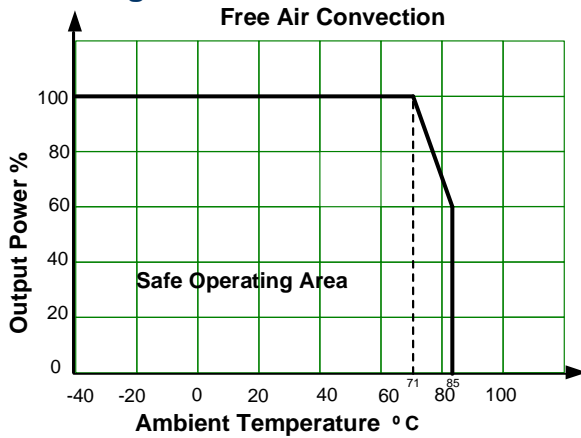

Typical application circuit

Single output models

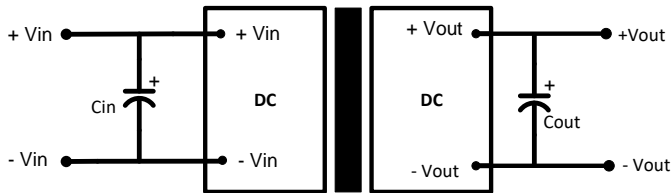

Vin	Cin	Cout
24V	100μF	10μF
48V	10-47μF	10μF

Dual output models

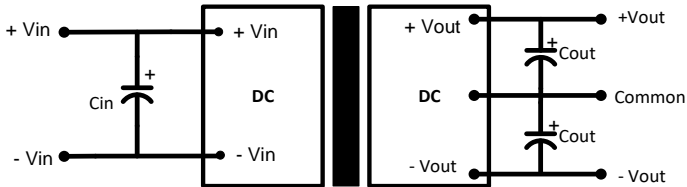

Recommended EMC circuit

1500VDC isolated models

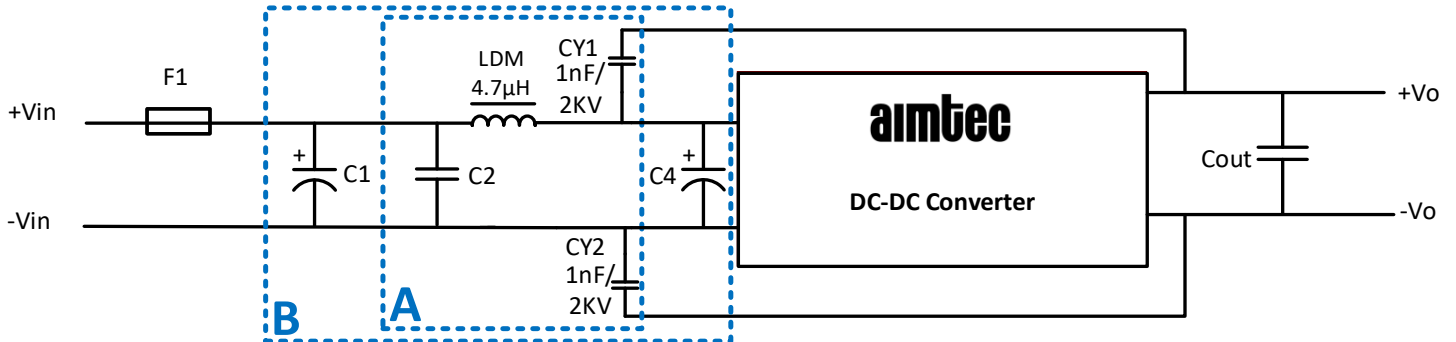

Vin	C1, C4	C2
24V	330μF/50V	1μF/50V
48V	330μF/100V	1μF/100V

3000VDC isolated models

Single and dual output models

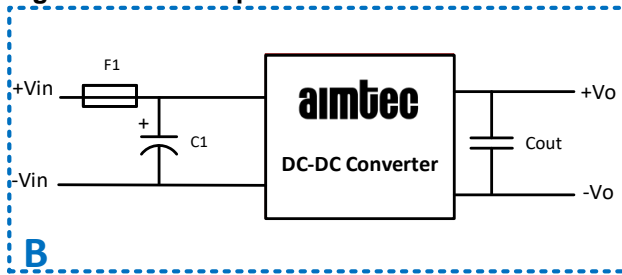

Vin	C1,	C2, C3
24V	1000µF/50V	2.2µF/50V
48V	680µF/100V	2.2µF/100V

Single output models

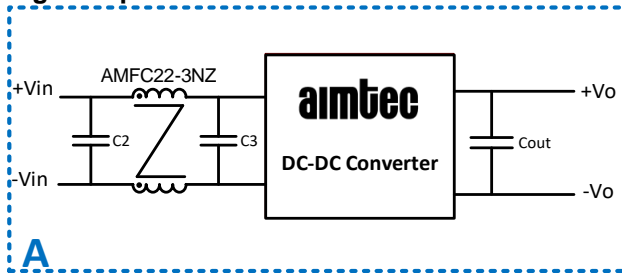

Dual output models

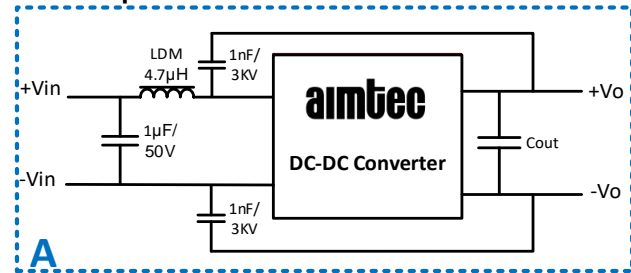

6000VDC isolated models

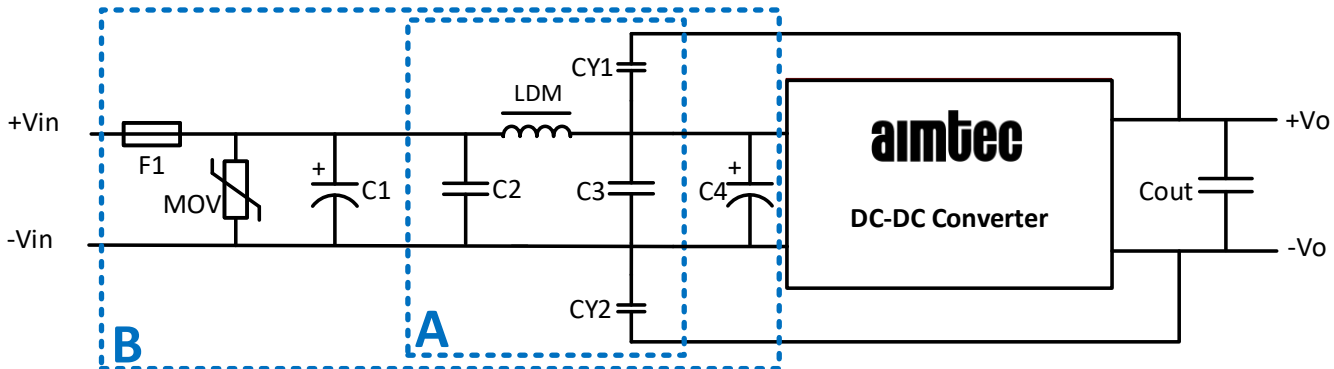

Vin	MOV	C1, C4	C2, C3	LDM	CY1, CY2
24V	S20K30	330µF/50V	10µF/50V	10µH	1nF/6KV
48V	S14K60	330µF/100V	-	-	-

Part B for EMS, part A for EMI

NOTE: 1. Datasheets are updated as needed and as such, specifications are subject to change without notice. Once printed or downloaded, datasheets are no longer controlled by Aimtec; refer to www.aimtec.com for the most current product specifications. 2. Product labels shown, including safety agency certifications on labels, may vary based on the date manufactured. 3. Mechanical drawings and specifications are for reference only. 4. All specifications are measured at an ambient temperature of 25°C, humidity<75%, nominal input voltage and at rated output load unless otherwise specified. 5. Aimtec may not have conducted destructive testing or chemical analysis on all internal components and chemicals at the time of publishing this document. CAS numbers and other limited information are considered proprietary and may not be available for release. 6. This product is not designed for use in critical life support systems, equipment used in hazardous environments, nuclear control systems or other such applications which necessitate specific safety and regulatory standards other than the ones listed in this datasheet. 7. Warranty is in accordance with Aimtec's standard Terms of Sale available at www.aimtec.com.