

PART NO.	A75590-001	REV	ECO	DATE	APP
		A	102844	08-29-16	HV

ACTUAL SIZE

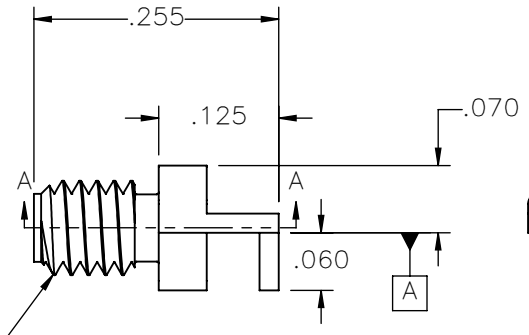

3-56 THREAD
DATUM A IS THE MOUNTING PLANE

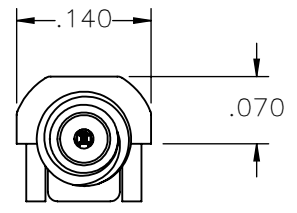
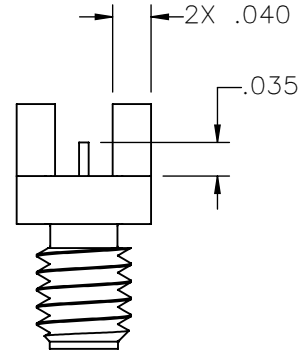
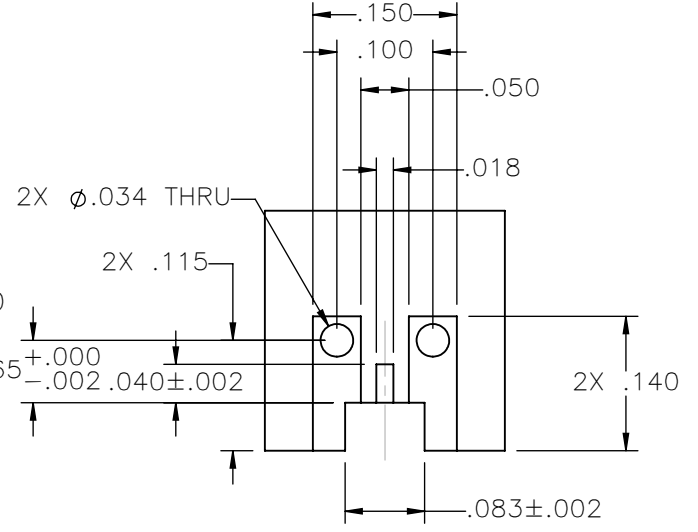
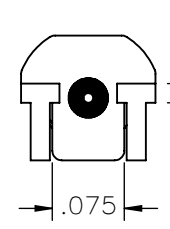

RECOMMENDED PCB LAYOUT

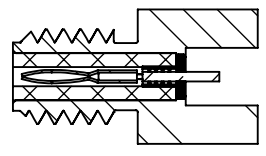
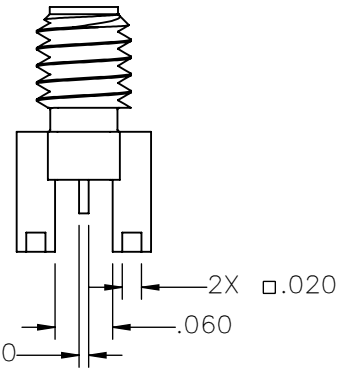

SECTION A-A

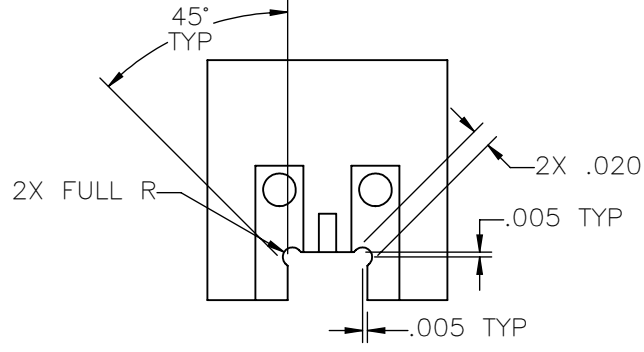

ALTERNATIVE CONTACT RELIEF CUTOUT

CXP	THIRD ANGLE
	-TOLERANCES-
SLDW	UNLESS OTHERWISE NOTED
	DIMENSIONS IN INCHES
	2 PL DEC ± .01
	3 PL DEC ± .005
	4 PL DEC ± .0005
	ANGLES ± 1°

THIS DRAWING CONTAINS CONFIDENTIAL AND PROPRIETARY INFORMATION WHICH IS THE PROPERTY OF OMNETICS CONNECTOR CORP. THIS DOCUMENT MAY NOT, IN WHOLE OR IN PART, BE DUPLICATED, OR DISCLOSED FOR ANY PURPOSE, WITHOUT WRITTEN PERMISSION FROM OMNETICS CONNECTOR CORP.	
DFTM. ACW	DATE 05-26-16
CHK'D.	DATE
APP'D.	DATE
TITLE: NANO COAX, 50 OHM, MALE BOARD EDGE MOUNT TWIST ON PLUG	

OMNETICS
CONNECTOR CORPORATION
7260 COMMERCE CIRCLE EAST
MINNEAPOLIS, MN 55432
WWW.OMNETICS.COM

CAGE CODE 61873
DWG NO. A75590-001
SHEET 1 OF 1
SCALE: 5:1
REV A