

Features

- 4:1 wide input voltage range
- 1.6kVDC isolation
- UL certified
- Efficiency up to 90%
- Six-sided continuous shield
- No minimum load required

Regulated Converter



RP20-AW

20 Watt

1" x 1"

Single and Dual Output



Description

The RP20-AW series are ultraminiature wide input voltage range power DC/DC converters in a case half the size of industry standard 20W converters. Despite their small size, the RP20-AW converters are fully specified devices with output currents up to 4.5 Amps, up to 90% efficiency, no minimum load, 1600VDC isolation, a built-in Class A EMC filter and low ripple/noise figures. The outputs are also fully protected against short circuits, overcurrent and overvoltage. The no load input current is particularly low (only 4mA/6mA). The RP20-AW series will find many uses in applications where board space and/or board height is at a premium or in battery-powered systems where standby current is important.

Selection Guide

Part Number	Input Voltage Range [VDC]	Output Voltage [VDC]	Output Current [mA]	Input ⁽¹⁾ Current [mA]	Efficiency ⁽¹⁾ typ. [%]	Max. Capacitive Load ⁽²⁾ [µF]
RP20-243.3SAW ^(3,4)	9-36	3.3	4500	695	89	7000
RP20-2405SAW ^(3,4)	9-36	5	4000	936	89	5000
RP20-2412SAW ^(3,4)	9-36	12	1670	938	89	850
RP20-2415SAW ^(3,4)	9-36	15	1330	934	89	700
RP20-483.3SAW ^(3,4)	18-75	3.3	4500	356	87	7000
RP20-4805SAW ^(3,4)	18-75	5	4000	468	89	5000
RP20-4812SAW ^(3,4)	18-75	12	1670	469	89	850
RP20-4815SAW ^(3,4)	18-75	15	1330	462	90	700
RP20-2412DAW ^(3,4)	9-36	±12	±833	936	89	±500
RP20-2415DAW ^(3,4)	9-36	±15	±667	926	90	±350
RP20-4812DAW ^(3,4)	18-75	±12	±833	468	89	±500
RP20-4815DAW ^(3,4)	18-75	±15	±667	463	90	±350

Notes:

- Note1: Maximum values at nominal input voltage and full load
 Note2: Max. Cap load is tested at minimum Input and constant resistive load



UL60950-1 certified

Model Numbering

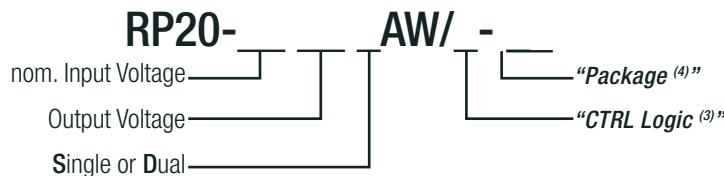

Notes:

- Note3: standard part is without suffix "P" or "N" = without CTRL & Trim function
 Trim function is only available for single output with /P or /N suffix
 add suffix "P" for CTRL function with positive logic (1=ON, 0=OFF), including trim pin
 add suffix "N" for CTRL function with negative logic (0=ON, 1=OFF), including trim pin
 Note4: add suffix "-HC" for premounted Heat-sink with clamps

Ordering Examples

- RP20-2405SAW/P = 24V input, 5V output, single, positive Logic CTRL pin
 RP20-4812DAW-HC = 48V input, ±12V output, dual, without CTRL pin, Heat-sink premounted

Specifications (measured @ Ta= 25°C, nom. Vin, full load unless otherwise stated)

BASIC CHARACTERISTICS					
Parameter	Condition		Min.	Typ.	Max.
Internal Input Filter					Pi-Type
Input Voltage Range	nom. Vin = 24VDC nom. Vin = 48VDC		9VDC 18VDC	24VDC 48VDC	36VDC 75VDC
Input Surge Voltage	1s max.	nom. Vin = 24VDC nom. Vin = 48VDC			50VDC 100VDC
Under Voltage Lockout (UVLO)	nom. Vin = 24VDC	DC-DC ON DC-DC OFF		8VDC	9VDC
	nom. Vin = 48VDC	DC-DC ON DC-DC OFF		16VDC	18VDC
Output Voltage Trimming	refer to "OUTPUT VOLTAGE TRIMMING"		-10%		+10%
Minimum Load			0%		
Start-up Time	Power up ON/OFF CTRL				30ms 30ms
ON/OFF CTRL ⁽⁵⁾ refer to "ON/OFF CTRL"	Positive Logic	DC-DC ON DC-DC OFF	Open or 3.0VDC < V _{CTRL} < 15VDC Short or 0VDC < V _{CTRL} < 1.2VDC		
	Negative Logic	DC-DC ON DC-DC OFF	Short or 0VDC < V _{CTRL} < 1.2VDC Open or 3.0VDC < V _{CTRL} < 15VDC		
Input Current of CTRL pin	drive current	I _{CTRL}	-0.5mA		+1.0mA
Standby Current	DC-DC OFF	I _{in}		2mA	
Internal Operating Frequency	3.3Vout, 5Vout		248kHz	275kHz	303kHz
	Others		297kHz	330kHz	363kHz
Output Ripple and Noise	measured at 20MHz BW with a 1µF M/C X7R and 10µF T/C		Single	75mVp-p	
			Dual	100mVp-p	
Input Reflected Ripple Current ⁽⁶⁾				30mA _{p-p}	

Notes:

Note5: If no suffix is specified, the control pin will be omitted. If fitted, the ON/OFF control function can be positive or negative logic. The pin voltage is referenced to -Vin pin

Note6: Simulated source impedance of 12µH. 12µH inductor in series with +Vin

RP20-2405SAW

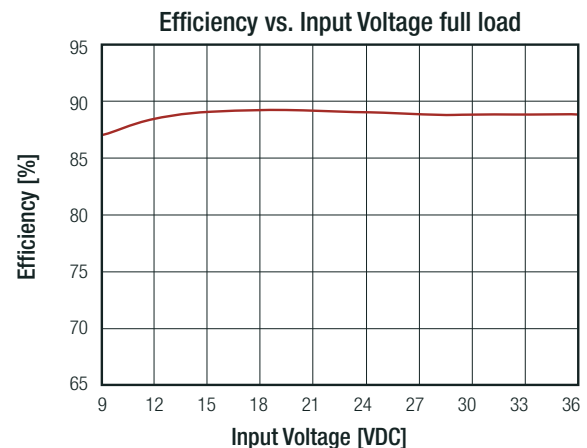
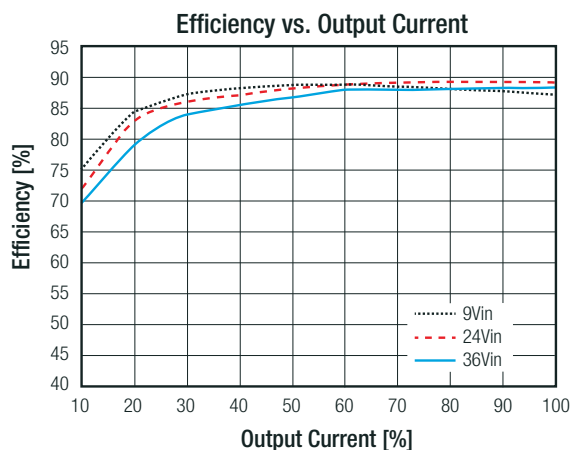

continued on next page

Specifications (measured @ Ta= 25°C, nom. Vin, full load unless otherwise stated)

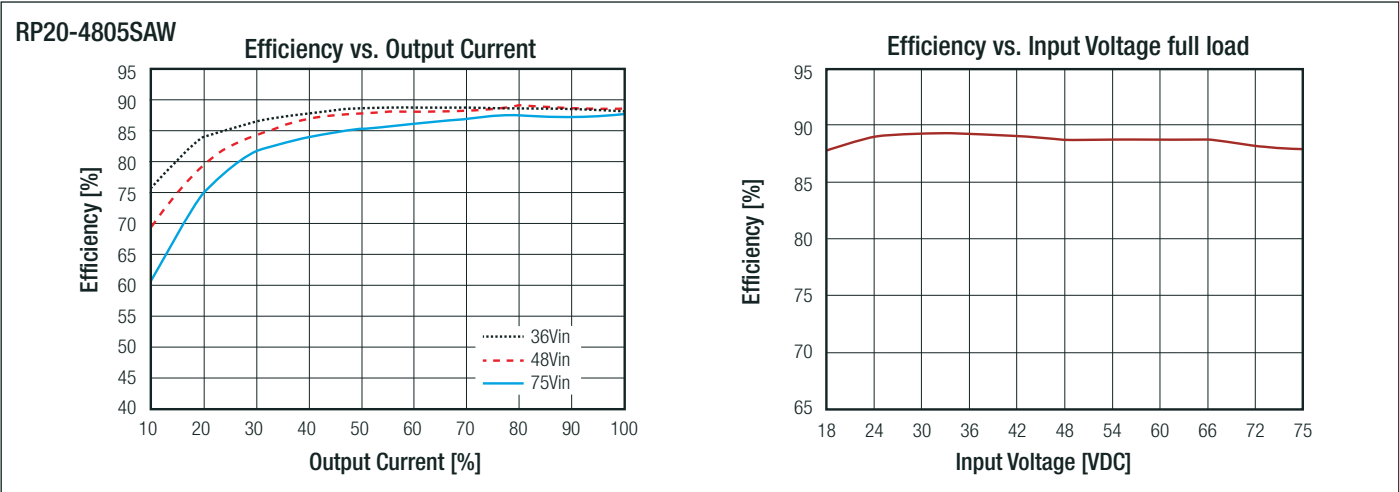

OUTPUT VOLTAGE TRIMMING

Output Voltage Trimming

Single output Powerline converters offer the feature of trimming the output voltage over a certain range around the nominal value by using external trim resistors. No general equation can be given for calculating the trim resistors, but the following trimtables give typical values for choosing these trimming resistors. If voltages between the given trim points are required, extrapolate between the two nearest given values to work out the resistor required or use a variable resistor to set the output voltage. Output can be externally trimmed by using the method shown below.

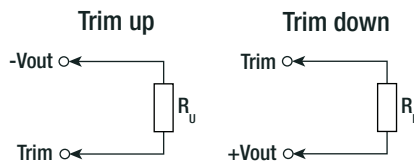

RP20-xx3.3SAW

Trim up	1	2	3	4	5	6	7	8	9	10	[%]
Vout =	3.333	3.366	3.399	3.432	3.465	3.498	3.531	3.564	3.597	3.63	[VDC]
R _u =	385.071	191.511	126.990	94.730	75.374	62.470	53.253	46.340	40.963	36.662	[kΩ]
Trim down	1	2	3	4	5	6	7	8	9	10	[%]
Vout =	3.267	3.234	3.201	3.168	3.135	3.102	3.069	3.036	3.003	2.97	[VDC]
R _d =	116.719	54.779	34.133	23.810	17.616	13.486	10.537	8.325	6.604	5.228	[kΩ]

RP20-xx05SAW

Trim up	1	2	3	4	5	6	7	8	9	10	[%]
Vout =	5.05	5.10	5.15	5.20	5.25	5.30	5.35	5.4	5.45	5.50	[VDC]
R _u =	253.450	125.700	83.117	61.825	49.050	40.533	34.450	29.888	26.339	23.500	[kΩ]
Trim down	1	2	3	4	5	6	7	8	9	10	[%]
Vout =	4.95	4.90	4.85	4.80	4.75	4.70	4.65	4.60	4.55	4.50	[VDC]
R _d =	248.340	120.590	78.007	56.715	43.940	35.423	29.340	24.778	21.229	18.390	[kΩ]

RP20-xx12SAW

Trim up	1	2	3	4	5	6	7	8	9	10	[%]
Vout =	12.12	12.24	12.36	12.48	12.60	12.72	12.84	12.96	13.08	13.20	[VDC]
R _u =	203.223	99.057	64.334	46.973	36.557	29.612	24.652	20.932	18.038	15.723	[kΩ]
Trim down	1	2	3	4	5	6	7	8	9	10	[%]
Vout =	11.88	11.76	11.64	11.52	11.40	11.28	11.16	11.04	10.92	10.8	[VDC]
R _d =	776.557	380.723	248.779	182.807	143.223	116.834	97.985	83.848	72.853	64.057	[kΩ]

continued on next page

Specifications (measured @ Ta= 25°C, nom. Vin, full load unless otherwise stated)

RP20-xx15SAW											
Trim up	1	2	3	4	5	6	7	8	9	10	[%]
Vout =	15.15	15.3	15.45	15.60	15.75	15.90	16.05	16.20	16.35	16.50	[VDC]
R _u =	161.557	78.223	50.446	36.557	28.223	22.668	18.700	15.723	13.409	11.557	[kΩ]
Trim down	1	2	3	4	5	6	7	8	9	10	[%]
Vout =	14.85	14.70	14.55	14.40	14.25	14.10	13.95	13.80	13.65	13.50	[VDC]
R _d =	818.223	401.557	262.668	193.223	151.557	123.779	103.938	89.057	77.483	68.223	[kΩ]

ON/OFF CTRL

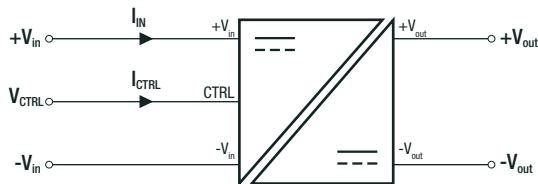

Positive Logic	DC-DC ON	Open or 3.0VDC < V _{CTRL} < 15VDC
	DC-DC OFF	Short or 0VDC < V _{CTRL} < 1.2VDC
Negative Logic	DC-DC ON	Short or 0VDC < V _{CTRL} < 1.2VDC
	DC-DC OFF	Open or 3.0VDC < V _{CTRL} < 15VDC

REGULATIONS

Parameter	Condition		Value
Output Accuracy			±1.0%
Line Regulation	low line to high line, full load	Single	±0.2%
		Dual	±0.5%
Load Regulation	0% to 100% load	Single	±0.2%
		Dual	±1.0%
		10% to 90% load	Single
		Dual	±0.8%
Cross Regulation	asymmetrical 25%<>100% load		±5.0%
Transient Response Recovery Time	25% load step change		250µs typ.

PROTECTIONS

Parameter	Condition		Value
Short Circuit Protection (SCP)			continuous, automatic recovery
Over Voltage Protection (OVP)	zener diode clamp	3.3Vout	3.7 - 5.4VDC
		5Vout	5.6 - 7.0VDC
		12Vout	13.5 - 19.6VDC
		15Vout	16.8 - 20.5VDC
Over Load Protection (OLP)	% of lout rated		150% typ., Hiccup mode
Isolation Voltage ⁽⁸⁾	I/P to O/P		1.6kVDC/ 1 minute
	I/P to O/P to case		1.0kVDC/ 1 minute
Isolation Resistance	Viso= 500VDC		1GΩ min
Isolation Capacitance			1500pF max.

Notes:

Note7: For repeat Hi-Pot testing, reduce the time and/or the test voltage

Note8: This power module is not internally fused. An input line fuse must always be used

Recom suggests: 24Vin= T4A; 48Vin= T2A slow blow types

Specifications (measured @ Ta= 25°C, nom. Vin, full load unless otherwise stated)

ENVIRONMENTAL			
Parameter	Condition	Value	
Operating Temperature Range	without derating	-40°C to +68°C	
	with derating	-40°C to +101°C	
Maximum Case Temperature		+105°C	
Temperature Coefficient		±0.02%/K max.	
Thermal Impedance	@ natural convection 0.1m/s		
	without heat-sink	17.6K/W	
	with heat-sink	14.8K/W	
Operating Humidity	non-condensing	5% - 95% RH	
Thermal Shock		according to MIL-STD-810F	
Vibration		according to MIL-STD-810F	
MTBF	+25°C	according to MIL-HDBK-217F, G.B.	1469 x 10 ³ hours
		Bellcore TR-NWT-000332 ⁽⁹⁾	1766 x 10 ³ hours

Derating Graph ⁽¹⁰⁾

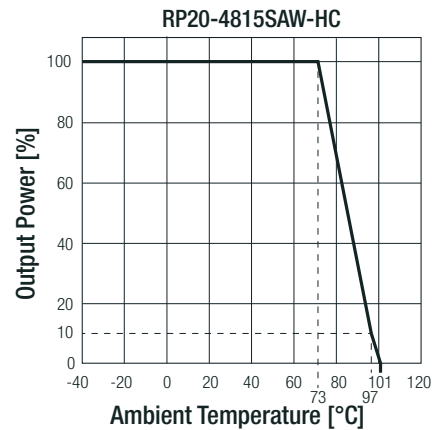
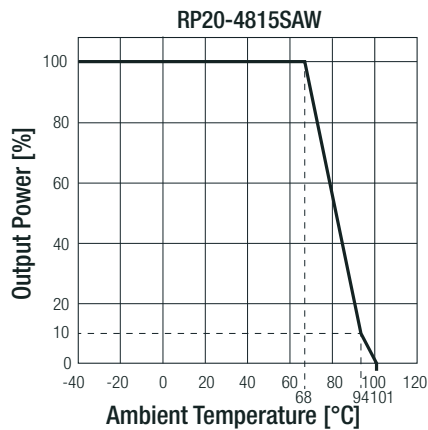

Notes:

Note9: BELLCORE TR-NWT-000332. Case I: 50% Stress, Ta= 40°C. MIL-HDBK 217F Notice 2. Ta = 25°C, full load, (controlled environment)

Note10: Derating graphs are valid only for the shown part numbers. If you need detailed derating-information about a part-number not shown here please contact RECOM Techsupport for detailed information

SAFETY AND CERTIFICATIONS

Certificate Type (Safety)	Condition	Standard
Information Technology Equipment, General Requirements for Safety	E196683	UL60950-1, 1st Edition, 2007 CAN/CSA-C22.2 No. 60950-1-03, 1st Edition, 2006
EAC	RU-AT.49.09571	TP TC 004/2011
RoHS 2		RoHS-2011/65/EU + AM-2015/863

EMC Compliance	Condition	Standard / Criterion
Electromagnetic compatibility of multimedia equipment - Emission requirements	without external filter	EN55032, Class A
	with external filter	EN55032, Class B
ESD Electrostatic discharge immunity test	Air ±8kV and Contact ±6kV	EN61000-4-2, Criteria A
Radiated, radio-frequency, electromagnetic field immunity test	10 V/m	EN61000-4-3, Criteria A
Fast Transient and Burst Immunity ⁽¹¹⁾	±2kV	EN61000-4-4, Criteria A
Surge Immunity ⁽¹¹⁾	±2kV	EN61000-4-5, Criteria A
Immunity to conducted disturbances, induced by radio-frequency fields	10 Vr.m.s	EN61000-4-6, Criteria A
Power Magnetic Field Immunity	100A/m continuous; 1000A/m 1s	EN61000-4-8, Criteria A

Notes:

Note11: An external input filter capacitor is required if the module has to meet EN61000-4-4, EN61000-4-5
Recom suggests Nippon chemi-con KY series 220µF/100V

continued on next page

Specifications (measured @ Ta= 25°C, nom. Vin, full load unless otherwise stated)

EMC Filtering Suggestions according to EN55032

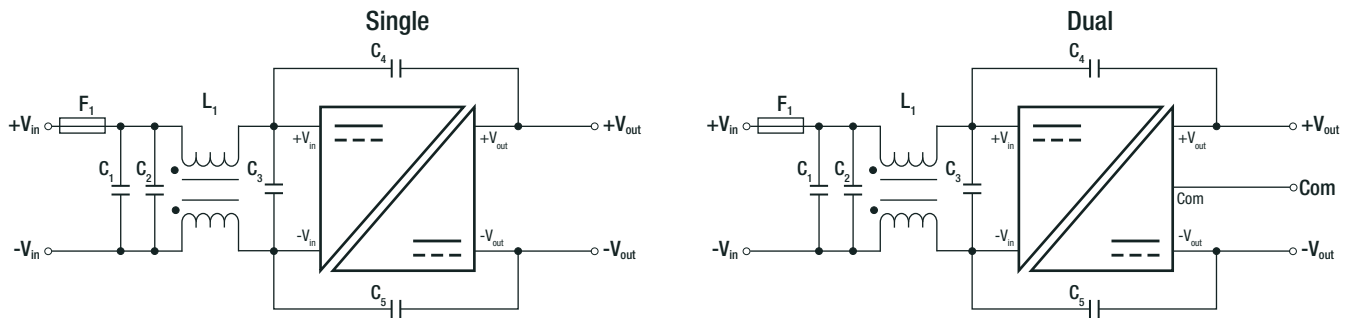

Component List Class B

MODEL	C1	C2	C3	C4/C5	L1
RP20-24xxSAW, RP20-24xxDAW	4.7µF/25V 1812 MLCC	N/A	N/A	470pF/2kV 1808 MLCC	CMC: 325µH ref.: WE 744290321 ref.: CMC-06
RP20-48xxSAW, RP20-48xxDAW	2.2µF/100V 1812 MLCC	2.2µF/100V 1812 MLCC	2.2µF/100V 1812 MLCC	470pF/2kV 1808 MLCC	CMC: 325µH ref.: WE 744290321 ref.: CMC-06

DIMENSIONS AND PHYSICAL CHARACTERISTICS

Parameter	Type	Value
Material	case	nickel coated copper
	base	FR4 PCB
	potting	silicone (UL94-V0)
Dimensions (LxWxH)	without Heat-sink	25.4 x 25.4 x 9.9mm
	with Heat-sink	31.4 x 25.4 x 16.5mm
Weight	without Heat-sink	15g
	with Heat-sink	21.44g

Dimension Drawing (mm)

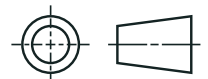
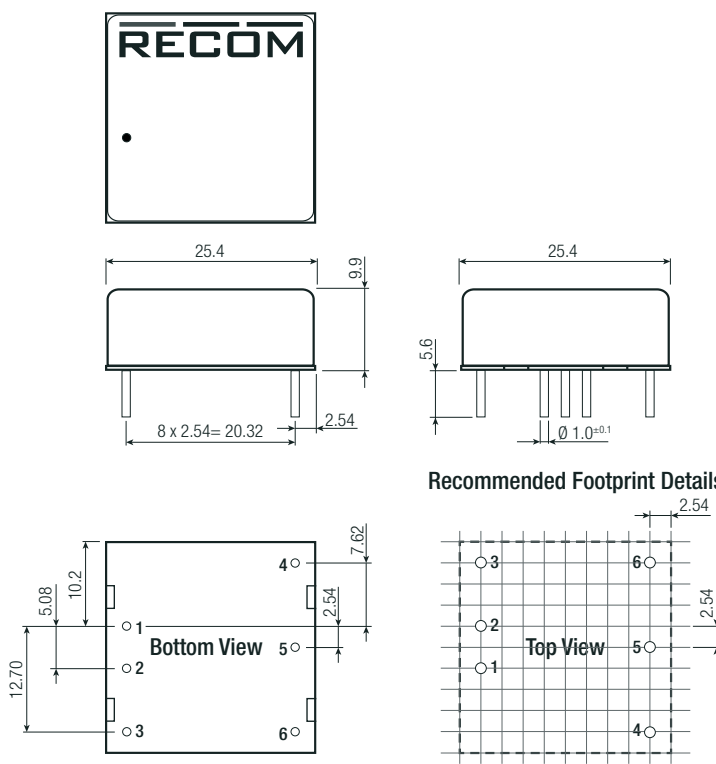

Pinning Information

Pin #	Single	Dual
1	+Vin	+Vin
2	-Vin	-Vin
3	CTRL ⁽³⁾	CTRL ⁽³⁾
4	+Vout	+Vout
5	Trim	Com
6	-Vout	-Vout

Pin Pitch Tolerance ±0.25mm
Tolerance: xx.x= ±0.5mm
xx.xx= ±0.25mm

continued on next page

Specifications (measured @ Ta= 25°C, nom. Vin, full load unless otherwise stated)

Dimension Drawing with Heat-sink (mm)

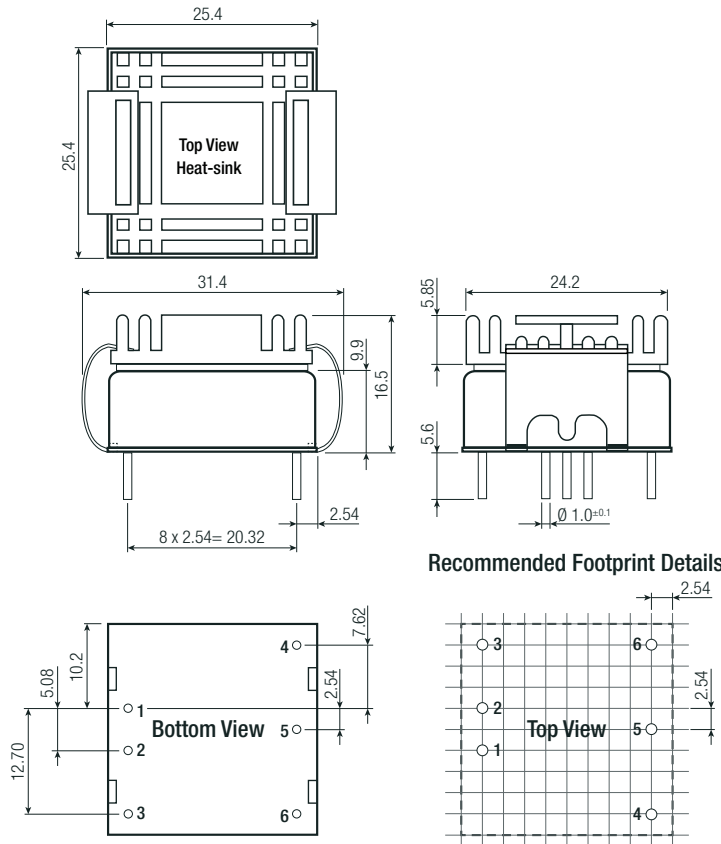
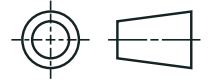

Pinning Information

Pin #	Single	Dual
1	+Vin	+Vin
2	-Vin	-Vin
3	CTRL ⁽³⁾	CTRL ⁽³⁾
4	+Vout	+Vout
5	Trim	Com
6	-Vout	-Vout

Pin Pitch Tolerance ±0.25mm
Tolerance: xx.x= ±0.5mm
xx.xx= ±0.25mm

Recommended Footprint Details

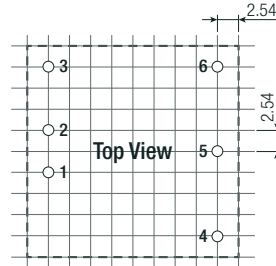

PACKAGING INFORMATION

Parameter	Type		Value
Packaging Dimension (LxWxH)	tube	without heat-sink	257.0 x 28.5 x 21.0mm
	tray	with heat-sink	230.0 x 180.0 x 28.0mm
Packaging Quantity	tube	without heat-sink	8pcs
	tray	with heat-sink	20pcs
Storage Temperature Range			-55°C to +125°C
Storage Humidity	non-condensing		5% - 95% RH

The product information and specifications may be subject to changes even without prior written notice. The product has been designed for various applications; its suitability lies in the responsibility of each customer. The products are not authorized for use in safety-critical applications without RECOM's explicit written consent. A safety-critical application is an application where a failure may reasonably be expected to endanger or cause loss of life, inflict bodily harm or damage property. The applicant shall indemnify and hold harmless RECOM, its affiliated companies and its representatives against any damage claims in connection with the unauthorized use of RECOM products in such safety-critical applications.