



FEATURES

- Popular Power PCB Relay Footprint - T90
- 40 Amp 240 VAC General Purpose UL Rating
- 2 HP 250 VAC Rating
- UL Class F Insulation Standard
- 4 kV Dielectric Option (-H) Available
- Meets UL 508 and UL 873 Spacing with Pin 6 Omitted*
- RoHS Compliant

UL / CUL Ratings

cUL US E93379

Load Type	Voltage	Cycles	1 Form A (SPST-NO)	1 Form B (SPDT-NC)	1 Form C (SPDT)	
					NO	NC
General Purpose	240 VAC	6,000	30 A	20 A	30 A	20 A
	277 VAC	6,000	30 A	20 A	30 A	20 A
	280 VAC	6,000	5 A	5 A	5 A	5 A
Resistive	240 VAC	250,000	40 A	30 A	40 A	30 A
	240 VAC		20 A	—	20 A	—
	277 VAC	100,000	25 A	—	25 A	—
	30 VDC	—	40 A	30 A	40 A	30 A
Motor	250 VAC	30,000	2 HP	1.5 HP	2 HP	1.5 HP
	120 VAC	30,000	1 HP	—	1 HP	—
Ballast	280 VAC	6,000	5 A	5 A	5 A	5 A

CONTACT DATA

Material	AgCdO, AgSnO ₂ In ₂ O ₃ , AgCdO+AU	
Initial Contact Resistance	50 mΩ Max. @ 1 A, 6 VDC	
Maximum Switching Voltage	110 VDC, 300 VAC	
Maximum Switching Current	40 A	
Maximum Switching Power	1,200 W, 10,000 VA	
Service Life	Mechanical	1 x 10 ⁷ Operations
	Electrical	5 x 10 ⁴ Operations

*6 pin version meets UL 508
 5 pin (-1) version meets UL 508 and UL 873 spacing - 3.18 mm through air, 6.36 mm over surface.

CHARACTERISTICS

Dielectric Strength	1,500 V, 50 Hz Between Open Contacts
	2,500 V, 50 Hz Between Contacts and Coil
H Version	4,000 V, 50 Hz Between Contacts and Coil
Shock Resistance	200 m/s ² 11 ms
Vibration Resistance	10 Hz - 55 Hz Double Amplitude 1.5 mm
Terminal Strength	10N
Solderability	260°C for 5 seconds
Storage Temp. Range	-55°C to 125°C
Operating Temp. Range	-55°C to 100°C
Relative Humidity	85% (at 40°C)
Weight	30 grams, 27 grams Open
Material Compliant To	EU RoHS V2, EU REACH V3
Insulation Resistance	1,000 MΩ min, at 500 V

Additional UL / CUL Ratings for AgSnO Contacts

Load Type	Voltage	Cycles	Temp.	1 Form A (SPST-NO)	1 Form C (SPDT-NO)
Resistive	277/250 VAC	30,000	40°C	30 A	30 A

ORDERING INFORMATION

Model:	Example: PTRD	-1C	-12	S			-1	-X		G
Contact Form:	1A, 1B, 1C									
Coil Voltage:	3, 5, 6, 9, 12, 15, 18, 24, 48, 110									
Enclosure:	Nil: Open Frame; S: Sealed									
Insulation Material:	Nil: Class F									
Contact Material:	Nil: AgCdO; T: AgSnO ₂ In ₂ O ₃									
Spacing:	Nil: UL508; -1: UL 508 and UL 873 (Pin #6 Omitted)									
RoHS/Dielectric:	X: RoHS Compliant; XH: RoHS plus 4 kV Dielectric (H Version has Pin #6 Omitted)									
Coil Sensitivity:	Nil: 0.9 W ⁽¹⁾ ; 0.6: 0.6 W; 1.1: 1.1 W									
Gold Plated Contacts:	Nil: None; G: AgCdO+Au									

Box Quantity: 600; Inner Box 300

(1) 0.9 W is Industry Standard

COIL DATA

Coil Voltage (VDC) (2)		Coil Power (W) Resistance (Ohms ± 10%)			Coil Power (W) Must Operate Voltage Max (VDC)		Must Release Voltage Min (VDC) (3)
Rated	Max	0.6 W	0.9 W (1)	1.1 W	0.6 W & 0.9 W (2)	1.1 W	
3	3.9	15	10	—	2.25	—	0.3
5	6.5	42	28	—	3.75	—	0.5
6	7.8	60	40	33	4.50	4.8	0.6
9	11.7	135	90	—	6.75	—	0.9
12	15.6	240	150	131	9.00	9.6	1.2
15	19.5	375	260	—	10.25	—	1.5
18	23.4	540	380	—	13.50	—	1.8
24	31.2	960	640	524	18.00	19.2	2.4
48	62.4	3840	2560	2095	36.00	38.4	4.8
110	143	20167	13445	—	82.50	—	11.0

NOTES:

(1) 0.9 W is Industry Standard

(2) The use of any coil voltage less than the rated voltage will compromise the operation of the relays.

(3) Must Operate Voltage and Must Release Voltages are for test purposes only and are not to be used as design criteria.

COIL DATA Continued

Operate Time	Less than 15 ms.
Release Time	Less than 10 ms
Power Consumption	0.6 W, 0.9 W, 1.1 W

DIMENSIONS (mm/inches)

Knock off, on top corner, nib for ventilation after soldering and water wash.

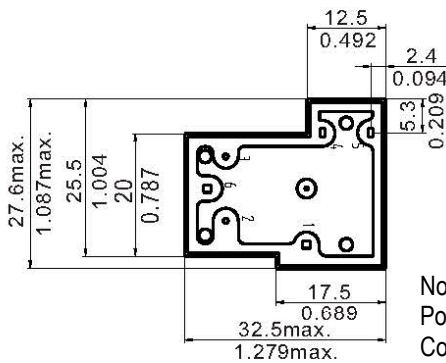

Note:
Power Pins are 0.8 mm x 1.5 mm
Coil Pins are Ø0.8 mm

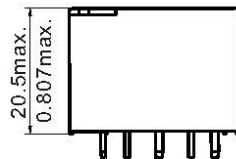
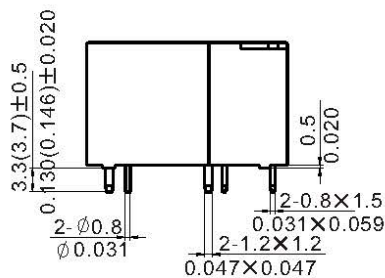
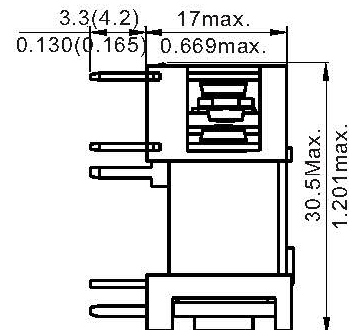
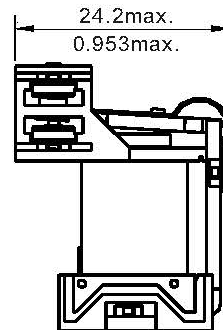

Open type

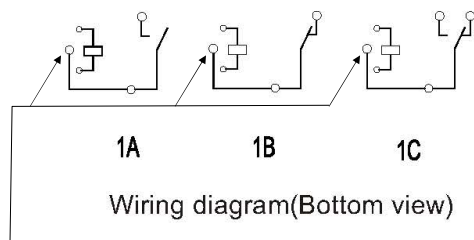

Wiring diagram(Bottom view)

-1 with Pin 6 Omitted

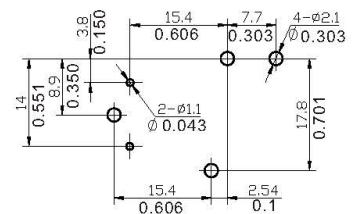
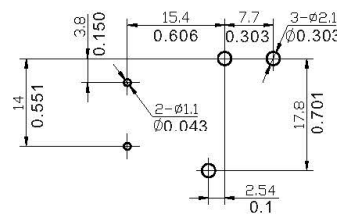

Mounting (Bottom view)

Pin 6 omitted when using 4 kV dielectric option (-H) and/or (-1) Option



T90 Style Relays

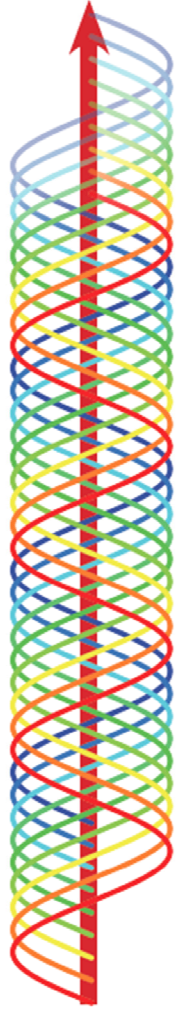
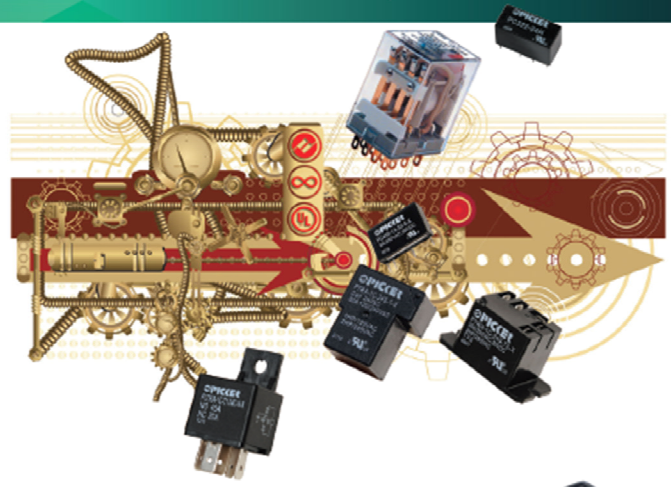

50 Amp **PTRV 50/35 Amp 1,500 W, 12,000 VA**

- Larger Contacts than PTRD
- *Braided Copper Wire Added to Dissipate Heat from Contacts to the Coil Frame and PCB Pins*
- 50 Amp 240 VAC 10,000 Cycle UL Resistive Rating
- Class F Material -40° to 125° C Standard

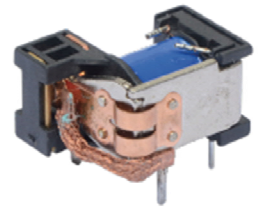

45 Amp **PTRD 45 Amp 277 VAC 12,500 VA**

New

- >1.8 mm Contact Gap
- 2.25 Watt Coil for Vibration Tolerance
- Class F Material -40° to 85° C Standard
- Designed for PV Inverter & Motor Control Applications



40 Amp **PTRD 40/30 Amp 1,200 W, 10,000 VA**
PTRA AC Coil Options from 12 to 277 VAC

- Larger Contacts than PTRH
- 40 Amp 240 VAC UL Resistive Rating
- 25 Amp 277 VAC 100K Cycles UL Resistive Rating
- Class F Material -40° to 125° C Standard



30 Amp **PTRH 30/20 Amp 900 W, 7,500 VA**

- 30 Amp 277 VAC UL General Purpose Rating
- 30 Amp 250 VAC 100K Cycle UL Resistive Rating
- Class B -40° to 100° C Standard, Optional Class F

Packaging Options (i.e. PTRH-T)



Dust Cover or Sealed with Scratch off Nib



-T (T2 & T3) with PC Pins and Contact QC



-T (T4 & T5) w/QC Tabs & Mounting Ears



-OT (OT2 & OT3) with PC Pins and Contact QC



-OT (OT4 & OT5) w/QC Tabs & Mounting Ears

888-997-3933 • PickerComponents.com
Sales@PickerComponents.com

