

Voltage selector switch, 6 stages, serie-parallel, PCB mounting



See below:

Approvals and Compliances

Description

- Voltage Selector , 6 stages
- Series-parallel connections
- PCB terminals

References

Alternative: version for panel mounting [SWZ1 \(Frontpl\)](#)

Weblinks

[pdf data sheet](#), [html datasheet](#), [General Product Information](#), [Approvals](#), [Distributor-Stock-Check](#), [Detailed request for product](#)

Technical Data

Ratings	IEC: 6.3 A / 250 VAC; 50 Hz
	UL: 10 A / 250 VAC; 60 Hz
	CSA: 6.3 A / 250 VAC; 60 Hz
Mounting	PCB
Terminal	Solder / THT
Number of Stages	6
Lifetime	300 operating cycles (without load)
Degree of Protection	front side IP40
Protection Class	Suitable for appliances with protection class II acc. to IEC 61140
Allowable Operation Temperature	-40 °C to 85 °C
Climatic Category	25/85/21 acc. to IEC 60068-1
Material: Socket	Thermoplastic, black, UL 94V-0
Weight	11.8 g

Solderability	235 °C / 2 sec acc. to IEC 60068-2-20, Test Ta, method 1
Resistance to Soldering Heat	260 °C / 5 sec acc. to IEC 60068-2-20, Test Tb, method 1A
Insulation Resistance	> 10'000MΩ (500VDC; 1min)
Contact Resistance	< 10 mΩ at 20 mV
Dielectric Strength	> 2kVAC between L-N > 4kVAC between L/N-PE (1min; 50Hz)
Clearance and Creepage Distance	> 3mm > 8mm between L/N-PE
Resistance to Vibration	acc. to IEC 60068-2-6, test Fc

Approvals and Compliances



Detailed information on product approvals, code requirements, usage instructions and detailed test conditions can be looked up in [Details about Approvals](#)

SCHURTER products are designed for use in industrial environments. They have approvals from independent testing bodies according to national and international standards. Products with specific characteristics and requirements such as required in the automotive sector according to IATF 16949, medical technology according to ISO 13485 or in the aerospace industry can be offered exclusively with customer-specific, individual agreements by SCHURTER.

Approvals



The approval mark is used by the testing authorities to certify compliance with the safety requirements placed on electronic products.

Approval Reference Type: SWZ

Approval Logo	Certificates	Certification Body	Description
	VDE Approvals	VDE	Certificate Number:
	UL Approvals	UL	UR File Number: E72661
	CSA Approvals	CSA	CSA Certification Record: LR45945

Product standards

Product standards that are referenced

Organization	Design	Standard	Description
	Designed according to	UL 508	Industrial control equipment
	Designed according to	CSA C22.2 no. 55	Industrial Control Equipment



Application standards

Application standards where the product can be used

Organization	Design	Standard	Description
	Suitable for applications acc.	IEC/UL 62368-1	Audio/video, information and communication technology equipment - Part 1: Safety requirements

Compliances

The product complies with following Guide Lines

Identification	Details	Initiator	Description
	CE declaration of conformity	SCHURTER AG	The CE marking declares that the product complies with the applicable requirements laid down in the harmonisation of Community legislation on its affixing in accordance with EU Regulation 765/2008.
	UKCA declaration of conformity	SCHURTER AG	The UKCA marking declares that the product complies with the applicable requirements laid down in the British Amendment of Regulation (EC) 765/2008.
	REACH	SCHURTER AG	On 1 June 2007, Regulation (EC) No 1907/2006 on the Registration, Evaluation, Authorization and Restriction of Chemicals 1 (abbreviated as "REACH") entered into force.

Dimension [mm]

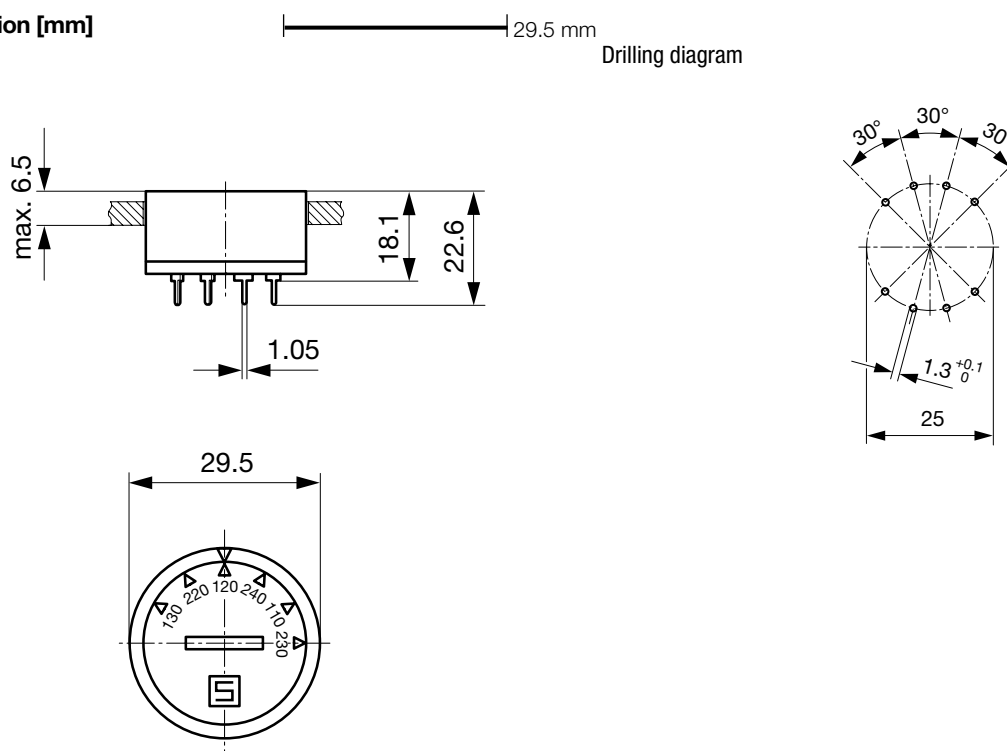

Diagrams

Reverse view

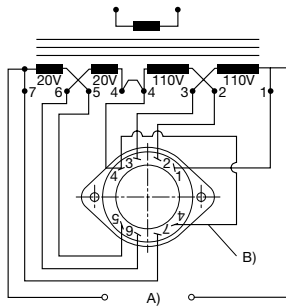

A) Power mains
 B) External connection

All Variants

Stage 1	Stage 2	Letterings				Stage 6	Order Number
		Stage 3	Stage 4	Stage 5	Stage 6		
150	220	130	260	110	240	0033.3801	
130	220	120	240	110	230	0033.3802	
140	200	120	240	100	220	0033.3805	
100	240	-	220	120	-	0033.3812	
						0033.3814	
	220			110	240	0033.3819	
145	210	125	250	105	230	0033.3833	
120	220	115	230	110	225	0033.3846	

Availability for all products can be searched real-time: <https://www.schurter.com/en/Stock-Check/Stock-Check-SCHURTER>

Packaging Unit

50 Pcs