





KK 254 / .100

**WIRE-TO-BOARD
BOARD-TO-BOARD
CONNECTOR SYSTEM**

Crimp Terminal	Crimp Terminal
	
Series: 2759 , 6459	Series: 41572



Crimp Terminal	Crimp Terminal
	
Series: 4089	Series: 8088







[KK 254 WEB PAGE](#)

[TABLE OF CONTENTS](#)

REVISION: T3	ECM INFORMATION: EC No: 617830617830 DATE: 2019/05/24201 05/24	TITLE: PRODUCT SPECIFICATION .100 CENTER KK CONNECTORS				SHEET No. 1 of 13
DOCUMENT NUMBER: PS-10-07		DOC TYPE: PS	DOC PART: 001	CREATED / REVISED BY: SS06	CHECKED BY: ISHWARGISHWARG	APPROVED BY: ISHWARGISHWAR

Crimp Housing	PCB Connector
	
Series: 2695	Series: 4455

Vertical Header	RA Header
	
Series: 4030	Series: 4094



Vertical Header with Friction Lock	Right Angle Header with Friction Lock
	
Series: 6373	Series: 7478





[KK 254 WEB PAGE](#)

[TABLE OF CONTENTS](#)

REVISION: T3	ECM INFORMATION: EC No: 617830617830 DATE: 2019/05/24201 05/24	TITLE: PRODUCT SPECIFICATION .100 CENTER KK CONNECTORS	SHEET No. 2 of 13
DOCUMENT NUMBER: PS-10-07	DOC TYPE: PS	DOC PART: 001	CREATED / REVISED BY: SS06
CHECKED BY: ISHWARGISHWARG		APPROVED BY: ISHWARGISHWAR	

Vertical Header with Friction Lock	Right Angle Header with Friction Lock
	
Series: 6410	Series: 7395

Header, Vertical, Breakaway with Friction Lock	Header, RA, Breakaway with Friction Lock
	
Series: 42227	Series: 42228



[KK 254 WEB PAGE](#)

[TABLE OF CONTENTS](#)

REVISION: T3	ECM INFORMATION: EC No: 617830617830 DATE: 2019/05/24201 <small>05/24</small>	TITLE: PRODUCT SPECIFICATION .100 CENTER KK CONNECTORS				SHEET No. 3 of 13
DOCUMENT NUMBER: PS-10-07		DOC TYPE: PS	DOC PART: 001	CREATED / REVISED BY: SS06	CHECKED BY: ISHWARGISHWARG	APPROVED BY: ISHWARGISHWAR

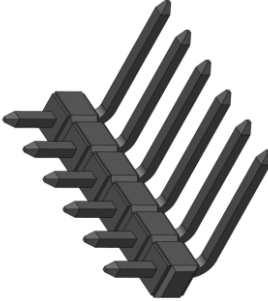
Header, Vertical, Breakaway	Header, RA, Breakaway
	
Series: 42375	Series: 42376

Header, Right-Angle, Breakaway, Surface Mount Compatible

Series: 42377



[KK 254 WEB PAGE](#)

[TABLE OF CONTENTS](#)

REVISION: T3	ECM INFORMATION: EC No: 617830617830 DATE: 2019/05/24201 <small>05/24</small>	TITLE: PRODUCT SPECIFICATION .100 CENTER KK CONNECTORS				SHEET No. 4 of 13
DOCUMENT NUMBER: PS-10-07		DOC TYPE: PS	DOC PART: 001	CREATED / REVISED BY: SS06	CHECKED BY: ISHWARGISHWARG	APPROVED BY: ISHWARGISHWAR

Table of Contents

1.0	SCOPE.....	6
2.0	PRODUCT DESCRIPTION.....	6
2.1	PRODUCT NAME AND SERIES NUMBER (S).....	6
2.2	DIMENSIONS, MATERIALS, PLATING AND MARKINGS.....	6
2.3	SAFETY AGENCY APPROVALS.....	6
3.0	APPLICABLE DOCUMENTS AND SPECIFICATION.....	7
3.1	MOLEX DOCUMENTS.....	7
3.2	INDUSTRY DOCUMENTS.....	7
4.0	ELECTRICAL PERFORMANCE RATINGS.....	8
4.1	VOLTAGE.....	8
4.2	CURRENT AND APPLICABLE WIRES.....	8
4.3	TEMPERATURE (AMBIENT +30°C TEMP).....	8
4.4	DURABILITY.....	8
5.0	QUALIFICATION.....	8
6.0	PERFORMANCE.....	9
6.1	ELECTRICAL PERFORMANCE.....	9
6.2	MECHANICAL PERFORMANCE.....	10
6.3	ENVIRONMENTAL PERFORMANCE.....	11
7.0	SOLDER INFORMATION.....	12
7.1	SOLDER PROCESS TEMPERATURES.....	12
8.0	PACKAGING.....	13
9.0	CABLE TIE AND/ OR TWIST LOCATION.....	13



[KK 254 WEB PAGE](#)

[TABLE OF CONTENTS](#)

REVISION: T3	ECM INFORMATION: EC No: 617830617830 DATE: 2019/05/24 2019/05/24	TITLE: PRODUCT SPECIFICATION .100 CENTER KK CONNECTORS				SHEET No. 5 of 13
DOCUMENT NUMBER: PS-10-07		DOC TYPE: PS	DOC PART: 001	CREATED / REVISED BY: SS06	CHECKED BY: ISHWARGISHWARG	APPROVED BY: ISHWARGISHWAR

1.0 SCOPE

This Product Specification covers the 2.54 mm (.100 inch) centerline (pitch) 0.64 mm (.025) square pin headers when mated with either printed circuit board (PCB) connectors or connectors terminated with 22 to 30 AWG wire using crimp technology.

2.0 PRODUCT DESCRIPTION

2.1 PRODUCT NAME AND SERIES NUMBER (S)

Description	Series
Crimp Terminals	2759 , 6459 , 41572 , 4809 , 8088
Crimp Housings	2695
PCB Connectors	4455
Headers	4030 , 4094 , 6373 , 7478 , 6410 , 7395 , 42225, 42226, 42227 , 42228 , 42375 , 42376 , 42377 , 4380, 42009, 43009, 46607

Other products conforming to this specification are noted on the individual drawings

2.2 DIMENSIONS, MATERIALS, PLATING AND MARKINGS

Terminal Material: Brass or Phos. Bronze (for Max performance use phos. bronze material.)

Housing: Nylon or Polyester

Pins: Brass or Phos. Bronze

For more information on dimensions, materials, and plating see the individual drawings.

RoHS compliant materials*.

*Refer to the "Product Environmental Compliance" section in Molex.com to know the individual PN RoHS compliance status

2.3 SAFETY AGENCY APPROVALS

2.3.1 UL File Number: E29179



2.3.2 File Number*: LR19980



[KK 254 WEB PAGE](#)

[TABLE OF CONTENTS](#)

REVISION: T3	ECM INFORMATION: EC No: 617830617830 DATE: 2019/05/24201 05/24	TITLE: PRODUCT SPECIFICATION .100 CENTER KK CONNECTORS	SHEET No. 6 of 13
DOCUMENT NUMBER: PS-10-07	DOC TYPE: PS	DOC PART: 001	CREATED / REVISED BY: SS06
CHECKED BY: ISHWARGISHWARG		APPROVED BY: ISHWARGISHWAR	

SERIES	Agency Voltage Rating (AC RMS or DC)		Agency Current Rating (Single Circuit) (Amps)		Agency Temperature Rating (°C)
	UL	CSA	UL	CSA	UL
2695	500 V AC 600 V DC	250	-	2.5	105°C
4455	600	250	-	2.5	105°C
4030	600	250	-	2.5	105°C
4094	600	250	-	2.5	105°C
6373	600	250	-	2.5	105°C
7478	600	250	-	2.5	105°C
6410	600	250	-	2.5	105°C
7395	600	250	-	2.5	105°C
42225	600	250	-	2.5	105°C
42226	600	250	-	2.5	105°C
42227	600	250	-	2.5	105°C
42228	600	250	-	2.5	105°C
42375	600	250	-	2.5	120°C
42376	600	250	-	2.5	120°C
42377	600	250	-	2.5	120°C

3.0 APPLICABLE DOCUMENTS AND SPECIFICATION

3.1 MOLEX DOCUMENTS

See series specific sales drawings and the other sections of this specifications for the necessary referenced documents and specifications.

Cosmetic Specification PS-45499-002

[Molex Quality Crimping Handbook Order No. 63800-0029](#)

[Molex Solderability Specification SMES-152](#)

[Molex Heat Resistance Specification AS-40000-5013](#)

[Molex Moisture Technical Advisory AS-45499-001](#)

[Molex Package Handling Specification 454990100-PK](#)

ATS – Application Tooling Specification*

*Application Tooling Specification for terminals is not provided in this document. ATS for terminals can be available from respective terminal part number page in Molex.com

3.2 INDUSTRY DOCUMENTS

EIA-364-1000.01

UL-1977

CSA STD. C22.2 NO. 182.3-M1987



[KK 254 WEB PAGE](#)

[TABLE OF CONTENTS](#)

REVISION: T3	ECM INFORMATION: EC No: 617830617830 DATE: 2019/05/24201	TITLE: PRODUCT SPECIFICATION .100 CENTER KK CONNECTORS	SHEET No. 7 of 13
DOCUMENT NUMBER: PS-10-07	DOC TYPE: PS	DOC PART: 001	CREATED / REVISED BY: SS06
CHECKED BY: ISHWARGISHWARG		APPROVED BY: ISHWARGISHWAR	

4.0 ELECTRICAL PERFORMANCE RATINGS

4.1 VOLTAGE

500 Volts AC (or 600 Volts DC)

4.2 CURRENT AND APPLICABLE WIRES

(Current is dependent on connector size, contact material, plating, ambient temperature, printed circuit board characteristics and related factors. Actual current rating is application dependent and should be evaluated for each application.)

AWG	Amps (Max.)	Outside Insulation Diameter
22	4.00	See Drawings
24	3.75	See Drawings
26	3.50	See Drawings
28	3.00	See Drawings
30	2.50	See Drawings

Note: current ratings are for a single circuit, based on not exceeding 30°C temperature rise

4.3 TEMPERATURE (AMBIENT +30°C TEMP)

	Brass Terminals	Phos Bronze Terminals
Operating Temperature	-40°C to +80°C*	-40°C to +105°C*
Non-Operating Temperature	-40°C to +105°C**	-40°C to +105°C

*including terminal temperature rise.

**parts not mated

4.4 DURABILITY

Tin / Gold plated: 25 mating cycles

As tested in accordance with EIA-364-1000.01 test method (see Sec. 6.2 of this specification).

5.0 QUALIFICATION

Laboratory conditions and sample selection are in accordance with EIA-364-1000.01



[KK 254 WEB PAGE](#)

[TABLE OF CONTENTS](#)

REVISION: T3	ECM INFORMATION: EC No: 617830617830 DATE: 2019/05/24201 05/24	TITLE: PRODUCT SPECIFICATION .100 CENTER KK CONNECTORS	SHEET No. 8 of 13
DOCUMENT NUMBER: PS-10-07	DOC TYPE: PS	DOC PART: 001	CREATED / REVISED BY: SS06
CHECKED BY: ISHWARGISHWARG		APPROVED BY: ISHWARGISHWAR	

6.0 PERFORMANCE

6.1 ELECTRICAL PERFORMANCE

DESCRIPTION	TEST CONDITION	REQUIREMENT
Contact Resistance (Low Level)	Mate connectors: apply a maximum voltage of 20 mV and a current of 100 mA.	10 milliohms MAXIMUM [initial]
Contact Resistance of Wire Termination (Low Level)	Terminate the applicable wire to the terminal and measure wire using a voltage of 20 mV and a current of 100 mA.	2 milliohms MAXIMUM [initial]
Insulation Resistance	Unmate & unmount connectors: apply a voltage of 500 VDC between adjacent terminals and between terminals to ground.	1000 Megohms MINIMUM
Dielectric Withstanding Voltage	Unmate connectors: apply a voltage of {two times the rated voltage plus 1000 volts} VAC for 1 minute between adjacent terminals and between terminals to ground.	No breakdown
Capacitance	Measure between adjacent terminals at 1 MHz.	2 picofarads MAXIMUM
Temperature Rise (via Current Cycling)	Mate connectors: measure the temperature rise at the rated current after: 1) 96 hours (steady state) 2) 240 hours (45 minutes ON and 15 minutes OFF per hour) 3) 96 hours (steady state)	Temperature rise: +30°C MAXIMUM



[KK 254 WEB PAGE](#)

[TABLE OF CONTENTS](#)

REVISION: T3	ECM INFORMATION: EC No: 617830617830 DATE: 2019/05/24201 05/24	TITLE: PRODUCT SPECIFICATION .100 CENTER KK CONNECTORS	SHEET No. 9 of 13
DOCUMENT NUMBER: PS-10-07	DOC TYPE: PS	DOC PART: 001	CREATED / REVISED BY: SS06
CHECKED BY: ISHWARGISHWARG		APPROVED BY: ISHWARGISHWAR	

6.2 MECHANICAL PERFORMANCE

DESCRIPTION	TEST CONDITION	REQUIREMENT
Connector Mate and Unmate Forces	Per circuit when mated to an .025 Sq. pin header without friction lock. Mate and unmate connector (male to female) at a rate of 25 ± 6 mm (1 ± ¼ inch) per minute.	4.9 N (1.1 lbf) MAXIMUM insertion force & 0.56 N (0.125 lbf) MINIMUM withdrawal force
Connector Mate and Unmate Forces 46856 series only	Per circuit when mated to a .093 thick PCB Mate and unmate connector at a rate of 25 ± 6 mm (1 ± ¼ inch) per minute.	6.67 N (1.5 lbf) MAXIMUM insertion force & 0.56 N (0.125 lbf) MINIMUM withdrawal force
Terminal Retention Force (in Housing)	Axial pullout force on the terminal in the housing at a rate of 25 ± 6 mm (1 ± ¼ inch) per minute. (Forces will change with platings and materials.)	17.8 N (4.0 lbf) MINIMUM withdrawal force
Terminal Insertion Force (into Housing)	Apply an axial insertion force on the terminal at a rate of 25 ± 6 mm (1 ± ¼ inch) per minute. (Forces will change with platings and materials.)	11.12 N (2.5 lbf) MAXIMUM insertion force
Durability	Mate connectors up to 25 cycles at a maximum rate of 10 cycles per minute prior to Environmental Tests.	10 milliohms MAXIMUM (change from initial)
Vibration (Sine)	Mate connectors and vibrate per EIA 364-28, test condition I.	10 milliohms MAXIMUM (change from initial) & Discontinuity < 1 microsecond
Shock (Mechanical)	Mate connectors and shock at 50 g's with ½ sine wave (11 milliseconds) shocks in the ±X, ±Y, ±Z axes (18 shocks total).	10 milliohms MAXIMUM (change from initial) & Discontinuity < 1 microsecond
Wire Pullout Force (Axial)	Apply an axial pullout force on the wire at a rate of 25 ± 6 mm (1 ± ¼ inch) per minute. (For maximum performance use Molex application tooling with stranded tinned copper wire)	Wire pullout force depends on crimp tooling. See relevant Molex Application Tooling Specification for requirements.
Normal Force	Apply a perpendicular force.	2.94 N (300 grams) average



[KK 254 WEB PAGE](#)

[TABLE OF CONTENTS](#)

REVISION: T3	ECM INFORMATION: EC No: 617830617830 DATE: 2019/05/24201	TITLE: PRODUCT SPECIFICATION .100 CENTER KK CONNECTORS	SHEET No. 10 of 13
DOCUMENT NUMBER: PS-10-07	DOC TYPE: PS	DOC PART: 001	CREATED / REVISED BY: SS06
CHECKED BY: ISHWARGISHWARG		APPROVED BY: ISHWARGISHWAR	

Kinked PC Pin Insertion Force (into PCB Hole)	Apply an axial insertion force on pins at a rate of 25 ± 6 mm (1 ± ¼ inch) per minute.	Number of kinked pins	Maximum Insertion force (per pin)	Average Insertion force (per pin)
		2	44.0 N (9.9 lbf)	15.1N (3.4 lbf)
		4	21.4 N (4.8 lbf)	9.8 N (2.2 lbf)
		6	18.2 N (4.1 lbf)	4.9 N (1.1 lbf)

6.3 ENVIRONMENTAL PERFORMANCE

DESCRIPTION	TEST CONDITION	REQUIREMENT										
Shock (Thermal)	Mate connectors; expose to 5 cycles of: <table border="1"> <tr> <th>Temperature °C</th> <th>Duration (Minutes)</th> </tr> <tr> <td>-40 +0/-3</td> <td>30</td> </tr> <tr> <td>+25 ±10</td> <td>5 MAXIMUM</td> </tr> <tr> <td>+105 +3/-0</td> <td>30</td> </tr> <tr> <td>+25 ±10</td> <td>5 MAXIMUM</td> </tr> </table>	Temperature °C	Duration (Minutes)	-40 +0/-3	30	+25 ±10	5 MAXIMUM	+105 +3/-0	30	+25 ±10	5 MAXIMUM	10 milliohms MAXIMUM (change from initial) & Visual: No Damage
Temperature °C	Duration (Minutes)											
-40 +0/-3	30											
+25 ±10	5 MAXIMUM											
+105 +3/-0	30											
+25 ±10	5 MAXIMUM											
Thermal Aging	Mate connectors; expose to: 96 hours at 105 ± 2°C	10 milliohms MAXIMUM (change from initial) & Visual: No Damage										
Humidity (Steady State)	Mate connectors: expose to a temperature of 40 ± 2°C with a relative humidity of 90-95% for 96 hours. Note: Remove surface moisture and air dry for 1 hour prior to measurements.	10 milliohms MAXIMUM (change from initial) & Dielectric Withstanding Voltage: No Breakdown at 500 VAC & Insulation Resistance: 1000 Megohms MINIMUM & Visual: No Damage										



[KK 254 WEB PAGE](#)

[TABLE OF CONTENTS](#)

REVISION: T3	ECM INFORMATION: EC No: 617830617830 DATE: 2019/05/24201	TITLE: PRODUCT SPECIFICATION .100 CENTER KK CONNECTORS	SHEET No. 11 of 13
DOCUMENT NUMBER: PS-10-07	DOC TYPE: PS	DOC PART: 001	CREATED / REVISED BY: SS06
CHECKED BY: ISHWARGISHWARG		APPROVED BY: ISHWARGISHWAR	

Humidity (Cyclic)	Mate connectors: cycle per EIA-364-31: 24 cycles at temperature $25 \pm 3^\circ\text{C}$ at $80 \pm 5\%$ relative humidity and $65 \pm 3^\circ\text{C}$ at $50 \pm 5\%$ relative humidity; dwell time of 1.0 hour; ramp time of 0.5 hours. {Note: Remove surface moisture and air dry for 1 hour prior to measurements.}	10 milliohms MAXIMUM (change from initial) & Dielectric Withstanding Voltage: No Breakdown at 500 VAC & Insulation Resistance: 1000 Megohms MINIMUM & Visual: No Damage
Solderability	Per SMES-152	Solder coverage: 95% MINIMUM (per SMES-152)
Solder Resistance	Dip connector terminal tails in solder: Solder Duration: 5 ± 0.5 seconds; Solder Temperature: $230 \pm 5^\circ\text{C}$	Visual: No Damage to insulator material
Cold Resistance	Mate connectors: Duration: 96 hours; Temperature: $-40 \pm 3^\circ\text{C}$	10 milliohms MAXIMUM (change from initial) & Visual: No Damage
Corrosive Atmosphere: Flowing Mixed Gas (FMG)	Test per EIA-364-65, Class II, Exposure to gasses for 4 days, unmated.	10 milliohms MAXIMUM (change from initial) & Visual: No Damage

7.0 SOLDER INFORMATION

7.1 SOLDER PROCESS TEMPERATURES

Wave Solder: 235°C MAX

[Molex Solderability Specification SMES-152](#)
(Click Here)



[KK 254 WEB PAGE](#)

[TABLE OF CONTENTS](#)

REVISION: T3	ECM INFORMATION: EC No: 617830617830 DATE: 2019/05/24201	TITLE: PRODUCT SPECIFICATION .100 CENTER KK CONNECTORS	SHEET No. 12 of 13
DOCUMENT NUMBER: PS-10-07	DOC TYPE: PS	DOC PART: 001	CREATED / REVISED BY: SS06
CHECKED BY: ISHWARGISHWARG		APPROVED BY: ISHWARGISHWAR	

8.0 PACKAGING

Parts shall be packaged to protect against damage during normal handling, transit and storage. "For specific part packaging details, refer to the packaging specification called out on the applicable product sales drawing.

9.0 CABLE TIE AND/ OR TWIST LOCATION

Circuit Sizes			Dimension T Minimum
2	4	6	0.50" (12.7mm)
8			0.75" (19.1mm)
10	12		1.00" (25.40mm)
14	16		1.25" (31.75mm)
18	20		1.50" (38.09mm)
22	24		1.75" (44.45mm)

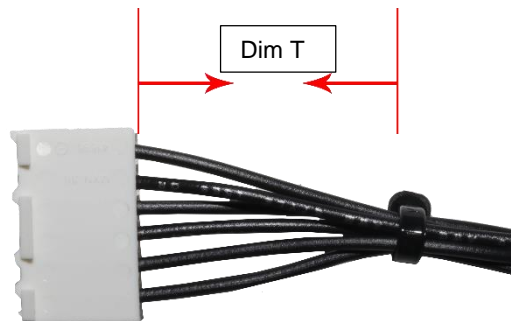

The "T" dimension defines a "free" length of wire, or a length of wire that is not subject to significant bias by external factors such as a wire tie, wire twisting, or other means of bending or deforming of the wires that repositions them from their natural relaxed state or location where they enter the housing. Wires are to be dressed in such a manner to allow the terminals to float freely in the pocket. This dimension is general recommendation and may need to be adjusted for different wire gauges and wire type and insulation thickness and insulation material.



[KK 254 WEB PAGE](#)

[TABLE OF CONTENTS](#)

REVISION: T3	ECM INFORMATION: EC No: 617830617830 DATE: 2019/05/24201	TITLE: PRODUCT SPECIFICATION .100 CENTER KK CONNECTORS	SHEET No. 13 of 13
DOCUMENT NUMBER: PS-10-07	DOC TYPE: PS	DOC PART: 001	CREATED / REVISED BY: SS06
CHECKED BY: ISHWARGISHWARG		APPROVED BY: ISHWARGISHWAR	