



2111 Comprehensive Drive

Aurora, Illinois 60505

Phone: 630-851-4722

Fax: 630-851-5040

www.conwin.com

Precision TCXO / VCTCXO Models DOT050F / DOT050V

CONNOR WINFIELD



Description:

The Connor-Winfield's DOT050F / DOT050V are Surface Mount, 9x14mm, 3.3V, LVCMOS Temperature Compensated Crystal Oscillator (TCXO / VCTCXO) designed for applications requiring very tight frequency stability and low phase noise. The RoHS compliant true surface mount package is designed for high-density mounting and is optimum for mass production.

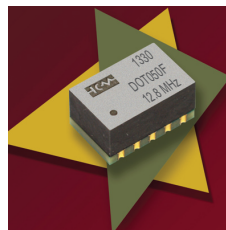

Features:

TCXO Model: DOT050F
VCTCXO Model: DOT050V

- 3.3 Vdc Operation
- Frequency Stability: ± 50 ppb
- Temperature Range: 0 to 70°C
- LVCMOS Output Logic
- 9x14mm SMT Package
- Tape and Reel Packaging
- RoHS Compliant / Pb Free

Absolute Maximum Ratings

Parameter	Minimum	Nominal	Maximum	Units	Notes
Storage Temperature	-55	-	125	°C	
Supply Voltage (Vcc)	-0.5	-	4.5	Vdc	
Input Voltage	-0.5	-	Vcc+0.5	Vdc	

Absolute Ratings: Stresses beyond those listed under "absolute maximum ratings" may cause permanent damage to the device. These are stress ratings only. The functional operation of the device at those or any other conditions beyond those indicated under "recommended operating conditions" is not implied. Exposure to conditions outside the "recommended operating conditions" for any extended period of time may adversely impact device reliability and result in failures not covered by warranty.

Operating Specifications

Parameter	Minimum	Nominal	Maximum	Units	Notes
Frequencies Available (Fo)	-	10, 12.8, 19.2, 19.44 or 20	-	MHz	
Frequency Calibration @ 25 °C	-1.0	-	1.0	ppm	1
Frequency Stability	-50	-	50	ppb	2
Aging / Day	-10	-	10	ppb	3
Aging / First Year	-300	-	300	ppb	
Total Frequency Tolerance	-4.6	-	4.6	ppm	4
Frequency vs. Load Stability	-20	-	20	ppb	$\pm 5\%$, 5
Frequency vs. Voltage Stability	-20	-	20	ppb	$\pm 5\%$
Operating Temperature Range:	0	-	70	°C	
Supply Voltage (Vcc)	3.135	3.3	3.465	Vdc	$\pm 5\%$
Supply Current	-	6	10	mA	
Period Jitter	-	3	5	ps rms	
Integrated Phase Jitter (12 KHz to Fo/2)	-	0.5	1.0	ps rms	
Short Term Stability	-	-	1.0E-9/s		
SSB Phase Noise Fo = 12.8 MHz					
@ 1Hz offset	-	-70	-	dBc/Hz	
@ 10Hz offset	-	-100	-	dBc/Hz	
@ 100Hz offset	-	-130	-	dBc/Hz	
@ 1KHz offset	-	-148	-	dBc/Hz	
@ 10KHz offset	-	-154	-	dBc/Hz	
@ 100KHz offset	-	-155	-	dBc/Hz	
Start-up Time	-	-	10	ms	

Notes:

1. Frequency referenced to Fo @ 25°C, for VCTCXO models Vc = 1.65V
2. Frequency stability vs. change in temperature. $[\pm(F_{max} - F_{min})/(2 \cdot F_o)]$.
3. After 30 days of operation.
4. Inclusive of calibration @25°C, frequency vs. change in temperature, change in supply voltage($\pm 5\%$), load change($\pm 5\%$) and 15 years aging.
5. Referenced to 15 pF.





Ordering Information

TCXO:	DOT050F-010.0M, DOT050F-012.8M, DOT050F-019.2M, DOT050F-019.44M or DOT050F-020.0M
VCTCXO:	DOT050V-010.0M, DOT050V-012.8M, DOT050V-019.2M, DOT050V-019.44M or DOT050V-020.0M

DOT050V Models Input Characteristics

Parameter	Minimum	Nominal	Maximum	Units	Notes
Control Voltage (Vc)	0.3	1.65	3.0	Vdc	
Tuning Frequency	±10.0	-	-	ppm	
Input Impedance	100K	-	-	Ohm	
Linearity	±5	-	-	%	
Slope			Positive		

LVC MOS Output Characteristics

Parameter	Minimum	Nominal	Maximum	Units	Notes
Load	-	15	-	pF	
Output Voltage (High) (Voh)	90% Vcc	-	-	Vdc	
(Low) (Vol)	-	-	10% Vcc	Vdc	
Output Current (Ioh)	-	-	4	mA	
(Iol)	-4	-	-	mA	
Duty Cycle at 50% of Vcc	45	50	55	%	
Rise / Fall Time 10% to 90%	-	4	8	ns	

Package Characteristics

Package consisting of a FR4 substrate and a Ryton-R4 cover. Water Resistant, non-hermetic seal

Soldering Characteristics

RoHS compliant lead free. See soldering profile on page 4.

Recommended Cleaning Process

Wash only in an in-line high pressure wash station that has an air knife and drying capabilities.
(Drying temperature range from 85° to 100°C)

Environmental Characteristics

Shock	500 G's 1ms, Half sine, 3 shocks per direction, per MIL- STD 202F, Method 213B Test Condition D.
Sinusoidal Vibration	0.06" D.A. or 10G's Peak, 10 to 500 Hz, per MIL-STD 202F, Method 204D, Test Condition A.
Random Vibration	5.35 G's rms. 20 to 2000 Hz per MIL-STD-202F, Method 214, Test Condition 1A, 15 minutes each axis.
Moisture	10 cycles, 95% RH, Per MIL-STD-202F, Method 112.
Marking Permanency	Per MIL-STD-202F, Method 215J.

Bulletin	TX395
Page	2 of 4
Revision	04
Date	06 May 2019

Package Layout

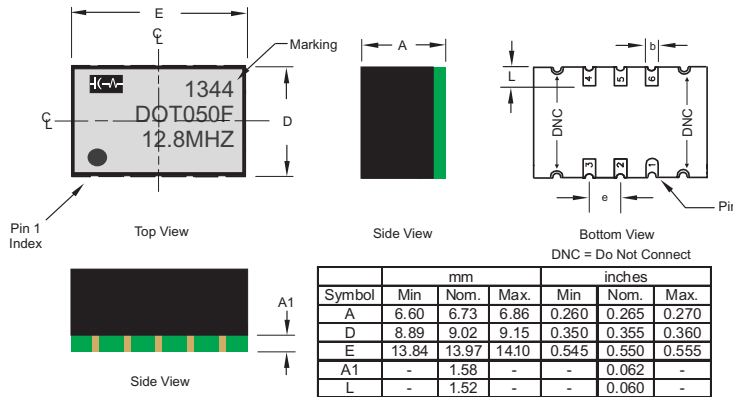

Suggested Pad Layout

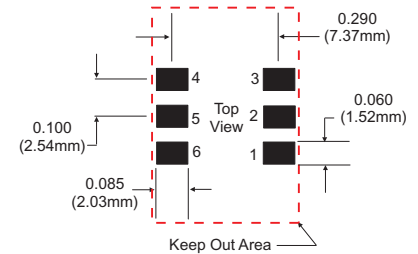

Keep Out Area Note: Do not route any traces under the device in the keep out area.

Phase Noise Plot

DOT050F-012.8M Typical Phase Noise

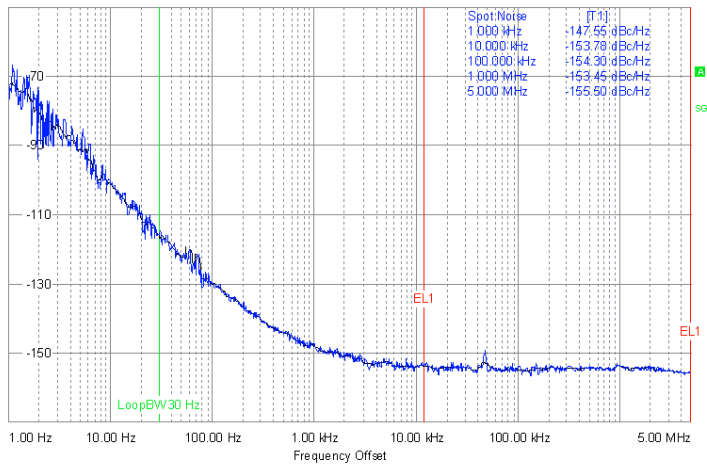

Pad Connections

- 1: TCXO = N/C, VCTCXO = Vc
- 2: Do Not Connect
- 3: Ground
- 4: Output
- 5: Do Not Connect
- 6: Supply Voltage (Vcc)

Output Waveform

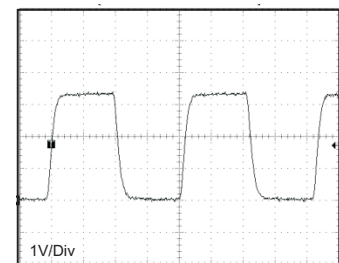

Test Circuit

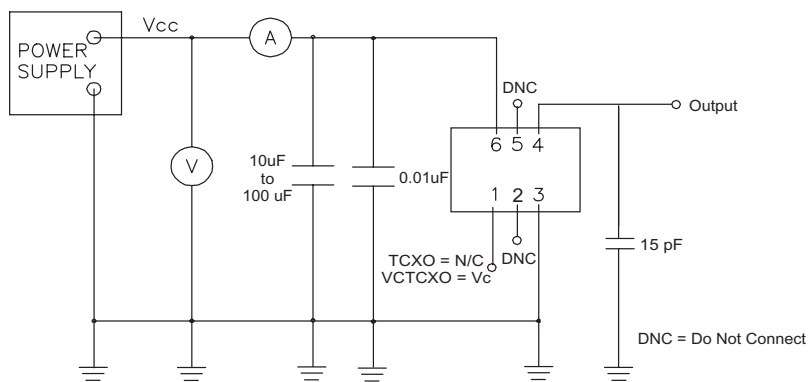

Tape and Reel Dimensions

MEETS EIA-481A & EIAJ-1009B

500 PCS/REEL MAXIMUM

→ DIRECTION OF FEED (CUSTOMER)

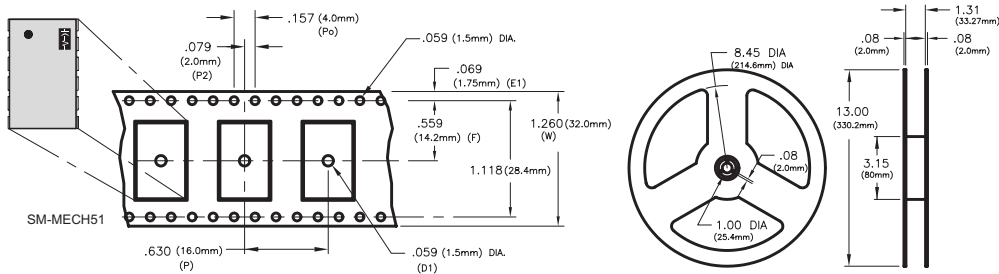

Solder Profile

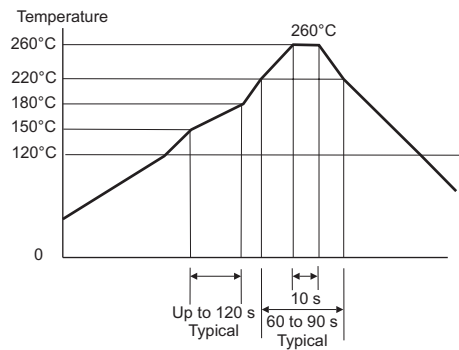

Meets IPC/JEDEC J-STD-020C

Revision History

Revision	Date	Description
00	7/12/13	Data sheet released.
01	09/17/13	Updated package drawing and suggested layout to IPC
02	02/26/14	Updated with Digi-Key Information
03	09/29/14	Total Frequency Tolerance updated
04	05/06/19	Updated Tape and Reel Specifications

Bulletin	TX395
Page	4 of 4
Revision	04
Date	06 May 2019