

DC-Filter, dual pole



See below:  
[Approvals and Compliances](#)

### Description

- Line-filter in standard version
- 1-stage
- standard attenuation

### Characteristics

- Optimized for DC supplied applications
- Suitable for use in equipment according to IEC/UL 62368-1

### Other versions on request

- Other terminal combinations
- Version with wire connection

### References

Alternative: Standard version

### Weblinks

[pdf data sheet](#), [html datasheet](#), [General Product Information](#), [Approvals](#), [Distributor-Stock-Check](#), [Detailed request for product](#), [Microsite](#)

### Technical Data

Ratings IEC	5 - 30A @ Ta 40 °C / ±80VDC
Ratings UL/CSA	5 - 30A @ Ta 40 °C / ±80VDC
Dielectric Strength	> 1.7 kVDC between Vss-GND > 2.7 kVDC between Vss/GND-PE Test voltage (2 sec)
Allowable Operation Temperature	-25°C to 100°C
Climatic Category	25/100/21 acc. to IEC 60068-1
Protection Class	Suitable for appliances with protection class I acc. to IEC 61140
Terminal	Quick connect / screw terminals
Material	Aluminum, UL 94V-0

Line Filter	Industrial version, IEC 60939, UL 1283, CSA C22.2 no. 8 <a href="#">Technical Details</a>
MTBF	> 200'000h acc. to MIL-HB-217 F

### Approvals and Compliances



Detailed information on product approvals, code requirements, usage instructions and detailed test conditions can be looked up in [Details about Approvals](#)

SCHURTER products are designed for use in industrial environments. They have approvals from independent testing bodies according to national and international standards. Products with specific characteristics and requirements such as required in the automotive sector according to IATF 16949, medical technology according to ISO 13485 or in the aerospace industry can be offered exclusively with customer-specific, individual agreements by SCHURTER.

### Approvals





The approval mark is used by the testing authorities to certify compliance with the safety requirements placed on electronic products.

Approval Reference Type: FMEC

Approval Logo	Certificates	Certification Body	Description
	<a href="#">VDE Approvals</a>	VDE	Certificate Number: 40020247
	<a href="#">UL Approvals</a>	UL	UR File Number: E72928

**Product standards**

Product standards that are referenced

Organization	Design	Standard	Description
	Designed according to	IEC 60939	Passive filters for suppressing electromagnetic interference
	Designed according to	IEC 60127-6	Miniature fuses. Part 6. Fuse-holders for miniature fuse-links
	Designed according to	UL 1283	Electromagnetic interference filters
	Designed according to	CSA C22.2 no. 8	Electromagnetic interference (EMI) filters





**Application standards**

Application standards where the product can be used

Organization	Design	Standard	Description
	Suitable for applications acc.	IEC/UL 62368-1	Audio/video, information and communication technology equipment - Part 1: Safety requirements

**Compliances**

The product complies with following Guide Lines

Identification	Details	Initiator	Description
	<a href="#">CE declaration of conformity</a>	SCHURTER AG	The CE marking declares that the product complies with the applicable requirements laid down in the harmonisation of Community legislation on its affixing in accordance with EU Regulation 765/2008.
	<a href="#">UKCA declaration of conformity</a>	SCHURTER AG	The UKCA marking declares that the product complies with the applicable requirements laid down in the British Amendment of Regulation (EC) 765/2008.
	RoHS	SCHURTER AG	Directive RoHS 2011/65/EU, Amendment (EU) 2015/863
	China RoHS	SCHURTER AG	The law SJ / T 11363-2006 (China RoHS) has been in force since 1 March 2007. It is similar to the EU directive RoHS.
	REACH	SCHURTER AG	On 1 June 2007, Regulation (EC) No 1907/2006 on the Registration, Evaluation, Authorization and Restriction of Chemicals 1 (abbreviated as "REACH") entered into force.

**Dimension [mm]**

Case 86-3

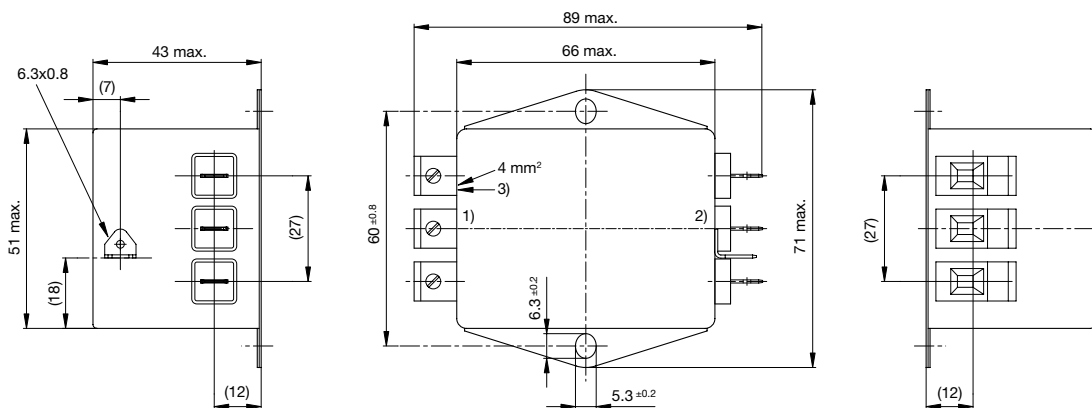

- 1) Line
- 2) Load
- 3) I/O connections torque 0.6...0.8 Nm

Case 87-3

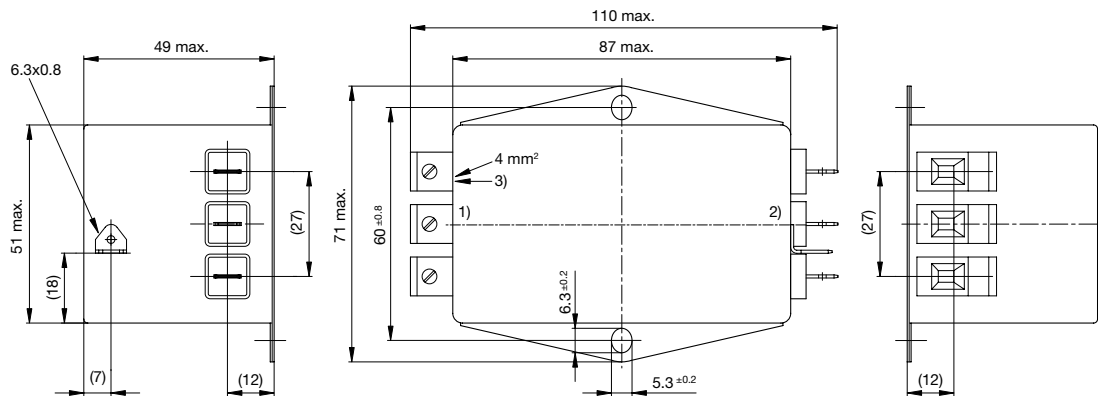

- 1) Line
- 2) Load
- 3) I/O connections torque 0.6...0.8 Nm

Case 87-7

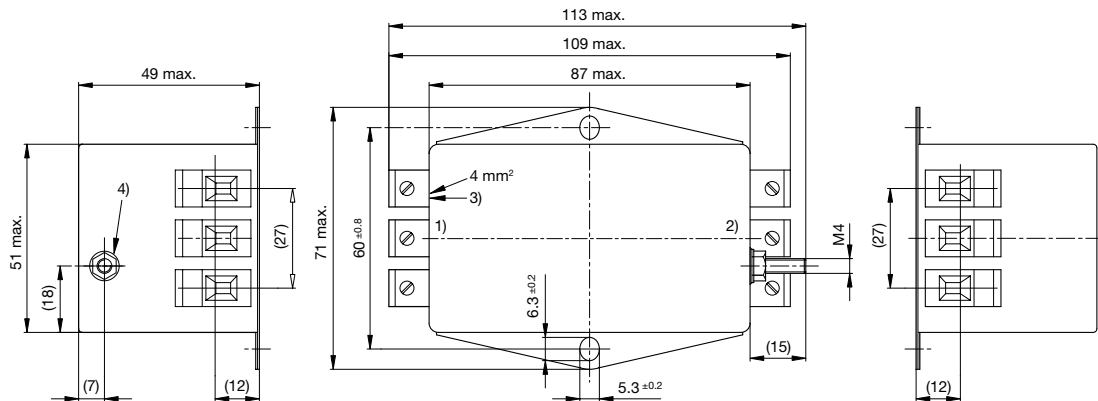

- 1) Line
- 2) Load
- 3) Tightening torque 0.6...0.8 Nm
- 4) Tightening torque 1.2...1.4 Nm

Terminal options

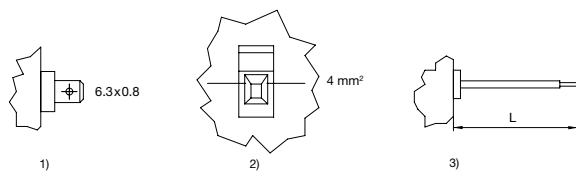

- 1) Quick connect terminals 6.3x0.8 (only up to 24A)
- 2) Screw clamp 4mm<sup>2</sup>
- 3) Flexible wires

Diagrams

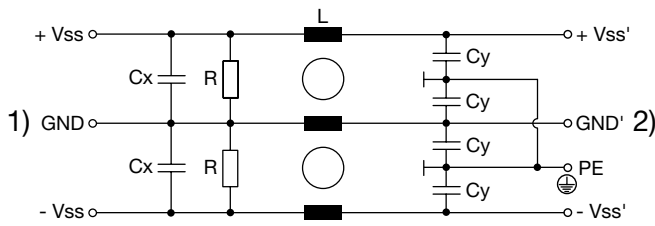

1) Line  
 2) Load

Attenuation Loss

--- 50Ω differential mode    50Ω common mode

Standard version

30 A

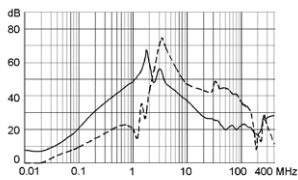

24 A

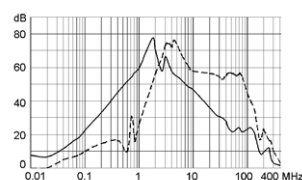

20 A

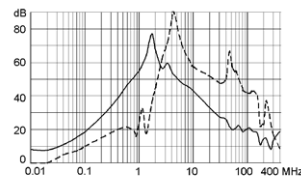

15 A

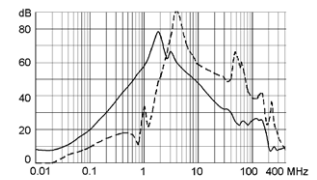

10 A

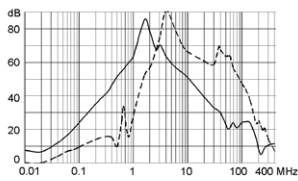

5 A

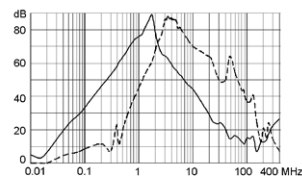

All Variants

Rated Current [A]	L [mH]	Cx (X2) [nF]	Cy (Y2) [nF]	R [MΩ]	Weight [g]	Housing	Packaging unit	Order Number
5	3 x 0.75	100	100	1	245 g	86-3	10	5500.2229
10	3 x 0.2	100	100	1	245 g	86-3	10	5500.2230
15	3 x 0.1	100	100	1	250 g	86-3	10	5500.2231
20	3 x 0.07	100	100	1	260 g	86-3	10	5500.2232
24	3 x 0.14	100	100	1	400 g	87-3	4	5500.2233
30	3 x 0.08	100	100	1	425 g	87-7	4	5500.2234

Availability for all products can be searched real-time: <https://www.schurter.com/en/Stock-Check/Stock-Check-SCHURTER>