

### 1. Mechanical Dimensions:

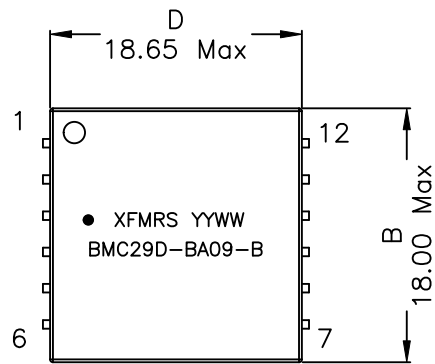

Top View

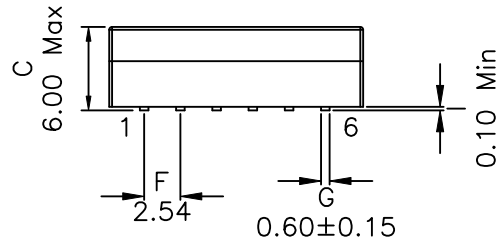
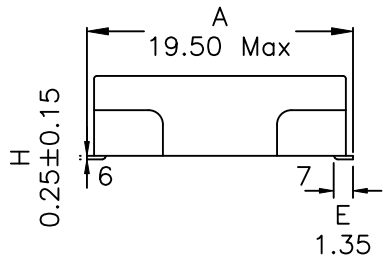
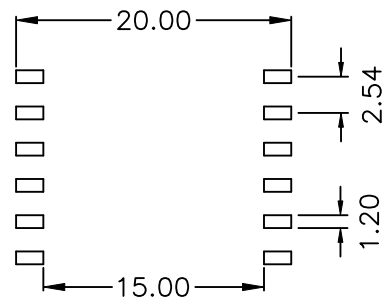

Suggested PCB Layout

### 2. Schematic:

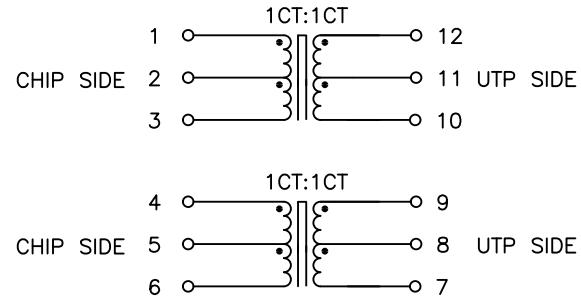

### 3. Electrical Specifications: @25°C

- UTP Impedance: 100 OHMS
- Turns Ratio: (CHIP : UTP)=1CT:1CT±2%
- Isolation Voltage: 2900Vac, CHIP SIDE to UTP SIDE
- UTP Side OCL: 350uH Min @100KHz 0.1V, 8mAdc
- UTP Side Q: 5 Min @100KHz 0.1V,
- Rise Time (10-90%): 4.0ns Typical
- Insertion Loss (1-100MHz): -1.0dB Maximum
- Return Loss: 30MHz 60MHz 80MHz  
-20dB -14dB -11.5dB Typ
- CMRR: 30MHz 50MHz 100MHz  
-42dB -37dB -33dB Typ

Notes:

1. Solderability: Leads shall meet MIL-STD-202G, Method 208H for solderability.
2. Flammability: UL94V-0
3. ASTM oxygen index: > 28%
4. Insulation System: Class F 155°C. UL file E151556
5. Operating Temperature Range: -40°C to +125°C
6. Storage Temperature Range: -55°C to +125°C
7. Aqueous wash compatible
8. SMD Lead Coplanarity: ±0.004"(0.102mm)
9. Electrical and mechanical specifications 100% tested
10. RoHS Compliant Component
11. Recommended IR Reflow peak temp of 245°C Max.

DOC. REV: A/2

<b>XFMRs</b> <sup>®</sup> <a href="http://www.XFMRS.com">www.XFMRS.com</a>	Title: <b>TRANSFORMER</b>		
	UNLESS OTHERWISE SPECIFIED	P/N: XFBMC29DNC-BA09-A	REV. A
TOLERANCES: .xx ±0.25	DWN.	Yu	Aug-06-20
Dimensions in MM	CHK.	YK Liao	Aug-06-20
SHEET 1 OF 1	APP.	DDC	Aug-06-20

# XFMRs

## Recommended Infrared Reflow Temperature Profile for RoHS Compliant Parts

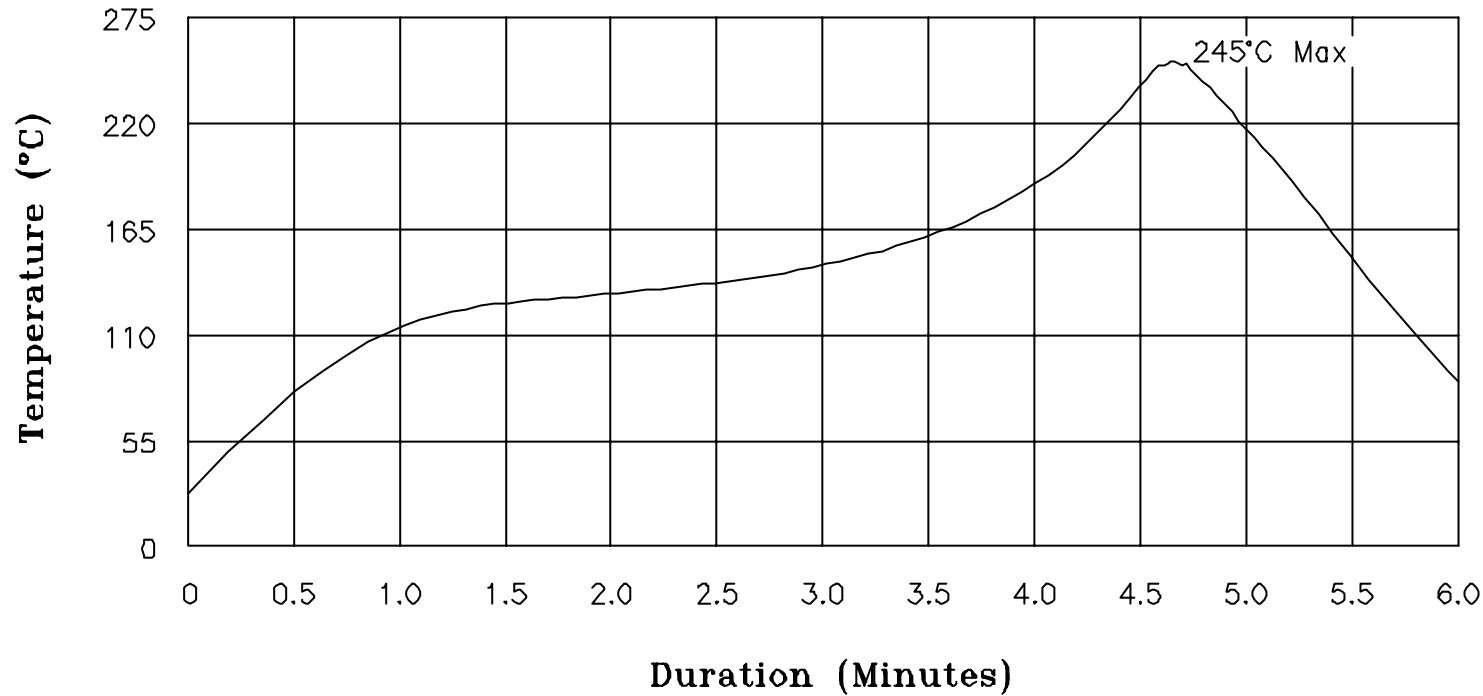

NOTES: Maximum duration at 245°+0/-5° shall be 10-15 seconds.  
 Maximum duration above 217° shall be 50-120 seconds.  
 ALL Temperatures refer to topside of the package, measured on the package body surface.

<b>XFMRs Inc</b> www.XFMRs.com	Title: <b>IR REFLOW CHART</b> <b>(RoHS Compliant parts)</b>			
	UNLESS OTHERWISE SPECIFIED TOLERANCES: N/A		P/N: N/A	REV. A
	DWN.	Juan Mao	Dec-20-06	
	CHK.	YK Liao	Dec-20-06	
SHEET 1 OF 1	APP.	Joe Huff	Dec-20-06	

CONCEPT

**GENERAL INFORMATION**

Part Number:	95-BMC29-D1-YK
Part Description:	BMC29D
Weight (lbs.):	0.00493 lbs.approx
T&R Notes:	1) PROCESS IN ACCORDANCE WITH EIA-461-2 STANDARDS * TAPE LEADER DIMENSION 15.30" MIN. * TAPE TRAILER DIMENSION 6.30" MIN. 2) PARTS SHOULD BE PACKAGED IN ACCORDANCE WITH ESD GUIDELINES IN EIA-541. 3) REEL LABEL: 'A' * PART NUMBER * QUANTITY * DATE CODE

**SUPPLIER INFORMATION**

Company Name:	XFMRs
Address Line 1:	UNIT G-J, 3/F, BLK 1, GOLDEN DRAGON IND CTR
State / ZIP:	152-160 TAI LIN PAI ROAD
Country:	HONG KONG, CHINA
Program Manager:	Kitty Lai
Contact E-mail:	<a href="mailto:klai@xfmrs.com.hk">klai@xfmrs.com.hk</a>
Contact Phone:	852 2423 1689

**PRIMARY PACKAGING**

Packaging Type:	PST&R			
Dimensions(cm):	L 33.0	W 33.0	H 3.2	
Weight:	1.08 lbs. approx			
QPC (Parts Per Reel)	350 pcs.			
Total Weight w/parts:	2.80 lbs.			
Banding / Shrink / Wrap:	BOPP Wrap			
Other:	N/A			

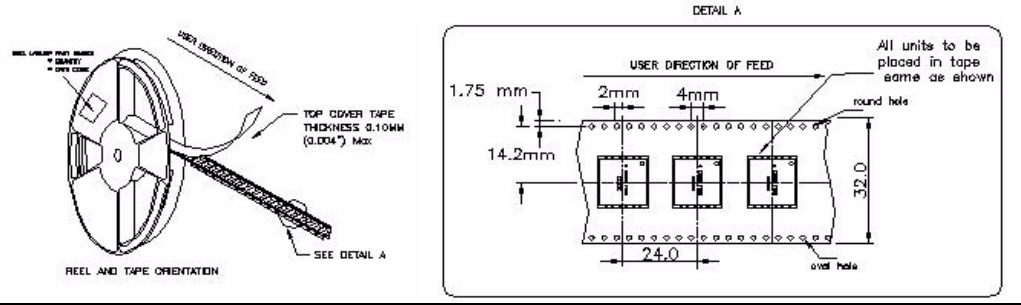

**SECONDARY PACKAGING**

Packaging Type:	Paper Box			
Dimensions(cm):	L 36.5	W 36.5	H 36.0	
Weight:	1.89 lbs.			
Boxes per Unit Load:	2800 pcs.			
Total weight w/Parts (lbs):	24.81 lbs.approx			
Banding / Shrink / Wrap:	BOPP Wrap / PP Banding			
Other:	N/A			

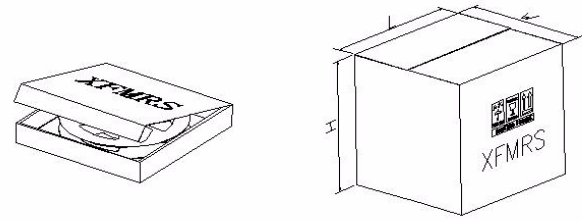

**SHIPPING INFORMATION**

Packaging Type:	PE Pallet			
Unit Load dims(cm):	L 120	W 100	H 161	
Weight:	16.72 lbs.			
Number of box Loads:	24 box.			
Number of Parts:	67200 pcs.			
Load weight total (lbs):	612.27 lbs.approx			
Banding / Shrink / Wrap:	PE Shrink			

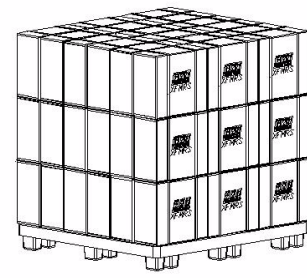

**PACKAGING APPROVAL**

Internal Document Manufacture / Q.A ./ Process Instructions	Drafted	Checked	Approved	Rev	Date
	Kong	Liao		A/1	Aug-07-20