

RoHS
REACH

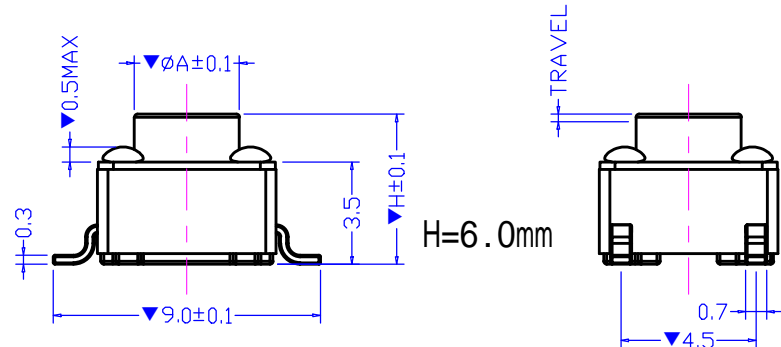
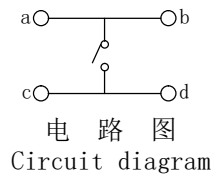

行程 (TRAVEL)	
250gf	0.25mm
180gf	0.20mm
100gf	

备注:

1. 塑料件表面应光滑整洁, 无飞边、气泡、收缩、破裂等缺陷, 铆点无脱落、开花、大小不一等缺陷;
2. 端子表面应清洁, 无锈蚀、变形、发黄、电镀不良等缺陷; 盖板应组装到位、无松动;
3. ▼重要尺寸首件/自主/巡回等均需确认;
4. 机械性能:
 - 5.1. 动作力: $250 \pm 50 \text{ gf} / 180 \pm 50 \text{ gf} / 100 \pm 50 \text{ gf}$;
 - 5.2. 寿命: 覆银铜弹片 50,000 CYCLES Min.; 不锈钢弹片 100,000 CYCLES Min.;

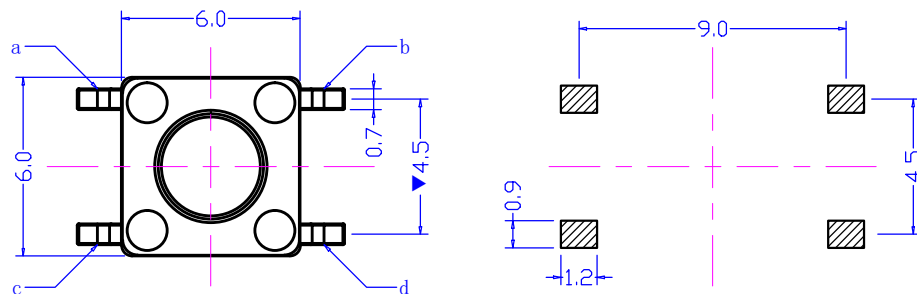
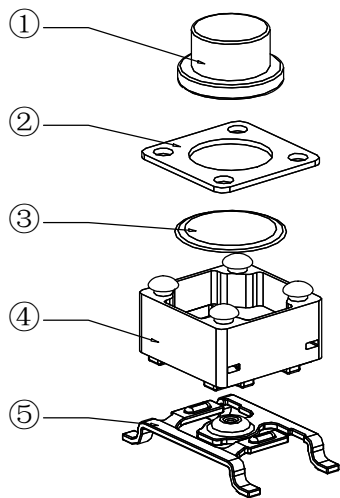

线路板图
PCB Diagram

A (直径)	H (高度)
$\phi 3.50$	4.3
	4.5
	4.7
	4.8
	5.0
$\phi 3.45$	5.5
$\phi 3.35$	6.0
$\phi 3.20$	6.5
$\phi 3.10$	7.0
	7.5
	8.0
	8.5
	9.0
	9.5
	10.0
	10.5
	11.0
	11.5
	12.0
	12.5
	13.0
	13.5
	14.0
	14.5
	15.0
	15.5
$\phi 3.00$	16.0
	16.5
	17.0
	17.5
	18.0
	18.5
	19.0
	19.5
	20.0
	21.0
	22.0
	23.0
	24.0
	25.0
	26.0
	27.0
	28.0
	29.0

序号	产品名称	材料规格	表面处理/颜色	数量	电气性能		未注尺寸公差 (mm)		设计		吴宏伟	产品名称: 轻触开关 6*6*6.0mm 贴片轻触开关
					额定规格	DC12V/50mA	.X	± 0.25	图面	A4		
1	按钮	PPA		1	接触电阻	$\leq 100 \text{ m}\Omega$.XX	± 0.15	单位	MM	标准化	胡文阳
2	盖板	铁/铜	镀铜锡	1	绝缘电阻	$\geq 100 \text{ M}\Omega$.XXX	± 0.05	页码	1/1		
3	弹片	覆银铜/不锈钢	镀银/无	1	耐电压	AC250V/min	角度	$\pm 1.5^\circ$	版次	A/0	批准	张旭敏
4	基座	PPA	黑色	1	东莞市康深电子科技有限公司							
5	嵌件	高精铜	镀铜锡	1								

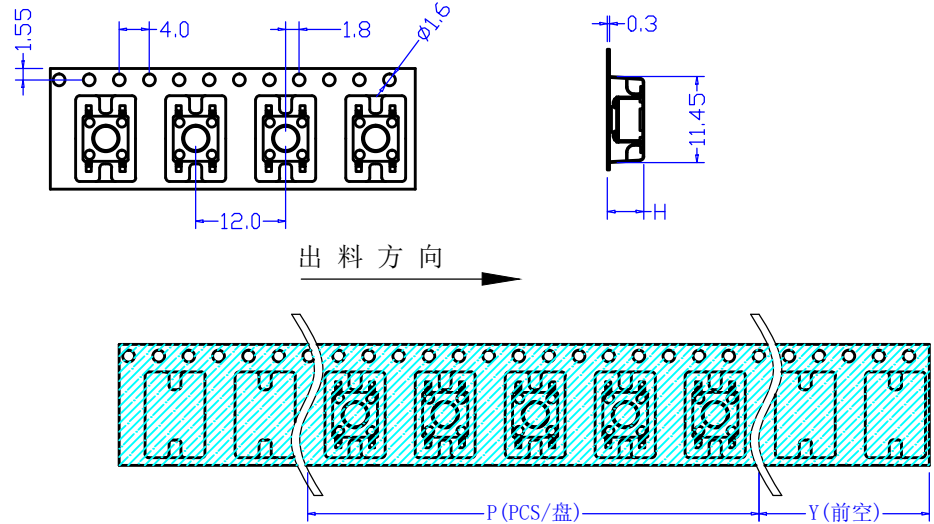
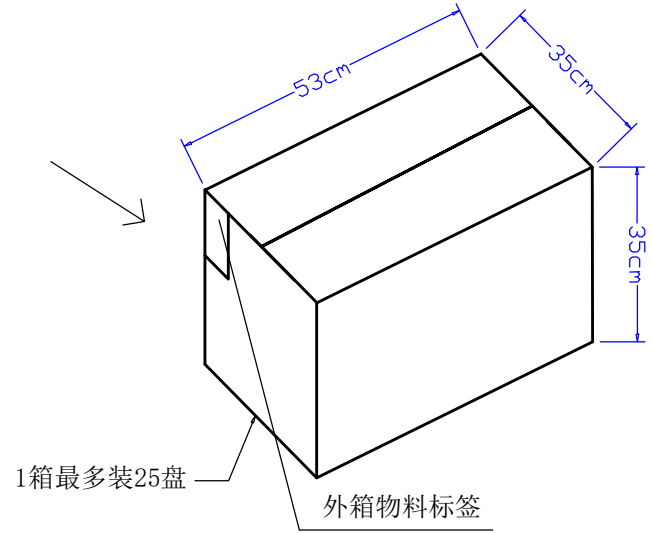
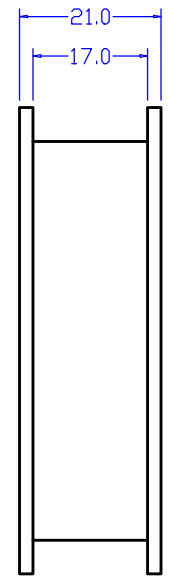
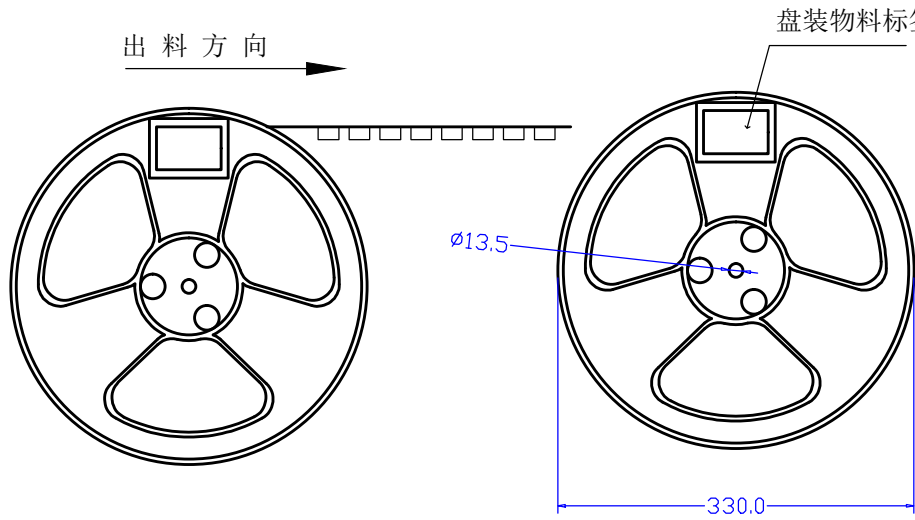

产品规格	H (高度)	P (PCS/盘)	Y (前空)
6x6x4.3	4.8mm	1000PCS	16PCS
6x6x4.5	5.0mm		
6x6x4.7	5.2mm		
6x6x4.8	5.5mm		
6x6x5.0	5.5mm		
6x6x5.5	6.0mm		
6x6x6.0	6.5mm	800PCS	
6x6x6.5	7.3mm		
6x6x7.0	7.3mm		
6x6x7.5	7.8mm	700PCS	
6x6x8.0	8.3mm		
6x6x8.5	8.8mm		
6x6x9.0	9.3mm	500PCS	
6x6x9.5	9.8mm		
6x6x10.0	10.3mm		
6x6x10.5	10.8mm		
6x6x11.0	11.3mm	400PCS	
6x6x11.5	11.8mm		
6x6x12.0	12.3mm		
6x6x12.5	12.8mm	350PCS	
6x6x13.0	13.3mm		
6x6x13.5	13.8mm		
6x6x14.0	14.3mm		
6x6x14.5	14.8mm		

未注尺寸公差 (mm)			设计	吴宏伟	产品名称: 轻触开关包装	
.X	±0.25		图面	A4	审核	郑程磊
.XX	±0.15	单位	MM	标准化	胡文阳	
.XXX	±0.05	比例	1:1		页码	1/1
角度	±1°	页码	1/1	批准	张旭敏	
		版次	A/0			