

客户 (Customer): _____

发行编号: J.SPC.50.59-008

发行日期: 2018.09.10

发行区分: 新规 改定

规格承认书

SPECIFICATION FOR APPROVAL

产品名称: 6.2X6.2X4.3 IP67

贵司型号: _____

敝司型号: TVEM17-043CW-R

接受印 ACKNOWLEDGEMENT	兹证明此份材料已经收到。 WE ACKNOWLEDGE RECEIVING THIS DOCUMENT. MONTH / DAY / YEAR DATE: / /		
G. MGR	LEADER	CHECKED	SIGNED

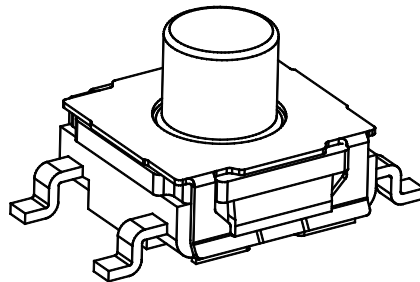

浙江键富电子有限公司
ZHEJIANG JIANFU ELECTRONICS CO., LTD

地址:浙江省乐清市天成工业区宁康东路 2892 号
TEL: 0577-61302509 61302221
FAX: 0577-61300308 61301196

JIANFU

发行部门: 技术部 TEL: 0577-61302509转8090 FAX: 0577-61300308			
拟制	核对	审核	批准
			

规格承认书				规格书编号 J.SPC.50.59-008
品名	6.2X6.2X4.3 IP67	型号	TVEM17-043CW-R	1/10

1. General Specification 基本说明

1.1 Scope 范围 This specification covers the requirements for single key switches which have no Key top(TACT SWITCHES:MECHANICAL CONTACT).此规范含盖单推柄和无推柄的轻触开关要求

1.2 Operating Temperature Range 使用温度范围
-40°C to +85°C (normal humidity, normal press.) 正常湿度, 标准压力

1.3 Storage Temperature Range 保存温度范围
-40 to +85°C (normal humidity, normal press.)

1.4 Test Conditions 测试条件

Tests and measurements shall be made in the following standard conditions unless otherwise specified: 测试和计量按下列标准条件除非特殊说明

Normal temperature (temperature 5 to 35°C) 标准温度

Normal humidity (relative humidity 25 to 85%) 正常湿气

Normal air pressure (Air pressure 86 to 106 kPa) 标准气压

In case any question arises from the judgment made, tests shall be conducted in the following conditions:

Temperature (20 ± 2°C) 温度

Relative humidity (65 ± 5%) 相对湿度

Air Pressure (86 to 106 kPa) 气压

2. Type Of Actuation 动作类型

 Tactile feedback 轻触返回

3. Contact Arrangement 1 poles 1 throws 接触形式 1 接点 1 回路

(Details of contact arrangement are given in the assembly drawings.)
细接点形式在装配图中

4. Maximum Ratings DC 12 V 50 mA 最大额定值

DC 1 V 10 μA 最小额定值

规格承认书

规格书编号
J.SPC.50.59-008

品名

6.2X6.2X4.3 IP67

型号

TVEM17-043CW-R

2/10

5. 外形、结构:

5.1 外形图:

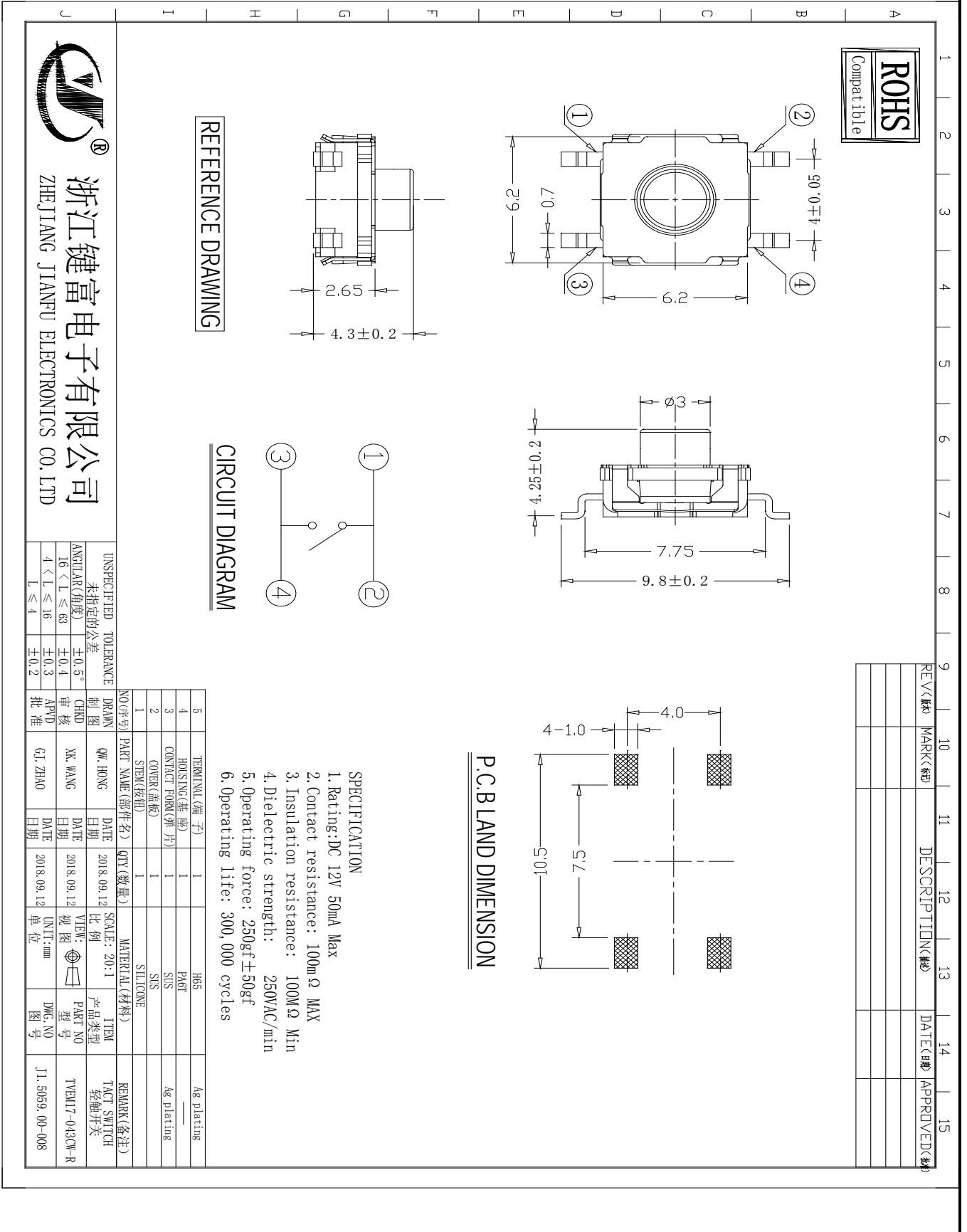

规格承认书

规格书编号

J.SPC.50.59-008

品名

6.2X6.2X4.3 IP67

型号

TVEM17-043CW-R

3/10

4.3 构造:

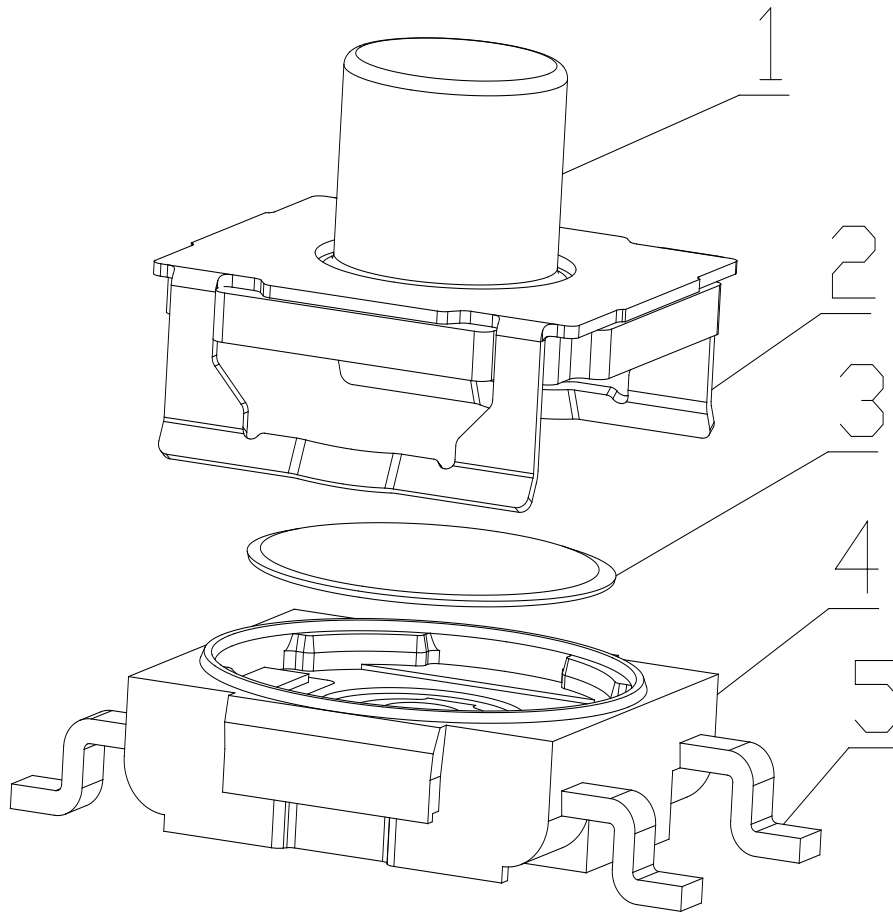

序号	零部件名称	数量	材料名称	表面处理	备注
1	STEM	1	硅胶		
2	COVER	1	SUS		
3	CONTACT	1	SUS	Ag plating	
4	BASE	1	PA6T		
5	TERMINAL	1	黄铜	Ag plating	
6					
7					

规格承认书

规格书编号
J.SPC.50.59-008

品名

6.2X6.2X4.3 IP67

型号

TVEM17-043CW-R

4/10

6. General Specification 性能

6.1 电气的性能

Item 项目	Test Condition 测试条件	Requirements 要求
6.1.1	<p>Applying static load twice the actuating force to the center of the stem, measurements shall be made with a 1 kHz small-current contact resistance meter. 用两倍的动作用力作静负载施加于按钮的中心,并用 1 千赫小电流接触电阻仪测量</p>	100mΩ 以下
6.1.2	<p>Measurements shall be made following application of DC100V potential between terminals and between individual terminals and frame for one minute.在端子与端子之间,端子与外壳之间施加DC100V,一分钟</p>	100MΩ 以上
6.1.3	<p>AC 250 V (50Hz or60Hz) shall be applied between terminals and between individual terminals and frame for one minute. 在端子与端子之间,端子与外壳之间施加AC250V(50HZ-60HZ)</p>	There shall be no breakdown. 无击穿、闪烁现象
6.1.4	<p>Lightly striking the center of the stem at a rate encountered in normal use (3 to 4 operations per sec), Bounce shall be tested when “ON” and “OFF”. 在正常使用中(以每秒 3-4 次周期)轻轻地在手柄中心加力,在通与断瞬间测试抖动</p> <div style="text-align: center;"> </div> <p style="text-align: center;">t 为触点抖动时间</p>	5mS 以下

规格承认书

规格书编号
J.SPC.50.59-008

品名

6.2X6.2X4.3 IP67

型号

TVEM17-043CW-R

5/10

6.2 机械的性能

Item 项目		Test Condition 测试条件	Requirements 要求
6.2.1	Operating Force 动作力	Place the switch such that the direction of switch operation is vertical and then gradually increase the load applied to the center of the stem, the maximum load required for the stem to come to a stop shall be measured. 开关的动作方向为垂直放置开关向推柄中心逐渐地增加负荷直到推柄停止时所测量的最大负荷	<u>250 ± 50gf</u>
6.2.2	Travel 行程	Place the switch such that the direction of switch operation is vertical and then apply a static load twice the actuating force to the center of the stem, the travel distance for the stem to come to a stop shall be measured. 开关的动作方向为垂直放置开关,并以双倍动作力的静负荷作用推柄中心,测量推柄从开始到停止的行程距离	<u>0.50 ± 0.30 mm</u>
6.2.3	Return Force 返回力	The sample switch is installed such that the direction of switch operation is vertical and, upon depression of the stem in its center the whole travel distance, the force of the stem to return to its free position shall be measured. 开关的动作方向为垂直放置开关,在已有行程的推柄中心向上减小压力,推柄回到自由位置时所测量到的力	<u>30gf min</u>
6.2.4	Static Strength 静止强度	Placing the switch such that the direction of switch operation is vertical, a static load of <u>49 N</u> shall be applied in the direction of stem operation for a period of <u>15</u> seconds. 开关的动作方向为垂直放置开关,在推柄动作方向施加 49N 的静负荷, 15 秒时间	There shall be no sign of damage mechanically and electrically. 无机械的和电气的损伤迹象

规格承认书

规格书编号
J.SPC.50.59-008

品名	6.2X6.2X4.3 IP67	型号	TVEM17-043CW-R	6/10
----	------------------	----	----------------	------

6.3 使用耐久性能

Item 项目	Test Condition 测试条件	Requirements 要求
6.3.1 Operating Life 动作寿命	Measurements shall be made following the test set forth below:按下列条件进行寿命试验 (1)DC 12V 50mA resistive load. DC 12V 50mA 阻性负载 (2)Rate of operation:2 to 3 operations per second 动作频率: 2-3 次/每秒 (3)Depression: <u>375</u> gf减压力 (4)Cycles of operation: 30×10^4 cycles 动作次数: 30×10^4 次	Contact resistance: <u>500</u> mΩ Max. 接触电阻 Insulation resistance: <u>50</u> MΩ Min. 绝缘电阻 Actuating force: 动作力 + <u>30</u> %or- <u>30%</u> of initial force. ±30%初始动作力 Item 6.1.3 Item 6. 2.2
6.3.2 Moisture Resistance 耐潮湿	Following the test set forth below the sample shall be left in normal temperature and humidity conditions for one hour before measurements are made: 样品按下列条件进行耐潮湿试验,试验后在正常温度和湿度条件下放置 1 小时后测定 (1) Temperature: $60 \pm 2^\circ\text{C}$ 温度 (2) Relative humidity: 90 to 95% 相对湿度 (3) Time: 96 hours 时间 Water drops shall be removed. 擦除水珠	Contact resistance: <u>200</u> mΩ Max. 接触电阻 Insulation resistance : <u>50</u> MΩ Min. 绝缘电阻 Item 6.1.3、6.1.4 Item 6. 2.1~6.2.3
6.3.3 Low Temperature Resistance 耐低温	Following the test set forth below the sample shall be left in normal temperature and humidity conditions for one hour before measurements are made: 样品按下列条件进行耐低温试验,试验后在正常温度和湿度条件下放置 1 小时后测定 (1)Temperature: $-40 \pm 2^\circ\text{C}$ 温度 (2) Time: 96 hours 时间 Water drops shall be removed. 擦除水珠	Contact resistance: <u>200</u> mΩ Max. 接触电阻 Insulation resistance : <u>50</u> MΩ Min. 绝缘电阻 Item 6.1.3、6.1.4 Item 6. 2.1~6.2.3
6.3.4 Heat Resistance 耐热	Following the test set forth below the sample shall be left in normal temperature and humidity conditions for one hour before measurements are made: 样品按下列条件进行耐热试验,试验后在正常温度和湿度条件下放置 1 小时后测定 (1)Temperature: $90 \pm 2^\circ\text{C}$ 温度 (2) Time: 96 hours 时间	Contact resistance: <u>200</u> mΩ Max. 接触电阻 Insulation resistance : <u>50</u> MΩ Min. 绝缘电阻 Item 6.1.3、6.1.4 Item 6. 2.1~6.2.3
6.3.5	IP67 1m 浸渍 30 分钟	产品内部不能进水,功能正常

规格承认书

规格书编号
J.SPC.50.59-008

品名	6.2X6.2X4.3 IP67	型号	TVEM17-043CW-R	7/10
----	------------------	----	----------------	------

Item 项目	Test Condition 测试条件	Requirements 要求
6.3.6 Change of Temperature 温度循环	<p>Following ten cycles of high temperature test .The Sample shall be Placed in Normal temperature and humidity Conditions for one hour before measurements are made. During this test, water drops shall be removed. 样品按下列条件进行高低温循环试验,试验后在正常温度和湿度条件下放置 1 小时后测定</p> <div style="display: flex; align-items: center;"> <div style="margin-right: 20px;"> <p>温度(°C)</p> <p style="text-align: center;">时间(hour)</p> </div> <div> <p>A: +90°C B: -40°C C: 2 小时 D: 1 小时 E: 2 小时 F: 1 小时</p> </div> </div> <p style="text-align: center;">Cycling: 5 cycles 周期: 5 次</p>	<p>Contact resistance: <u>200</u> mΩ Max. 接触电阻</p> <p>Insulation resistance : <u>50</u> MΩ Min. 绝缘电阻</p> <p>Item 6.1.3、6.1.4 Item 6. 2.1~6.2.3</p>
6.3.7 Vibration Resistance 耐振动	<p>Measurements shall be made following the test set forth below: 按下列条件进行抗振动试验</p> <p>(1)Range of oscillation: 10 to 55Hz 频率范围 (2)Amplitude,pk-to-pk:1.5mm 振幅: 峰-峰 1.5mm (3)Cycle of sweep: 10-55-10Hz in one minute, approx.扫描周期: 10-55-10Hz 约一分钟内 (4)Mode of sweep: Logarithmically sweep or uniform sweep. 扫描方式: 对数扫描式恒定扫描 (5)Direction of oscillation: 振动方向 Three mutually perpendicular directions, including the direction of stem travel. 3 个相互垂直方向,包括推柄行程方向 (6)2 hours each ,for a total of 6hours.每方向 2 小时.共 6 小时</p>	<p>Item 6.1 Item 6. 2.1、6.2.2</p>

规格承认书

规格书编号
J.SPC.50.59-008

品名

6.2X6.2X4.3 IP67

型号

TVEM17-043CW-R

8/10

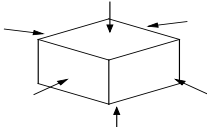
Item 项目	Test Condition 测试条件	Requirements 要求
6.3.8 Impact Shock Resistance 抗冲击	Measurements shall be made following the test set forth below: 按下列条件进行冲击试验 (1)Acceleration: 98m/S ² 加速度 (2)Cycles of test : 3 cycles each in 6directions, for a total of 18cycles 试验次数:每个方向3次,6个方向共18次 <div style="text-align: center;">  </div>	Item 6.1 Item 6. 2.1、6.2.2

7. 焊接条件:

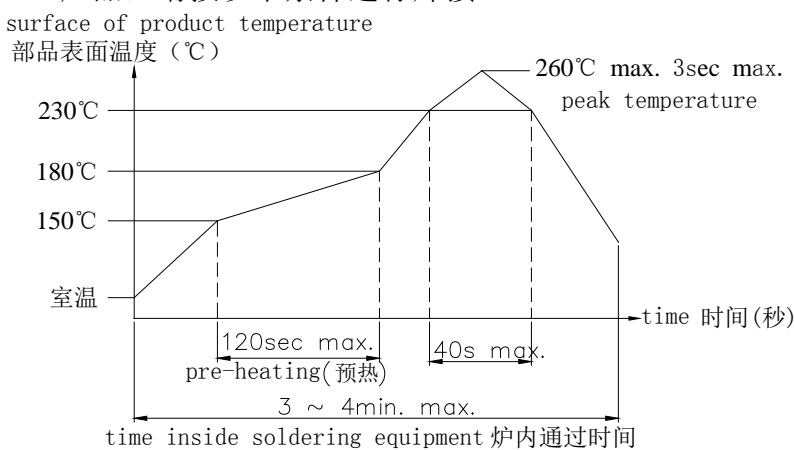
Item 项目	Recommended conditions 推荐条件
7.1 Hand Soldering 手工焊接	Please practice according to bellow conditions: (1)Soldering temperature : ≤350℃ (2)Continuous soldering time: ≤3S (3)Capacity of soldering iron: ≤60 W 请按以下条件进行焊接: (1)焊锡温度: ≤350℃ (2)连续焊接时间: ≤3 S (3)电烙铁的功率: ≤60 W
7.2 Automatic Flow Soldering 自动焊接	For the product of SMT ,type solder according to the following conditions 对于 SMT 产品, 请按以下条件进行焊接 <div style="text-align: center;">  </div> <p>time inside soldering equipment 炉内通过时间</p> <p>Caution: the condition mentioned above is a temperature on the PWB surface on which parts are mounted. There are cases where PWB temperature greatly differs from switch's surface temperature depending on PWB material, size, thickness, etc. The switch's surface temperature shall not allowed to exceed 260℃ 注意: 以上提及的条件是零部件上 PWB 表面的温度, 由于 PWB 的材料、尺寸、厚度等不同, PWB 从开关表面获得的温度也会有很大产不同, 因此, 千万小心不要让开关表面温度超过 260℃</p>

规格承认书				规格书编号 J.SPC.50.59-008
品名	6.2X6.2X4.3 IP67	型号	TVEM17-043CW-R	9/10

8. Other Precautions 其他注意事项:

- (1) Following the soldering process, do not try to clean the switch with a solvent or the like.
进行焊接过程中，不可以用溶剂或类似品清洗开关
- (2) Safeguard the switch assembly against flux penetration from its topside.
防止助焊剂从开关的顶端渗入
- (3) Please have the products keep in close status and the storage time is 90 days guaranty after delivering the goods at most.
交货后保证开关处于封密状态并库存时间 90 天以下

9.Reel Packaging 盘装

9.1 Scope 范围

This specification covers the requirements of the reel packaging for SMT standard type of tact switches. 该规范包含 SMT 标准型贴片开关的绕带封装的要求

9.2 Packaging Materials 封装材料

Item	项目	Description	说明
Package	包装	Cartons	卡通箱
Reel	转轴	Delete Cartons	可降解箱
Carrier Tape	载带	Polypropylene	聚丙烯

9.3 Packaging Quantity 封装数量

9.3.1 The number of the reels. 转轴数量

Twenty (20) reels at maximum. Which contain 20K pcs switches
Shall be packed in a package. 一箱装 20 盘,有 20K 只产品

9.3.2 The number of the switches. 产品数量

1K pcs switches shall be packed in a reel. 一个转轴包 1K 只产品

9.3.3 It should be noted that we regard two cartons 对出口包装需注意用两个箱子包装
mentioned above as on package for export.

* THE DIMENSION OF CARRIER TAPE, COVER TAPE AND REEL *

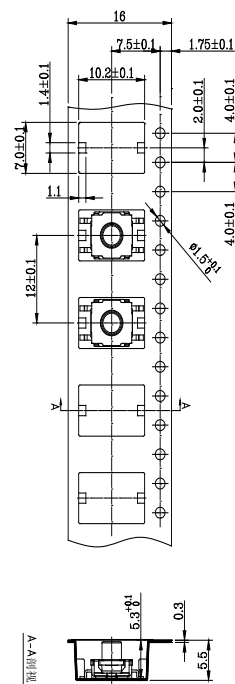

MODEL NAME	CODE NO.
TWEM17	

* THE SPECIFICATION FOR PACKAGING *

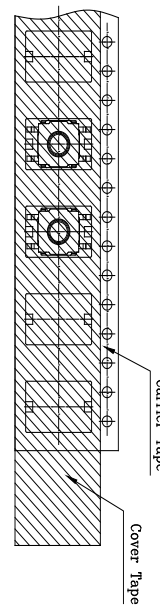

DRAWING DIRECTION

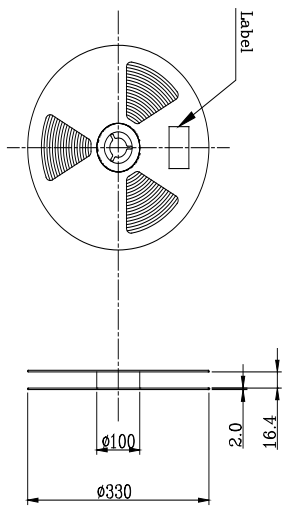

End

* THE SPECIFICATION FOR PACKAGING *

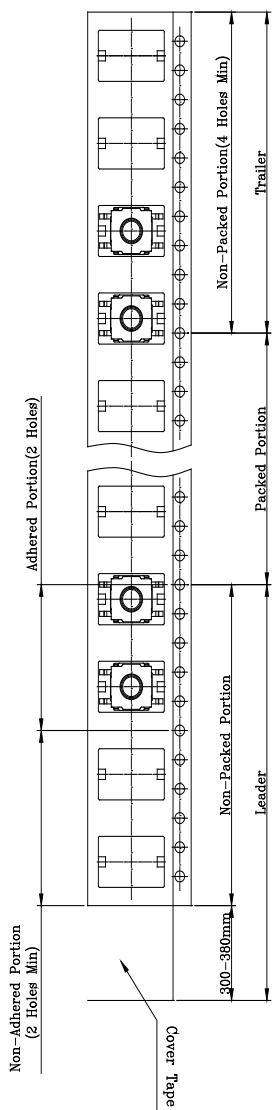

* END TAPE *

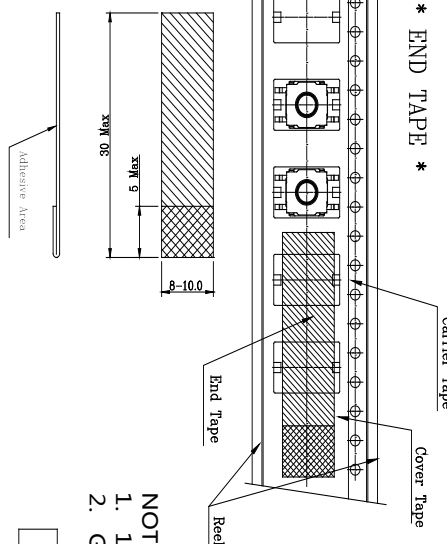

- NOTE
1. 1k pcs SWITCHES PER 1 REEL
 2. GENERAL TOLERANCE : 0.2mm

REFERENCE DRAWING

RevNo	Revision note	Date	Signature

Designed by	<p>ZHEJIANG JIANFU ELECTRONICS CO., LTD</p>			
Checked by				
Approved by				
Unit				
Team	TACTILE SWITCH	mm	N/S	Date
Model	6.2X6.2 SMT	Scale	Sheet	1/1
Tool	A-Cad	Date	Rev.	1
Drawing name	ASSEMBLY			