

安规陶瓷电容器产品承认书

APPROVAL SPECIFICATIONS FOR SAFETY CERAMIC CAPACITOR

客户 CUSTOMER			
客户料号 CUSTOMER P/N			
规格描述 DESCRIPTION	WD Y1 332M 500VAC Y5V F10		
产品编码 PART NUMBER	WYD2H332MF4S620000		
日期 DATE	2023-05-04	文件编号 DOC. NO.	WD-SPEC-002A

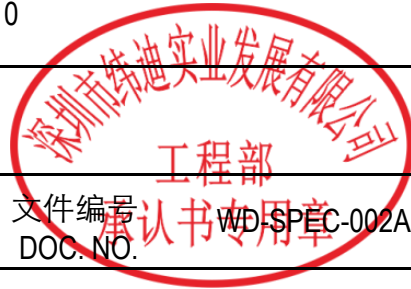

纬迪承认栏 APPROVED BY WEIDY		客户承认栏 APPROVED BY CUSTOMER	
批 准 Approved by	制 订 Formulate by	批 准 Approved by	审 核 Check by
赵光涛	钟茂源		

深圳市纬迪实业发展有限公司

SHENZHEN WEIDY INDUSTRIAL DEVELOPMENT CO.,LTD

公司地址：深圳市振中路（华强北）新亚洲电子商城五楼506-509室

工厂地址：东莞市塘厦镇平山松荫路3号

东莞市塘厦镇石鼓岭南大道106号

TEL: +86-755-82811688 FAX: +86-755-82812688

Website: <http://www.szweidy.com>

安规陶瓷电容器产品规格书

PRODUCT SPECIFICATIONS FOR SAFETY CEAMIC CAPACITOR

目录

CONTENTS

1. 承认产品规格表 APPROVE PRODUCT SPECIFICATION SHEET	2
2. 概述 INTRODUCTION	3
3. 通用特性 GENERAL SPECIFICATIONS	4
4. 型号命名方式 PART NUMBER	6
5. 标准与试验方法 SPECIFICATIONS AND TESTING METHOD	8
6. 测量和使用注意事项 MEASURING AND APPLICATION NOTICE	11
6.1. 测量 MEASUREMENT	11
6.2. 工作电压 OPERATING VOLTAGE	12
6.3. 工作温度与自生热 OPERATING TEMPERATURE AND SELF-GENERATED HEAT	12
6.4. 耐电压的测试条件 TEST CONDITION FOR WITHSTANDING VOLTAGE	13
6.5. 失效安全性 FAIL-SAFE	13
6.6. 电容器容量变化 CAPACITANCE CHANGE OF CAPACITORS	14
6.7. 使用设备检查 PERFORMANCE CHECK BY EQUIPMENT	14
6.8. 贮存与使用条件 OPERATING AND STORAGE ENVIRONMENT	14
6.9. 焊锡和安装 SOLDERING AND MOUNTING	

安规陶瓷电容器产品规格书

PRODUCT SPECIFICATIONS FOR SAFETY CERAMIC CAPACITOR

2. 概述

INTRODUCTION

2.1. 范围

SCOPE

本规格书适用于通过cUL、VDE、ENEC和CQC认证的安规陶瓷电容器。

THIS SPECIFICATION APPLIES TO THE CUL, VDE, ENEC AND CQC APPROVED SAFETY RECOGNIZED CERAMIC CAPACITORS.

2.2. 应用

APPLICATIONS

X/Y电容器可使用在开关电源与AC适配器的滤波电路和耦合电路。

IDEAL FOR USE AS X/Y CAPACITORS FOR AC LINE FILTER AND PRIMARY-SECONDARY COUPLING ON SWITCHING POWER SUPPLIES AND AC ADAPTERS.

也可使用在没有变压器的DAA模块的D-A隔离和吸收杂音上。

IDEAL FOR USE ON D-A ISOLATION AND NOISE ABSORPTION FOR DAA MODEMS WITHOUT TRANSFORMERS.

2.3. 特点

FEATURES

- 操作温度高达125°C

OPERATING TEMPERATURE RANGE GUARANTEED UP TO 125 DEGREES

- 通过cUL、VDE、ENEC、CQC和KC认证，符合IEC 60384-14要求

BY cUL, VDE, ENEC, CQC AND KC CERTIFIED TO COMPLY WITH IEC 60384-14 REQUIREMENTS

认证标志 APPROVAL MARK	认证标准 APPROVAL STANDARDS	额定电压 RATED VOLTAGE	认证证书号 CERTIFICATE NUMBER
	UL 60384-14	X1:AC500V Y1:AC250/300/400/500V X1:AC400V Y2:AC125/250/300V	E334332
	DIN EN 60384-14 (VDE0565-1-1):2014-04; EN 60384-14:2013-08 DIN EN 60384-14/A1 (VDE 0565-1-1/A1):2017-04; EN 60384-14:2013/A1:2016 IEC 60384-14:2013 IEC 60384-14:2013/AMD1:2016		X1/Y1: 40051104 X1/Y2: 40051013
	GB/T6346.14-2015		X1/Y1: CQC20001237500 X1/Y2: CQC20001237499
	KC60384-1(2015-09) KC60384-14(2015-09)		Y1:AC 250 V Y2:AC 250 V

- 使用阻燃的环氧树脂包封（符合UL94 V-0标准）

COATED WITH FLAME-RETARDANT EPOXY RESIN (CONFORMING TO UL94 V-0 STANDARD)

- 结构如下图所示

THE STRUCTURE IS SHOWN BELOW

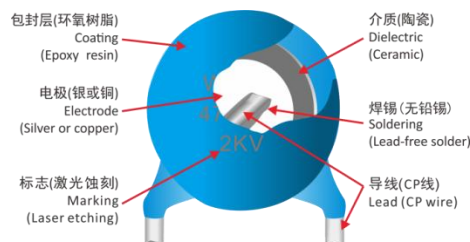

- 可适用于自动化生产线

COST-SAVING AUTOMATIC INSERTION AVAILABLE

- 符合RoHS 2.0标准。

COMPLY WITH RoHS 2.0

安规陶瓷电容器产品规格书 PRODUCT SPECIFICATIONS FOR SAFETY CEAMIC CAPACITOR

编号DOC NO.:	WD-SPEC-002A
版本REV.:	A/1
日期DATE:	2018-4-1
页码PAGE:	4 / 15

3. 通用特性 GENERAL SPECIFICATIONS

类别 SUBCLASS	X1 / Y1 (WYD)	X1 / Y2 (WYE)
电容量范围 CAPACITANCE RANGE	10PF ~ 0.0047UF	100PF ~ 0.01UF
额定电压 RATED VOLTAGE	X1: AC500V / Y1: AC250/300/400/500V	X1: AC400V / Y2: AC125/250/300V
耐电压 TEST VOLTAGE (TV)	使用4000VAC(50HZ-60HZ, 电流小于50MA)测量1分钟, 无异常 THE CAPACITOR SHOULD NOT BE DAMAGED WHEN 4000VAC (50HZ-60HZ, 50MA MAX.) FOR 1 MINUTE.	使用2600VAC(50HZ-60HZ, 电流小于50MA)测量1分钟, 无异常 THE CAPACITOR SHOULD NOT BE DAMAGED WHEN 2600VAC (50HZ-60HZ, 50MA MAX.) FOR 1 MINUTE.
电容量 CAPACITANCE (C _R)	在25°C环境下使用1KHZ 1.0VRMS (SL使用1MHZ或100KHZ) 的条件进行测量, 容量在允许误差范围内。 WITHIN THE SPECIFIED TOLERANCE. Y5P, Y5U, Y5V MEASURED AT 1KHZ±20%, SL MEASURED AT 1MHZ (100KHZ) ±20%, BOTH ARE 1VRMS, 25°C	
损耗角正切 TANGENT OF LOSS ANGLE (TANδ)	Y5P, Y5U, Y5V: TANδ≤0.025 测量条件同“电容量” MEASURED CONDITION SEE “CAPACITANCE”	
绝缘电阻 INSULATION RESISTANCE (IR)	使用500VDC测量1分钟, 绝缘电阻不小于10 000 MΩ 10 000MΩ MINIMUM AT 500VDC FOR 1 MINUTE.	
温度特性 TEMPERATURE CHARACTERISTIC (TC)	Y5P, Y5U, Y5V	
气候类别 CLIMATIC CATEGORY	40/125/21	
阻燃等级 PASSIVE FLAMMABILITY CATEGORY	C	

■ Y电容分类 CLASS Y CAPACITORS CLASSIFICATION

类别 SUBCLASS	跨接的绝缘类型 INSULATION BRIDGED TYPE	额定电压 RATED VOLTAGES	试验电压 VOLTAGE PROOF	峰值脉冲电压 PEAK IMPULSE VOLTAGE, U _p (1.2/50μS)
Y1	双重绝缘或增强绝缘 DOUBLE INSULATION OR REINFORCED INSULATION	≤500VAC	4KVAC	U _p = 8.0 KV
Y2	基本绝缘或辅助绝缘 BASIC INSULATION OR SUPPLEMENTARY INSULATION	≥150VAC ≤500VAC	U _R + 1.2KVAC WITH A MINIMUM OF 1.5VAC	U _p = 5.0 KV
Y4	基本绝缘或辅助绝缘 BASIC INSULATION OR SUPPLEMENTARY INSULATION	<150VAC	900VAC	U _p = 2.5 KV

- 本表数据来源IEC 60384-14-2013表2与表10
THIS TABLE DATA SOURCES IEC 60384-14-2013 TABLE 2 AND TABLE 10
- Y3电容器在IEC 60384-14-2013版时被删除
Y3 CAPACITORS ARE DELETED IN IEC 60384-14-2013
- Y2电容器可以由相同或更高额定电压的Y1电容器代替
Y2 CAPACITORS MAY BE SUBSTITUTED BY Y1 CAPACITORS OF THE SAME OR HIGHER RATED VOLTAGE
- 双重绝缘、增强绝缘、基本绝缘与辅助绝缘的定义见IEC 61140
FOR DEFINITIONS OF BASIC, SUPPLEMENTARY, DOUBLE AND REINFORCED INSULATION, SEE IEC 61140
- 与额定脉冲电压和电源电压相关的过电压类别见IEC 60664-1
OVERVOLTAGE CATEGORIES IN ASSOCIATION WITH RATED IMPULSE VOLTAGE AND RATED MAINS VOLTAGE ARE FOUND IN IEC 60664-1
- 在Y2和Y4电容器的逐批检验中, AC测试电压可以使用1.5倍的DC电压代替
FOR LOT-BY-LOT TESTS OF CLASS Y2- AND Y4-CAPACITORS, THE A.C. TEST VOLTAGE MAY BE REPLACED BY A D.C. VOLTAGE OF 1,5 TIMES THE PRESCRIBED A.C. VOLTAGE.

安规陶瓷电容器产品规格书

PRODUCT SPECIFICATIONS FOR SAFETY CERAMIC CAPACITOR

温度特性典型曲线图 (仅供参考)

TYPICAL TEMPERATURE CHARACTERISTIC CURVES (FOR REFERENCE)

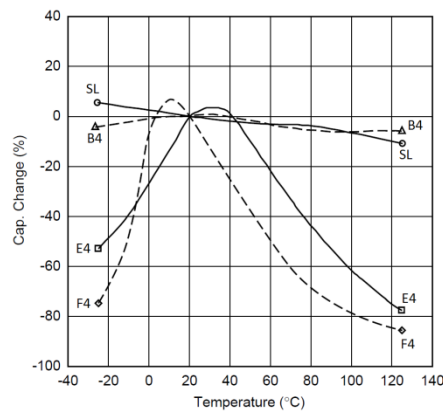

插入损耗与频率特性

INSERTION LOSS-FREQUENCY CHARACTERISTICS

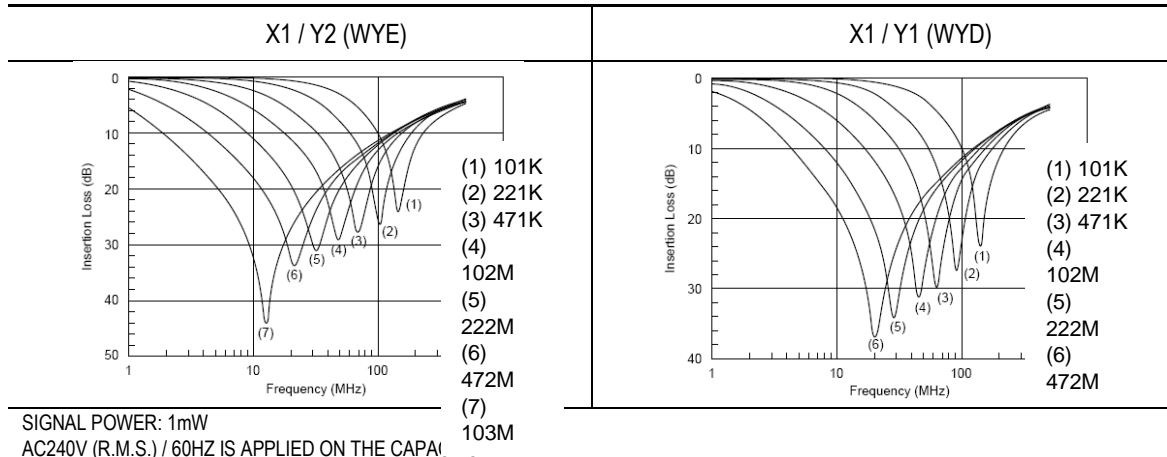

漏电流特性

LEAKAGE CURRENT CHARACTERISTICS

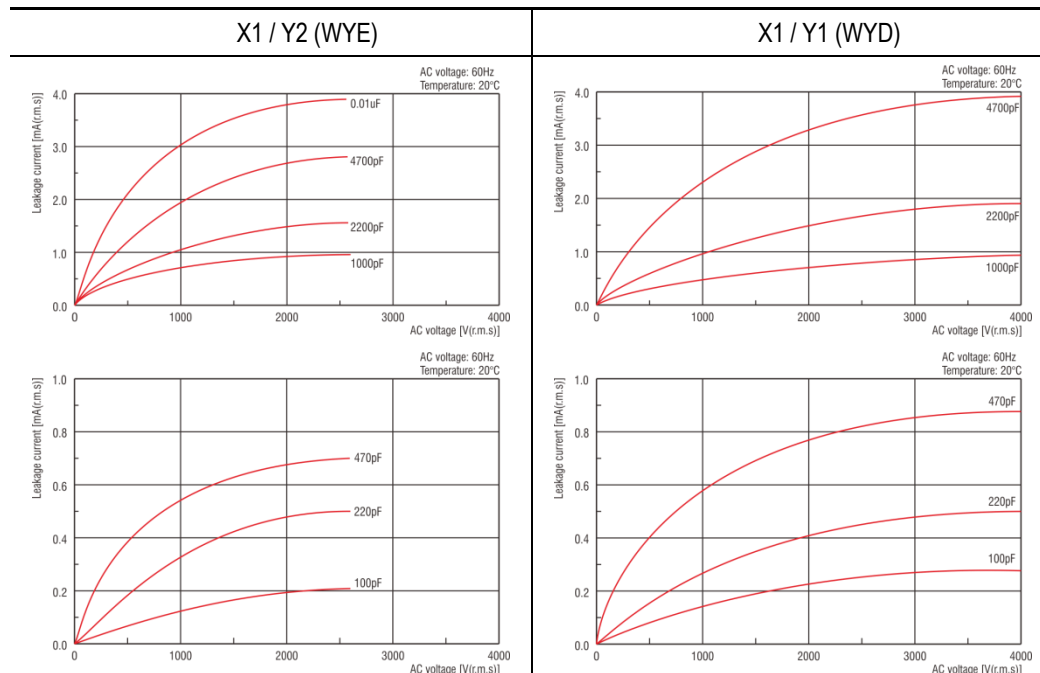

安规陶瓷电容器产品规格书

PRODUCT SPECIFICATIONS FOR SAFETY CEAMIC CAPACITOR

4. 型号命名方式 (仅供参考) PART NUMBER(FOR REFERENCE)

WYD **2H** **102** **M** **F4** **S** **6** **20** **000**
① **②** **③** **④** **⑤** **⑥** **⑦** **⑧** **⑨**

① 产品类别

PRODUCT TYPE

WYD: X1 / Y1

WYE: X1 / Y2

② 额定电压 (特指Y电容的额定电压)

RATED VOLTAGE (Y CAPACITOR)

2E: 250VAC

2F: 300VAC

2G: 400VAC

2H: 500VAC

③ 标称容量

NOMINAL CAPACITANCE

标称容量用三位数表示, 单位为PF, 第一、二位为有效数字, 第三位为前两位后面跟“0”的个数; 当有小数点时, 小数点用“R”表示。

NOMINAL CAPACITANCE IS EXPRESSED IN 3-DIGIT NUMBER, IN PICO-FARADS; THE FIRST TWO DIGITS INDICATE SIGNIFICANT DIGITS. THE 3RD DIGIT INDICATES THE NUMBER OF ZERO FOLLOWING. R DENOTES DECIMAL.

代码 CODE	0R5	010	100	102	222	103	104
标称容量 NOMINAL CAPACITANCE	0.5PF	1PF	10PF	1000PF 1NF	2200PF 2.2NF	10000PF 10NF 0.01UF	100000PF 100NF 0.1UF

④ 容量误差

CAPACITANCE TOLERANCE

J: ±5% (FOR PRODUCTS UNDER 100PF)

K: ±10% (FOR PRODUCTS UNDER 1000PF)

M: ±20%

⑤ 温度特性

TEMPERATURE CHARACTERISTICS



B4: Y5P

E4: Y5U

F4: Y5V

⑥ 脚型

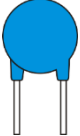
LEAD STYLE

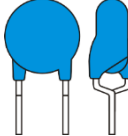
CODE	S	K	I	V
脚型 LEAD STYLE	直脚 STRAIGHT LEAD	外弯脚 OUTSIDE KINK LEAD	内弯脚 INSIDE KINK LEAD	平行脚 VERTICAL KINK LEAD
脚型示意图 LEAD STYLE DRAWING				

⑦ 脚距

LEAD SPACING

CODE	3	4	5	6	7
脚距 LEAD SPACING	5.0MM	6.4MM	7.5MM	10.0MM	12.5MM

⑧ 脚长或编带规格

Lead length or taping specifications

CODE	03	3B	3H	05	10	20	25
脚长 LEAD LENGTH	3.0MM	3.2MM	3.8MM	5.0MM	10MM	20MM	25MM

⑨ 内部码

INNER CODE

内部控制码, 本目录不作说明。

INTERNAL CONTROL CODE WILL NOT BE DESCRIBED IN THIS CATALOG

5. 标准与试验方法

SPECIFICATIONS AND TESTING METHOD

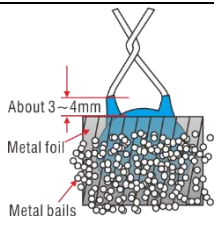
序 NO.	项目 ITEM	标准 SPECIFICATIONS	试验方法 TESTING METHOD											
1	外观与尺寸 APPEARANCE (APP) AND DIMENSION	外观形状没有明显的缺点, 尺寸在标准范围内。 NO MARKED DEFECT ON APPEARANCE FORM AND DIMENSIONS ARE WITHIN SPECIFIED RANGE.	电容必须用目视检查其明显的缺点。 THE CAPACITOR SHOULD BE VISUALLY INSPECTED FOR EVIDENCE OF DEFECT. 尺寸用游标卡尺测量。 DIMENSIONS SHOULD BE MEASURED WITH SLIDE CALIPERS.											
2	标志 MARKING	清晰易于识别 TO BE EASILY LEGIBLE	目视检查。 THE CAPACITOR SHOULD BE VISUALLY INSPECTED.											
3	容量 CAPACITANCE (C _R)	在误差范围内 WITHIN SPECIFIED TOLERANCE	容量与损耗在25±1°C下, 使用1KHZ(SL使用1MHZ或100KHZ)和1VRMS下测量。 THE CAPACITANCE, TANδ (Q VALUE) SHOULD BE MEASURED AT 25°C ± 1°C WITH 1KHZ (SL: 1MHZ OR 100KHZ) AND AC1.0V (R.M.S.).											
4	损耗角正切 TANGENT OF LOSS ANGLE (TANδ)	Y5P, Y5U, Y5V: <0.025	测量前阅读7.1项 READ 7.1 BEFORE MEASUREMENT											
5	绝缘电阻 INSULATION RESISTANCE (IR)	>10 000MΩ	在两导线间施加500VDC进行测量, 时间不超过1分钟(如果绝缘电阻达到要求值时, 试验可以在更短的时间内结束)。 THE INSULATION RESISTANCE SHOULD BE MEASURED WITH A DC 500V AT NORMAL TEMPERATURE AND HUMIDITY AND LESS THAN 1 MIN. OF CHARGING (THE TEST MAY BE TERMINATED IN A SHORTER TIME, IF THE REQUIRED VALUE OF INSULATION RESISTANCE IS REACHED).											
6	导线间 BETWEEN LEAD WIRES	无失效。 NO FAILURE	在电容器两导线间施加下表测试电压60S后不被破坏(充/放电流不大于50MA)。 THE CAPACITOR SHOULD NOT BE DAMAGED WHEN TEST VOLTAGES OF FOLLOWING TABLE ARE APPLIED BETWEEN THE LEAD WIRES FOR 60 SEC. (CHARGE/DISCHARGE CURRENT ≤50MA)											
	耐电压 TEST VOLTAGE (TV)	本体绝缘 BODY INSULATION	<table border="1"> <thead> <tr> <th>类型 TYPE</th> <th>WYE</th> <th>WYD</th> </tr> </thead> <tbody> <tr> <td>耐电压 VOLTAGE PROOF</td> <td>AC2600V</td> <td>AC4000V</td> </tr> </tbody> </table> <p>首先, 将电容器的端子拧在一起, 然后如右图所示, 将金属箔包住电容器离端子3MM-4MM的本体, 接着将电容器插入盛着直径为1MM的金属球的容器中, 最后施加如下表所示的AC电压60秒钟。 FIRST, THE TERMINALS OF THE CAPACITOR SHOULD BE CONNECTED TOGETHER. THEN, AS SHOWN IN FIGURE AT RIGHT, A METAL FOIL SHOULD BE CLOSELY WRAPPED AROUND THE BODY OF THE CAPACITOR TO THE DISTANCE OF ABOUT 3 TO 4MM FROM EACH TERMINAL. THEN, THE CAPACITOR SHOULD BE INSERTED INTO A CONTAINER FILLED WITH METAL BALLS OF ABOUT 1MM DIAMETER. FINALLY, AC VOLTAGE OF FOLLOWING TABLE IS APPLIED FOR 60 SEC. BETWEEN THE CAPACITOR LEAD WIRES AND METAL BALLS.</p> <table border="1"> <thead> <tr> <th>类型 TYPE</th> <th>WYE</th> <th>WYD</th> </tr> </thead> <tbody> <tr> <td>耐电压 VOLTAGE PROOF</td> <td>AC2600V</td> <td>AC4000V</td> </tr> </tbody> </table> 	类型 TYPE	WYE	WYD	耐电压 VOLTAGE PROOF	AC2600V	AC4000V	类型 TYPE	WYE	WYD	耐电压 VOLTAGE PROOF	AC2600V
类型 TYPE	WYE	WYD												
耐电压 VOLTAGE PROOF	AC2600V	AC4000V												
类型 TYPE	WYE	WYD												
耐电压 VOLTAGE PROOF	AC2600V	AC4000V												
7	导线抗张强度 TERMINAL TENSILE STRENGTH	导线无折断, 电容无破损。 LEAD WIRE SHOULD NOT BE CUT OFF. CAPACITOR SHOULD NOT BE BROKEN.	如右图所示, 固定电容器的本体, 使电容器每支导线均承受10N垂直力, 保持10±1秒钟。 AS SHOWN IN THE FIGURE AT RIGHT, FIX THE BODY OF THE CAPACITOR AND APPLY A TENSILE WEIGHT GRADUALLY TO EACH LEAD WIRE IN THE RADIAL DIRECTION OF THE CAPACITOR UP TO 10N AND KEEP IT FOR 10±1 SEC.											
8	导线抗折强度 TERMINAL BENDING STRENGTH	导线无折断, 电容无破损。 LEAD WIRE SHOULD NOT BE CUT OFF. CAPACITOR SHOULD NOT BE BROKEN.	电容器导线应承受5N重量, 然后向外弯折成90°, 然后回复到原来位置; 接着往反方向弯折90°, 再复原; 弯折一次2-3秒钟。 EACH LEAD WIRE SHOULD BE SUBJECTED TO 5N WEIGHT AND THEN A 90° BEND, AT THE POINT OF EGRESS, IN ONE DIRECTION, RETURN TO ORIGINAL POSITION, AND THEN APPLY A 90° BEND IN THE OPPOSITE DIRECTION AT THE RATE OF ONE BEND IN 2 TO 3 SEC.											
9	振动 VIBRATION RESISTANCE	APP	没有可见损伤 NO MARKED DEFECT											
		C _R	在允许误差范围内 WITHIN THE SPECIFIED TOLERANCE											
		TANδ	如第4项 PER ITEM 4											
		将电容器导线焊稳和调整振动频率范围为10-55HZ、总振幅为1.5MM, 振动从10HZ到55HZ, 然后再回到10HZ, 大约一分钟。 THE CAPACITOR SHOULD BE FIRMLY SOLDERED TO THE SUPPORTING LEAD WIRE AND VIBRATED AT A FREQUENCY RANGE OF 10 TO 55HZ, 1.5MM IN TOTAL AMPLITUDE, WITH ABOUT A 1 MINUTE RATE OF VIBRATION CHANGE FROM 10HZ TO 55HZ AND BACK TO 10HZ. 总时间六个小时, 每两小时在相互垂直方向来回三次。 APPLY FOR A TOTAL OF 6 HRS., 2 HRS EACH IN 3 MUTUALLY PERPENDICULAR DIRECTIONS.												

☐ 接上页

CONTINUED FROM THE PRECEDING PAGE

序 NO.	项目 ITEM	标准 SPECIFICATIONS	试验方法 TESTING METHOD			
10	可焊性 SOLDERABILITY OF LEADS	导线必须有3/4以上的面积均匀附着焊锡。 LEAD WIRE SHOULD BE SOLDERED WITH UNIFORM COATING ON THE AXIAL DIRECTION OVER 3/4 OF THE CIRCUMFERENTIAL DIRECTION.	将电容器的导线浸入焊料中2±0.5秒钟，浸入深度离导线根部1.5-2.0MM。 THE LEAD WIRE OF A CAPACITOR SHOULD BE DIPPED INTO MOLTEN SOLDER FOR 2±0.5 SEC. THE DEPTH OF IMMERSION IS UP TO ABOUT 1.5 TO 2.0MM FROM THE ROOT OF LEAD WIRES. 焊锡温度： 无铅焊锡 (SN-3AG-0.5CU) 245±5°C TEMP. OF SOLDER: LEAD FREE SOLDER (SN-3AG-0.5CU) 245±5°C 易溶解的H63号锡 (PB37/SN63) 235±5°C H63 EUTECTIC SOLDER (PB37/SN63) 235±5°C			
11	耐焊接热 SOLDERING EFFECT	APP	如图所示，导线浸入离根部1.5-2.0MM处、锡温为260±5°C锡槽中10±1秒。 AS SHOWN IN FIGURE, THE LEAD WIRES SHOULD BE IMMERSSED IN SOLDER OF 260±5°C UP TO 1.5 TO 2.0MM FROM THE ROOT OF TERMINAL FOR 10±1.0 SEC. 预处理PRE-TREATMENT: 电容器必须先贮存在85±2°C条件下1小时，然后在室温下存放24±2小时，再进行初始测量。 CAPACITOR SHOULD BE STORED AT 85±2°C FOR 1 HR., AND THEN PLACED AT ROOM CONDITION FOR 24±2 HRS. BEFORE INITIAL MEASUREMENTS. 试验后处理POST-TREATMENT: 电容必须存放在室温下1-2小时。 CAPACITOR SHOULD BE STORED FOR 1 TO 2 HRS. AT ROOM CONDITION.			
		ΔC/C		Y5P: ±10% Y5U, Y5V: ±20%		
		IR		>1 000MΩ		
		TV		如第6项 PER ITEM 6		
12	针焰试验 FLAME TEST	电容离开火焰后自动熄灭。 THE CAPACITOR FLAME DISCONTINUES AS FOLLOWS.	电容应放在火焰中15秒钟，然后离开15秒钟，如此重复5次。 THE CAPACITOR SHOULD BE SUBJECTED TO APPLIED FLAME FOR 15 SEC. AND THEN REMOVED FOR 15 SEC. UNTIL 5 CYCLES ARE COMPLETED.			
		<table border="1"> <thead> <tr> <th>周期 CYCLE</th> <th>时间 TIME</th> </tr> </thead> <tbody> <tr> <td>1 TO 4</td> <td>30 SEC</td> </tr> <tr> <td>5</td> <td>60 SEC</td> </tr> </tbody> </table>		周期 CYCLE	时间 TIME	1 TO 4
周期 CYCLE	时间 TIME					
1 TO 4	30 SEC					
5	60 SEC					
13	自燃性 ACTIVE FLAMMABILITY	纱布不着火 THE CHEESE-CLOTH SHOULD NOT BE ON FIRE.	单个电容器应用纱布全部包住至少一层，但不多于两层。电容应承受放电20次，每次放电间隔5秒钟。AC电源应维持两分钟，最后放电。 THE CAPACITOR SHOULD BE INDIVIDUALLY WRAPPED IN AT LEAST ONE BUT NOT MORE THAN TWO COMPLETE LAYERS OF CHEESE-CLOTH. THE CAPACITOR SHOULD BE SUBJECTED TO 20 DISCHARGES. THE INTERVAL BETWEEN SUCCESSIVE DISCHARGES SHOULD BE 5 SEC. THE UAC SHOULD BE MAINTAINED FOR 2 MIN. AFTER THE LAST DISCHARGE.			
14	阻燃性 PASSIVE FLAMMABILITY	燃烧时间不超过30秒，棉纸不被点燃。 THE BURNING TIME SHOULD NOT EXCEED 30 SEC. THE TISSUE PAPER SHOULD NOT IGNITE.	电容器在下面试验中，火焰在适当的位置被最大燃烧，各个试验样品应只承受一次燃烧，燃烧时间：30秒钟。 THE CAPACITOR UNDER TEST SHOULD BE HELD IN THE FLAME IN THE POSITION WHICH BEST PROMOTES BURNING. EACH SPECIMEN SHOULD ONLY BE EXPOSED ONCE TO THE FLAME. TIME OF EXPOSURE TO FLAME: 30 SEC.			

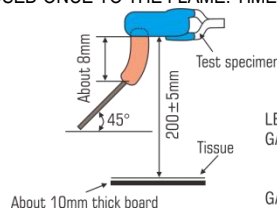
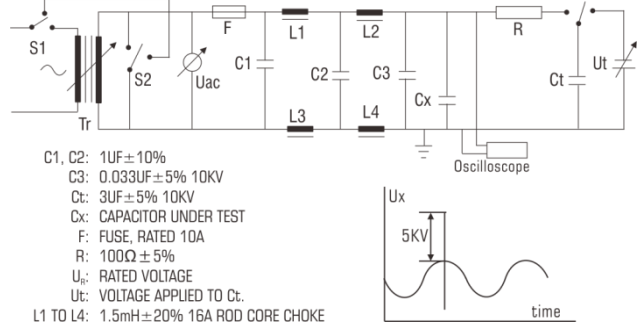
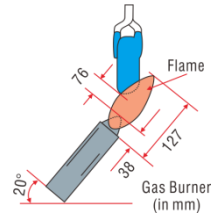
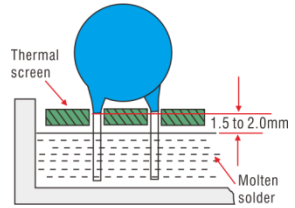

安规陶瓷电容器产品规格书 PRODUCT SPECIFICATIONS FOR SAFETY CEAMIC CAPACITOR

编号DOC NO.:	WD-SPEC-002A
版本REV.:	A/1
日期DATE:	2018-4-1
页码PAGE:	9 / 15

☐ 接上页

Continued from the preceding page

序 NO.	项目 ITEM	标准 SPECIFICATIONS	试验方法 TESTING METHOD																											
15	耐湿负荷 HUMIDITY LOADING	APP	没有可见损伤 NO MARKED DEFECT																											
		ΔC/C	Y5P: ±10% Y5U, Y5V: ±15%																											
		TANδ	Y5P, Y5U: <0.050 Y5V: <0.075																											
		IR	>3 000MΩ																											
		TV	如第6项 PER ITEM 6																											
16	寿命试验 LIFE TEST	APP	没有可见损伤 NO MARKED DEFECT																											
		ΔC/C	Y5P: ±10% Y5U, Y5V: ±15%																											
		IR	>3 000MΩ																											
		TV	如第6项 PER ITEM 6																											
<p>脉冲电压 IMPULSE VOLTAGE 每个供试验电容必须承受5KV (Y1为8KV) 脉冲电压三次, 然后再进行寿命试验。 EACH INDIVIDUAL CAPACITOR SHOULD BE SUBJECTED TO A 5KV (8KV FOR Y1) IMPULSES FOR THREE TIMES. AFTER THE CAPACITORS ARE APPLIED TO LIFE TEST.</p>  <p>在125+2/-0°C的条件下使用下表所要求的电压进行1000小时。 APPLY A VOLTAGE OF FOLLOWING TABLE FOR 1000 HRS. AT 125+2/-0°CX.</p> <table border="1" data-bbox="799 1025 1347 1173"> <thead> <tr> <th>应用电压 APPLIED VOLTAGE</th> </tr> </thead> <tbody> <tr> <td>AC510V(Y1使用AC850V), 另在每小时将电压增加AC1000V, 时间0.1秒。</td> </tr> <tr> <td>AC510V (AC850V FOR Y1), EXCEPT THAT ONCE EACH HOUR THE VOLTAGE IS INCREASED TO AC1000V(R.M.S.) FOR 0.1 SEC.</td> </tr> </tbody> </table> <p>试验后处理 POST-TREATMENT: 电容必须贮存在室温条件下一至二小时。 CAPACITOR SHOULD BE STORED FOR 1 TO 2 HRS. AT *ROOM CONDITION.</p>			应用电压 APPLIED VOLTAGE	AC510V(Y1使用AC850V), 另在每小时将电压增加AC1000V, 时间0.1秒。	AC510V (AC850V FOR Y1), EXCEPT THAT ONCE EACH HOUR THE VOLTAGE IS INCREASED TO AC1000V(R.M.S.) FOR 0.1 SEC.																									
应用电压 APPLIED VOLTAGE																														
AC510V(Y1使用AC850V), 另在每小时将电压增加AC1000V, 时间0.1秒。																														
AC510V (AC850V FOR Y1), EXCEPT THAT ONCE EACH HOUR THE VOLTAGE IS INCREASED TO AC1000V(R.M.S.) FOR 0.1 SEC.																														
17	温度特性 TEMPERATURE CHARACTERISTICS	Y5P: WITHIN ±10% Y5U: WITHIN +20/-55% Y5V: WITHIN +30/-80%	<p>电容器必须按照下表中的每一步骤进行测量。 THE CAPACITANCE MEASUREMENT SHOULD BE MADE AT EACH STEP SPECIFIED IN FOLLOWING TABLE.</p> <table border="1" data-bbox="762 1330 1385 1429"> <thead> <tr> <th>阶段 STEP</th> <th>1</th> <th>2</th> <th>3</th> <th>4</th> <th>5</th> </tr> </thead> <tbody> <tr> <td>温度 (°C)</td> <td>+20±2</td> <td>-25±2</td> <td>+20±2</td> <td>+85±2</td> <td>-20±2</td> </tr> <tr> <td>TEMPERATURE (°C)</td> <td></td> <td></td> <td></td> <td></td> <td></td> </tr> </tbody> </table>	阶段 STEP	1	2	3	4	5	温度 (°C)	+20±2	-25±2	+20±2	+85±2	-20±2	TEMPERATURE (°C)														
阶段 STEP	1	2	3	4	5																									
温度 (°C)	+20±2	-25±2	+20±2	+85±2	-20±2																									
TEMPERATURE (°C)																														
18	温度循环 TEMPERATURE AND IMMERSION CYCLE	APP	没有可见损伤 NO MARKED DEFECT																											
		ΔC/C	Y5P: ±10% Y5U, Y5V: ±15%																											
		TANδ	如第4项 PER ITEM 4																											
		IR	>3 000MΩ																											
		TV	如第6项 PER ITEM 6																											
<p>电容器应承受五次温度循环, 然后连续交替循环两次。 THE CAPACITOR SHOULD BE SUBJECTED TO 5 TEMPERATURE CYCLES, THEN CONSECUTIVELY TO 2 IMMERSION CYCLES.</p> <p>温度循环 TEMPERATURE CYCLE</p> <table border="1" data-bbox="807 1543 1337 1729"> <thead> <tr> <th>阶段 STEP</th> <th>温度 TEMPERATURE (°C)</th> <th>时间 TIME (MIN)</th> </tr> </thead> <tbody> <tr> <td>1</td> <td>-25+0/-3</td> <td>30</td> </tr> <tr> <td>2</td> <td>室温 ROOM TEMP.</td> <td>3</td> </tr> <tr> <td>3</td> <td>125+3/-0</td> <td>30</td> </tr> <tr> <td>4</td> <td>室温 ROOM TEMP.</td> <td>3</td> </tr> </tbody> </table> <p>交替循环 IMMERSION CYCLE</p> <table border="1" data-bbox="804 1753 1342 1890"> <thead> <tr> <th>阶段 STEP</th> <th>温度 TEMP (°C)</th> <th>时间 TIME (MIN)</th> <th>浸水 IMMERSION WATER</th> </tr> </thead> <tbody> <tr> <td>1</td> <td>65+5/-0</td> <td>0±3</td> <td>纯水CLEAN WATER</td> </tr> <tr> <td>2</td> <td>15</td> <td>15</td> <td>盐水SALT WATER</td> </tr> </tbody> </table> <p>预处理 PRE-TREATMENT: 电容器必须先贮存在85±2°C条件下1小时, 然后在室温下存放24±2小时, 再进行初始测量。 CAPACITOR SHOULD BE STORED AT 85±2°C FOR 1 HR., THEN PLACED AT ROOM CONDITION FOR 24±2 HRS.</p> <p>试验后处理 POST-TREATMENT: 电容必须贮存在室温条件下一至二小时。 CAPACITOR SHOULD BE STORED FOR 24±2 HRS. AT ROOM CONDITION.</p>			阶段 STEP	温度 TEMPERATURE (°C)	时间 TIME (MIN)	1	-25+0/-3	30	2	室温 ROOM TEMP.	3	3	125+3/-0	30	4	室温 ROOM TEMP.	3	阶段 STEP	温度 TEMP (°C)	时间 TIME (MIN)	浸水 IMMERSION WATER	1	65+5/-0	0±3	纯水CLEAN WATER	2	15	15	盐水SALT WATER	
阶段 STEP	温度 TEMPERATURE (°C)	时间 TIME (MIN)																												
1	-25+0/-3	30																												
2	室温 ROOM TEMP.	3																												
3	125+3/-0	30																												
4	室温 ROOM TEMP.	3																												
阶段 STEP	温度 TEMP (°C)	时间 TIME (MIN)	浸水 IMMERSION WATER																											
1	65+5/-0	0±3	纯水CLEAN WATER																											
2	15	15	盐水SALT WATER																											

安规陶瓷电容器产品规格书**PRODUCT SPECIFICATIONS FOR SAFETY CEAMIC CAPACITOR****6. 测量和使用注意事项****MEASURING AND APPLICATION NOTICE****6.1. 测量注意事项****MEASUREMENT NOTICE**

请在以下条件下测量。

PLEASE MEASURE UNDER THE FOLLOWING CONDITIONS.

6.1.1. 标准大气条件**STANDARD ATMOSPHERIC CONDITIONS**

除非另有规定，所有试验和测量应按在IEC 60068-1的5.3中规定的试验用标准大气条件下表进行。

UNLESS OTHERWISE SPECIFIED, ALL TESTS AND MEASUREMENTS SHALL BE MADE UNDER STANDARD ATMOSPHERIC CONDITIONS FOR TESTING AS GIVEN IN 5.3 OF IEC 60068-1.

温度, °C TEMPERATURE	相对湿度, % RELATIVE HUMIDITY	气压, KPA AIR PRESSURE
15~35	25~75	86~106

在进行测量之前，电容器应在测量温度下存放足够时间，以使整个电容器都达到这一温度。为此目的，规定与试验后恢复时间同样的时间，通常是足够的。

BEFORE THE MEASUREMENTS ARE MADE, THE CAPACITOR SHALL BE STORED AT THE MEASURING TEMPERATURE FOR A TIME SUFFICIENT TO ALLOW THE ENTIRE CAPACITOR TO REACH THIS TEMPERATURE. THE PERIOD AS PRESCRIBED FOR RECOVERY AT THE END OF A TEST IS NORMALLY SUFFICIENT FOR THIS PURPOSE.

在标准大气条件下进行测量，其测量结果存在争议时应采用仲裁温度（见7.1.3）重复测量。

TEST AND MEASUREMENT SHALL BE MADE UNDER STANDARD ATMOSPHERIC CONDITIONS FOR TESTING, IN THE EVENT OF A DISPUTE, THE MEASUREMENTS SHALL BE REPEATED USING ONE OF THE REFEREE TEMPERATURES (AS GIVEN IN 7.1.3).

当按某一顺序进行试验时，一个试验的最后测量可以作为下一试验的初始测量。

WHEN TESTS ARE CONDUCTED IN A SEQUENCE, THE FINAL MEASUREMENTS OF ONE TEST MAY BE TAKEN AS THE INITIAL MEASUREMENTS FOR THE SUCCEEDING TEST.

在测量期间，不应使电容器受到气流、阳光直射或可能引起误差的其他影响。

DURING MEASUREMENTS THE CAPACITOR SHALL NOT BE EXPOSED TO DRAUGHTS, DIRECT SUNLIGHT OR OTHER INFLUENCES LIKELY TO CAUSE ERROR.

6.1.2. 恢复条件**RECOVERY CONDITIONS**

除非另有规定，恢复应在试验用标准大气条件（见7.1.1）下进行。

UNLESS OTHERWISE SPECIFIED RECOVERY SHALL TAKE PLACE UNDER THE STANDARD ATMOSPHERIC CONDITIONS FOR TESTING (7.1.1).

如果恢复必须在严格控制条件下进行，应采用IEC 60068-1中5.4.1的控制条件。

IF RECOVERY UNDER CLOSELY CONTROLLED CONDITIONS IS NECESSARY, THE CONTROLLED RECOVERY CONDITIONS OF 5.4.1 OF IEC 60068-1 SHALL BE USED.

除非有关规范另有规定，恢复时间应为1H~2H。

UNLESS OTHERWISE SPECIFIED IN THE RELEVANT SPECIFICATION, A DURATION OF 1 H TO 2 H SHALL BE USED.

6.1.3. 仲裁条件**REFEREE CONDITIONS**

温度, °C TEMPERATURE	相对湿度, % RELATIVE HUMIDITY	气压, KPA AIR PRESSURE
25±1	48~52	86~106

安规陶瓷电容器产品规格书

PRODUCT SPECIFICATIONS FOR SAFETY CEAMIC CAPACITOR

在仲裁情况下，应选用IEC 60068-1中5.2中规定的仲裁试验用标准大气条件。

FOR REFEREE PURPOSES, ONE OF THE STANDARD ATMOSPHERIC CONDITIONS FOR REFEREE TESTS TAKEN FROM 5.2 OF IEC 60068-1, AS GIVEN IN TABLE 1 BELOW, SHALL BE SELECTED:

6.2. 工作电压

OPERATING VOLTAGE

在交流电路或纹波电路中使用直流额定电压电容器时，请务必将外加电压的VP-P值或包含直流偏置电压的VO-P值维持在额定电压范围内。若向电路施加电压，开始或停止时可能会因谐振或切换产生暂时的异常电压。请务必使用额定电压范围包含这些异常电压的电容器。

WHEN DC-RATED CAPACITORS ARE TO BE USED IN AC OR RIPPLE CURRENT CIRCUITS, BE SURE TO MAINTAIN THE VP-P VALUE OF THE APPLIED VOLTAGE OR THE VO-P WHICH CONTAINS DC BIAS WITHIN THE RATED VOLTAGE RANGE. WHEN THE VOLTAGE IS APPLIED TO THE CIRCUIT, STARTING OR STOPPING MAY GENERATE IRREGULAR VOLTAGE FOR A TRANSIT PERIOD BECAUSE OF RESONANCE OR SWITCHING. BE SURE TO USE A CAPACITOR WITH A RATED VOLTAGE RANGE THAT INCLUDES THESE IRREGULAR VOLTAGES.

电压 VOLTAGE	直流电压 DC VOLTAGE	直流+交流电压 DC+AC VOLTAGE	交流电压 AC VOLTAGE	脉冲电压 PULSE VOLTAGE
测量位置 POSITIONAL MEASUREME NT				

6.3. 工作温度与自生热

OPERATING TEMPERATURE AND SELF-GENERATED HEAT

适用于Y5P、Y5U、Y5V特性。

APPLY TO Y5P, Y5U, Y5V CHAR.

电容器的表面温度应保持在额定工作温度范围的上限以下。务必考虑到电容器的自生热。电容器在高频电流、脉冲电流等使用时可能会因介电损耗发出自生热。外加电压应使自生热等负荷在25°C周围温度条件下不超过20°C范围。测量时应使用Ø0.1MM小热容量(K)的热电偶，而且电容器不应受到其它元件的散热或环境温度波动影响。过热可能会导致电容器特性及可靠性下降。(切勿在冷却风扇运转时进行测量。否则无法确保测量数据的精确性。)

KEEP THE SURFACE TEMPERATURE OF A CAPACITOR BELOW THE UPPER LIMIT OF ITS RATED OPERATING TEMPERATURE RANGE. BE SURE TO TAKE INTO ACCOUNT THE HEAT GENERATED BY THE CAPACITOR ITSELF. WHEN THE CAPACITOR IS USED IN A HIGH FREQUENCY CURRENT, PULSE CURRENT OR SIMILAR CURRENT, IT MAY HAVE SELF-GENERATED HEAT DUE TO DIELECTRIC LOSS. APPLIED VOLTAGE LOAD SHOULD BE SUCH THAT SELF-GENERATED HEAT IS WITHIN 20°C UNDER THE CONDITION WHERE THE CAPACITOR IS SUBJECTED AT AN ATMOSPHERE TEMPERATURE OF 25°C. WHEN MEASURING, USE A THERMOCOUPLE OF SMALL THERMAL CAPACITY-K OF Ø0.1MM UNDER CONDITIONS WHERE THE CAPACITOR IS NOT AFFECTED BY RADIANT HEAT FROM OTHER COMPONENTS OR WIND FROM SURROUNDINGS. EXCESSIVE HEAT MAY LEAD TO DETERIORATION OF THE CAPACITOR'S CHARACTERISTICS AND RELIABILITY. (NEVER ATTEMPT TO PERFORM MEASUREMENT WITH THE COOLING FAN RUNNING. OTHERWISE, ACCURATE MEASUREMENT CANNOT BE ENSURED.)

6.4. 耐电压的测试条件

TEST CONDITION FOR WITHSTANDING VOLTAGE

6.4.1. 测试设备

TEST EQUIPMENT

交流耐压的测试设备应具有能够产生类似于50/60HZ正弦波的性能。如果施加变形的正弦波或超过规定电压值的过载电压后，则可能会导致故障。

TEST EQUIPMENT FOR AC WITHSTANDING VOLTAGE SHOULD BE USED WITH THE PERFORMANCE OF THE WAVE SIMILAR TO 50/60HZ SINE WAVE. IF THE DISTORTED SINE WAVE OR OVERLOAD EXCEEDING THE SPECIFIED

安规陶瓷电容器产品规格书**PRODUCT SPECIFICATIONS FOR SAFETY CEAMIC CAPACITOR**

VOLTAGE VALUE IS APPLIED, A DEFECT MAY BE CAUSED.

6.4.2. 电压外加方法

VOLTAGE APPLIED METHOD

测试耐电压时，电容器的引线或端子应与耐电压测试设备的输出端连接牢固；然后再将电压从近零增加到测试电压(速度150V/s)。

WHEN THE WITHSTANDING VOLTAGE IS APPLIED, CAPACITOR'S LEAD OR TERMINAL SHOULD BE FIRMLY CONNECTED TO THE OUTPUT OF THE WITHSTANDING VOLTAGE TEST EQUIPMENT, AND THEN THE VOLTAGE SHOULD BE RAISED FROM NEAR ZERO TO THE TEST VOLTAGE (RISING SPEED 150V/S).

如果测试电压不从近零逐渐提高而是直接施加在电容器上，则施加时应包含过零点。测试结束时，测试电压应降到近零；然后再将电容器引线或端子从耐电压测试设备的输出端取下。

IF THE TEST VOLTAGE WITHOUT THE RAISE FROM NEAR ZERO VOLTAGE WOULD BE APPLIED DIRECTLY TO CAPACITOR, TEST VOLTAGE SHOULD BE APPLIED WITH THE ZERO CROSS. AT THE END OF THE TEST TIME, THE TEST VOLTAGE SHOULD BE REDUCED TO NEAR ZERO, AND THEN CAPACITOR'S LEAD OR TERMINAL SHOULD BE TAKEN OFF THE OUTPUT OF THE WITHSTANDING VOLTAGE TEST EQUIPMENT.

如果测试电压不从近零逐渐提高而是直接施加在电容器上，则可能会出现浪涌电压，从而导致故障。

IF THE TEST VOLTAGE WITHOUT THE RAISE FROM NEAR ZERO VOLTAGE WOULD BE APPLIED DIRECTLY TO CAPACITOR, THE SURGE VOLTAGE MAY ARISE, AND THEREFORE, A DEFECT MAY BE CAUSED.

过零点是指电压正弦通过0V的位置。参见右图。

ZERO CROSS IS THE POINT WHERE VOLTAGE SINE WAVE PASSES 0V. SEE FIGURE AT RIGHT.

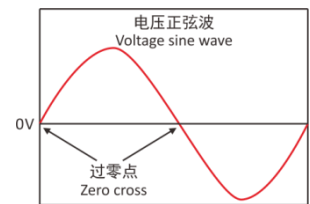

6.5. 失效安全性

FAIL-SAFE

电容器损坏时，失效可能会导致短路。为了避免在短路时引起触电、冒烟、火灾等危险情况，请在电路中使用熔丝等元件来设置自动防故障功能。

WHEN CAPACITOR WOULD BE BROKEN, FAILURE MAY RESULT IN A SHORT CIRCUIT. BE SURE TO PROVIDE AN APPROPRIATE FAIL-SAFE FUNCTION LIKE A FUSE ON YOUR PRODUCT IF FAILURE WOULD RESULT IN AN ELECTRIC SHOCK, FIRE OR FUMING.

6.6. 电容器容量变化

CAPACITANCE CHANGE OF CAPACITORS

6.6.1. SL特性

SL CHAR.

电容量可能会因环境温度或外加电压而发生轻微变化。若要将本产品用于严格的时间常数电路，请与我公司联系。

CAPACITANCE MIGHT CHANGE A LITTLE DEPENDING ON A SURROUNDING TEMPERATURE OR AN APPLIED VOLTAGE. PLEASE CONTACT US IF YOU USE FOR THE STRICT CONSTANT TIME CIRCUIT.

6.6.2. Y5P、Y5U、Y5V特性

Y5P, Y5U, Y5V CHAR.

电容器具有老化特性；因此，电容器若长时间使用，其静电容量会逐渐降低。而且，静电容量还可能会因环境温度或外加电压而发生巨大变化。所以不适合用于时间常数电路。

CAPACITORS HAVE AN AGING CHARACTERISTIC, WHEREBY THE CAPACITOR CONTINUALLY DECREASES ITS CAPACITANCE SLIGHTLY IF THE CAPACITOR IS LEFT ON FOR A LONG TIME. MOREOVER, CAPACITANCE MIGHT CHANGE GREATLY DEPENDING ON THE SURROUNDING TEMPERATURE OR AN APPLIED VOLTAGE. SO, IT IS NOT LIKELY TO BE SUITABLE FOR USE IN A CONSTANT TIME CIRCUIT.

安规陶瓷电容器产品规格书

PRODUCT SPECIFICATIONS FOR SAFETY CEAMIC CAPACITOR

若需详情，请与我公司联系。

PLEASE CONTACT US IF YOU NEED DETAILED INFORMATION.

6.7. 使用设备检查

PERFORMANCE CHECK BY EQUIPMENT

使用电容器之前，请先检查设备的性能和特性没有问题。

BEFORE USING A CAPACITOR, CHECK THAT THERE IS NO PROBLEM IN THE EQUIPMENT'S PERFORMANCE AND THE SPECIFICATIONS.

一般而言，二类瓷（Y5P、Y5U、Y5V特性）陶瓷电容器的静电容量具有电压相关特性和温度相关特性。所以，其电容值可能会随设备的工作条件而发生变化。因此，一定要确认仪器接收性能对电容器的静电容量值变化的影响，如漏电流和静噪特性。

GENERALLY SPEAKING, CLASS 2 (B/E/F CHAR.) CERAMIC CAPACITORS HAVE VOLTAGE DEPENDENCE CHARACTERISTICS AND TEMPERATURE DEPENDENCE CHARACTERISTICS IN CAPACITANCE. SO, THE CAPACITANCE VALUE MAY CHANGE DEPENDING ON THE OPERATING CONDITION IN THE EQUIPMENT. THEREFORE, BE SURE TO CONFIRM THE APPARATUS PERFORMANCE OF RECEIVING INFLUENCE IN THE CAPACITANCE VALUE CHANGE OF A CAPACITOR, SUCH AS LEAKAGE CURRENT AND NOISE SUPPRESSION CHARACTERISTIC.

此外，必要时还要检查电容器在设备中的防电涌性能，因为通过电路的感应，浪涌电压可能会超过规定值。

MOREOVER, CHECK THE SURGE-PROOF ABILITY OF A CAPACITOR IN THE EQUIPMENT, IF NEEDED, BECAUSE THE SURGE VOLTAGE MAY EXCEED SPECIFIC VALUE BY THE INDUCTANCE OF THE CIRCUIT.

6.8. 贮存与使用条件

OPERATING AND STORAGE ENVIRONMENT

电容器绝缘包封层不是完美的密封形式，因此，请勿将电容器存放在腐蚀性气体中，尤其是存在氯气、硫气、酸、碱、盐等场所，同时应防潮。

THE INSULATING COATING OF CAPACITORS DOES NOT FORM A PERFECT SEAL; THEREFORE, DO NOT USE OR STORE CAPACITORS IN A CORROSIVE ATMOSPHERE, ESPECIALLY WHERE CHLORIDE GAS, SULFIDE GAS, ACID, ALKALI, SALT OR THE LIKE ARE PRESENT. AND AVOID EXPOSURE TO MOISTURE.

在对本产品进行清洗、焊接或成型前，请先在指定设备上测试经清洗、焊接或成型的产品的性能，以确定上述过程不会影响产品质量。

BEFORE CLEANING, BONDING, OR MOLDING THIS PRODUCT, VERIFY THAT THESE PROCESSES DO NOT AFFECT PRODUCT QUALITY BY TESTING THE PERFORMANCE OF A CLEANED, BONDED OR MOLDED PRODUCT IN THE INTENDED EQUIPMENT.

电容器应存放在温度及相对湿度分别不超出-10~40°C及15~85%范围的场所。请在6个月内使用电容器。STORE THE CAPACITORS WHERE THE TEMPERATURE AND RELATIVE HUMIDITY DO NOT EXCEED 5 TO 40 DEGREES CENTIGRADE AND 20 TO 70%. USE CAPACITORS WITHIN 6 MONTHS AFTER DELIVERED.

6.9. 焊锡和安装

SOLDERING AND MOUNTING

6.9.1. 振动与碰撞

VIBRATION AND IMPACT

使用时请勿使电容器受到过度冲击或振动。

DO NOT EXPOSE A CAPACITOR OR ITS LEADS TO EXCESSIVE SHOCK OR VIBRATION DURING USE.

6.9.2. 焊锡

SOLDERING

当在PCB/PWB焊锡这个产品时，不要超过电容器的焊锡耐热性标准（260°C，3S）。过度的热量会使电容器

安规陶瓷电容器产品规格书

PRODUCT SPECIFICATIONS FOR SAFETY CEAMIC CAPACITOR

内部焊锡熔化，可能导致热冲击而使陶瓷介质出现暗裂。

WHEN SOLDERING THIS PRODUCT TO A PCB/PWB, DO NOT EXCEED THE SOLDER HEAT RESISTANCE SPECIFICATIONS (260°C, 3S) OF THE CAPACITOR. SUBJECTING THIS PRODUCT TO EXCESSIVE HEATING COULD MELT THE INTERNAL JUNCTION SOLDER AND MAY RESULT IN THERMAL SHOCKS THAT CAN CRACK THE CERAMIC ELEMENT.

当使用烙铁进行手工焊锡时，应该遵照下列条件：

WHEN SOLDERING CAPACITOR WITH A SOLDERING IRON, IT SHOULD BE PERFORMED IN THE FOLLOWING CONDITIONS.

焊锡温度：320°C最大

TEMPERATURE OF IRON-TIP: 320 DEGREES C. MAX.

烙铁头：不超过40W

SOLDERING IRON WATTAGE: 40W MAX.

焊锡时间：不超过3.0秒

SOLDERING TIME: 3.0 SEC. MAX.

6.9.3. 压焊、树脂涂层与包封

BONDING, RESIN MOLDING AND COATING

在压焊、树脂涂层和封膜之前，请先使用指定设备确认对产品没有影响，然后再进行使用。

BEFORE BONDING, MOLDING OR COATING THIS PRODUCT, VERIFY THAT THESE PROCESSES DO NOT AFFECT THE QUALITY OF CAPACITOR BY TESTING THE PERFORMANCE OF THE BONDED, MOLDED OR COATED PRODUCT IN THE INTENDED EQUIPMENT.

在粘合、树脂涂层、封膜的干燥、硬化条件使用到有机溶剂（乙酸乙酯、甲基乙酮、甲苯等），可能会破坏电容器的包封树脂，而造成短路不良。

IN CASE THE AMOUNT OF APPLICATIONS, DRYNESS/HARDENING CONDITIONS OF ADHESIVES AND MOLDING RESINS CONTAINING ORGANIC SOLVENTS (ETHYL ACETATE, METHYL ETHYL KETONE, TOLUENE, ETC.) ARE UNSUITABLE, THE OUTER COATING RESIN OF A CAPACITOR IS DAMAGED BY THE ORGANIC SOLVENTS AND IT MAY RESULT, WORST CASE, IN A SHORT CIRCUIT.

粘合、树脂涂层、封膜厚度的偏差可能会在冷却与加热过程中使电容器的包封树脂和/或陶瓷介质破裂。
THE VARIATION IN THICKNESS OF ADHESIVE, MOLDING RESIN OR COATING MAY CAUSE OUTER COATING RESIN CRACKING AND/OR CERAMIC ELEMENT CRACKING OF A CAPACITOR IN A TEMPERATURE CYCLING.

6.9.4. 清洗（超声波清洗）

CLEANING (ULTRASONIC CLEANING)

要进行超声波清洗，应遵守下列条件。

TO PERFORM ULTRASONIC CLEANING, OBSERVE THE FOLLOWING CONDITIONS.

清洗槽容量：每升输出功率20瓦特或以下。

RINSE BATH CAPACITY: OUTPUT OF 20 WATTS PER LITER OR LESS.

清洗时间：最多5分钟。

RINSING TIME: 5 MIN. MAXIMUM.

不得直接振动 PCB/PWB。

DO NOT VIBRATE THE PCB/PWB DIRECTLY.

过度的超声波清洗会导致导线的过载损坏。

EXCESSIVE ULTRASONIC CLEANING MAY LEAD TO FATIGUE DESTRUCTION OF THE LEAD WIRES.