

■ PRODUCT CHARACTERISTICS

VDSS	40V
$R_{DS(on)Typ}(@V_{GS}=10V)$	4.2mΩ
$R_{DS(on)Typ}(@V_{GS}=4.5V)$	6.5mΩ
ID	90A

■ APPLICATIONS

- Load switching
- Hard switched and high frequency circuits
- Uninterruptible power supply

■ FEATURES

- High density cell design for ultra low Rdson
- Fully characterized avalanche voltage and current
- Good stability and uniformity with high E_{AS}
- Excellent package for good heat dissipation
- Special process technology for high ESD capability

■ ORDER INFORMATION

Order codes		Package	Packing
Halogen-Free	Halogen		
N/A	MOT4160G	PDFN5X6-8L	5000Pieces/Reel

■ ABSOLUTE MAXIMUM RATINGS ($T_J=25^{\circ}C$ Unless Otherwise Noted)

Parameter	Symbol	Rating	Unit
Drain-Source Voltage	V_{DS}	40	V
Gate-Source Voltage	V_{GS}	± 20	V
Drain Current-Continuous	I_D	90	A
Drain Current-Continuous($T_C=100^{\circ}C$)	$I_D(100^{\circ}C)$	63.5	A
Pulsed Drain Current	I_{DM}	330	A
Maximum Power Dissipation	P_D	65	W
Thermal Resistance,Junction-to-Case	$R_{\theta JC}$	2.3	$^{\circ}C/W$
Derating factor		0.43	$W/^{\circ}C$
Operating Junction and Storage Temperature Range	T_J, T_{STG}	-55 To 175	$^{\circ}C$

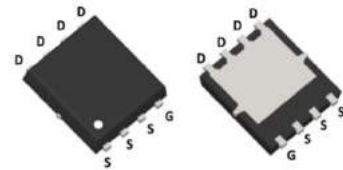
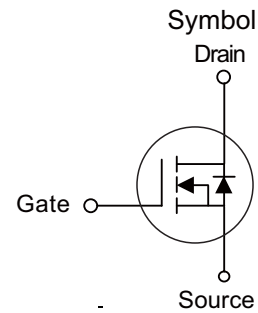

PDFN3X3-8L

■ ELECTRICAL CHARACTERISTICS ($T_c=25^\circ\text{C}$ unless otherwise specified)

Parameter	Symbol	Condition	Min	Typ	Max	Unit
Off characteristics						
Drain-Source Breakdown Voltage	BV_{DSS}	$V_{GS}=0V, I_D=250\mu A$	40	45	-	V
Zero Gate Voltage Drain Current	I_{DSS}	$V_{DS}=40V, V_{GS}=0V$	-	-	1	μA
Gate-Body Leakage Current	I_{GSS}	$V_{GS}=\pm 20V, V_{DS}=0V$	-	-	± 100	nA
On characteristics ^(Note 3)						
Gate Threshold Voltage	$V_{GS(th)}$	$V_{DS}=V_{GS}, I_D=250\mu A$	1.2	1.9	2.5	V
Drain-Source On-State Resistance	$R_{DS(on)}$	$V_{GS}=10V, I_D=20A$	-	4.2	6.0	m Ω
		$V_{GS}=4.5V, I_D=10A$	-	6.5	8.0	
Forward Transconductance	g_{FS}	$V_{DS}=10V, I_D=20A$	26	-	-	S
Dynamic characteristics ^(Note 4)						
Input Capacitance	C_{iss}	$V_{DS}=20V, V_{GS}=0V,$ $F=1.0MHz$	-	5000	-	PF
Output Capacitance	C_{oss}		-	898	-	PF
Reverse Transfer Capacitance	C_{rss}		-	351	-	PF
Switching characteristics ^(Note 4)						
Turn-on Delay Time	$t_{d(on)}$	$V_{DD}=20V, I_D=20A, R_L=1\Omega$ $V_{GS}=10V, R_G=3\Omega$	-	15	-	nS
Turn-on Rise Time	t_r		-	18	-	nS
Turn-Off Delay Time	$t_{d(off)}$		-	52	-	nS
Turn-Off Fall Time	t_f		-	23	-	nS
Total Gate Charge	Q_g	$V_{DS}=20V, I_D=20A,$ $V_{GS}=10V$	-	90	-	nC
Gate-Source Charge	Q_{gs}		-	14	-	nC
Gate-Drain Charge	Q_{gd}		-	22	-	nC
Drain-source diode characteristics						
Diode Forward Voltage ^(Note 3)	V_{SD}	$V_{GS}=0V, I_S=20A$	-	-	1.2	V
Diode Forward Current ^(Note 2)	I_S		-	-	90	A
Reverse Recovery Time	t_{rr}	$T_J = 25^\circ\text{C}, I_F = 20A$ $di/dt = 100A/\mu s$ ^(Note 3)	-	42	-	nS
Reverse Recovery Charge	Q_{rr}		-	45	-	nC
Forward Turn-On Time	t_{on}	Intrinsic turn-on time is negligible (turn-on is dominated by LS+LD)				

Notes:

1. Repetitive Rating: Pulse width limited by maximum junction temperature.
2. Surface Mounted on FR4 Board, $t \leq 10$ sec.
3. Pulse Test: Pulse Width $\leq 300\mu s$, Duty Cycle $\leq 2\%$.
4. Guaranteed by design, not subject to production

■ TYPICAL CHARACTERISTICS

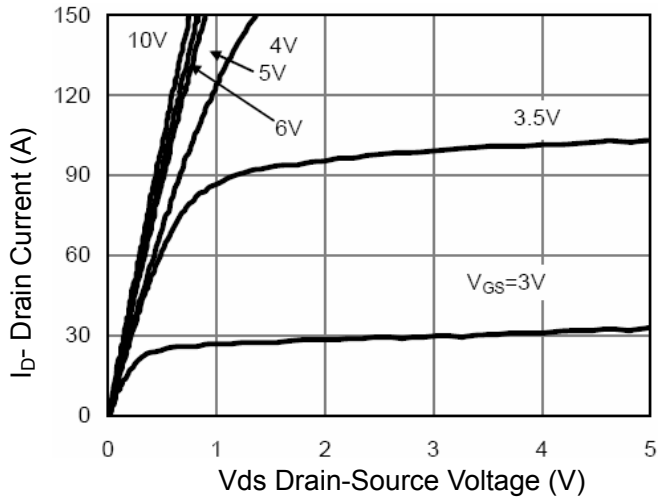

Figure 1 Output Characteristics

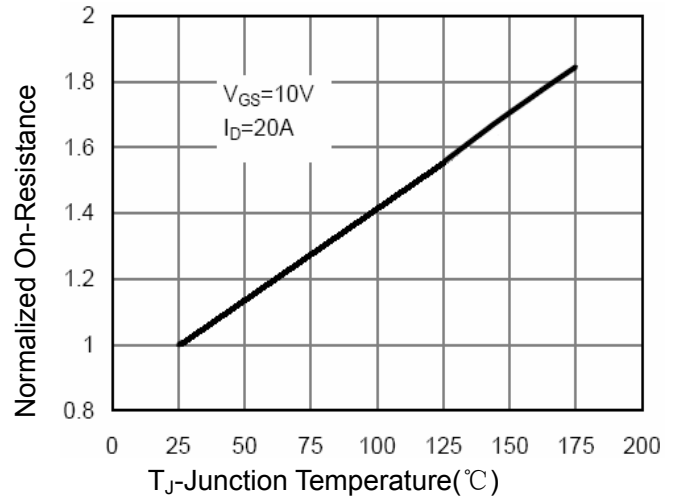

Figure 2 R_{dson} -Junction Temperature

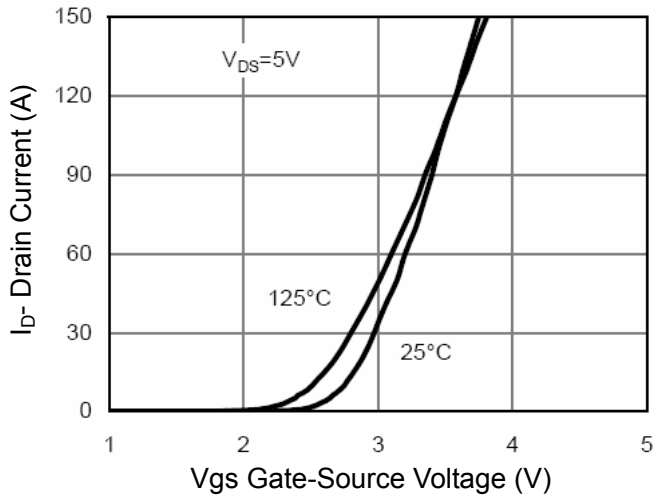

Figure 3 Transfer Characteristics

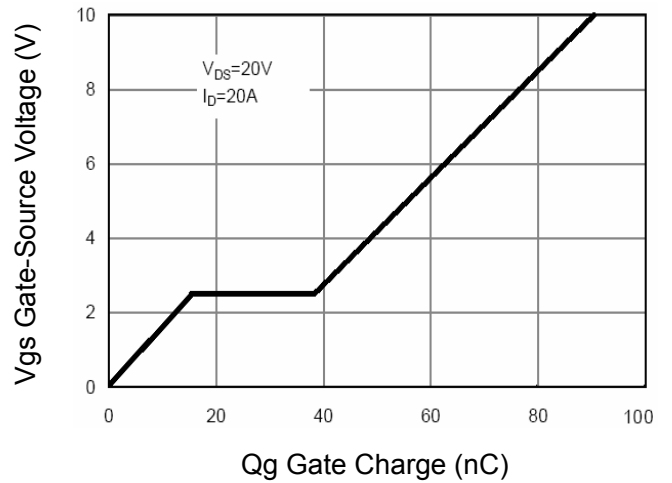

Figure 4 Gate Charge

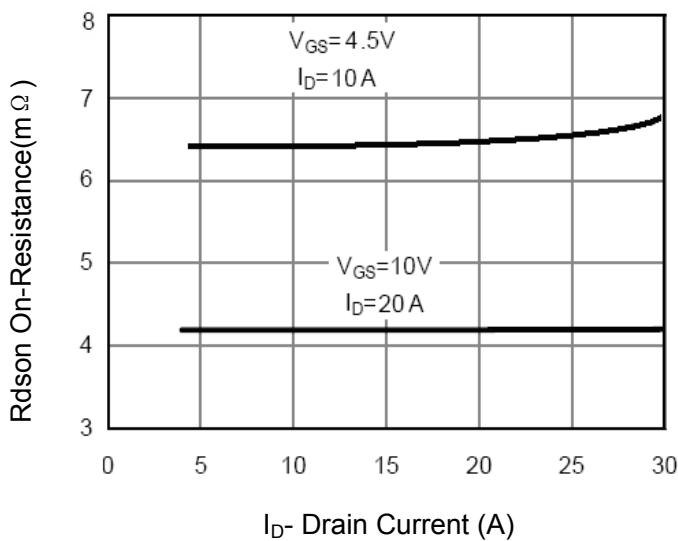

Figure 5 R_{dson} - Drain Current

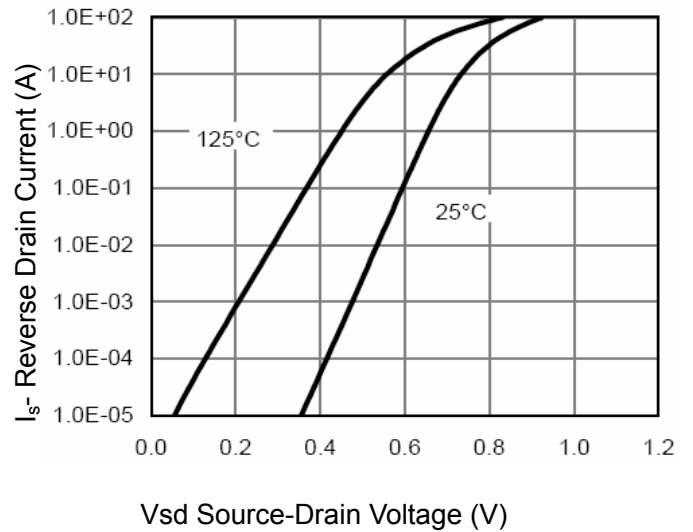

Figure 6 Source- Drain Diode Forward

■ TYPICAL CHARACTERISTICS

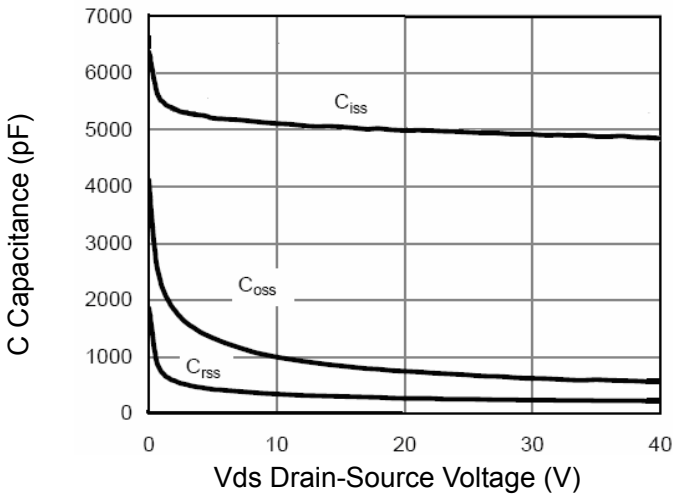

Figure 7 Capacitance vs Vds

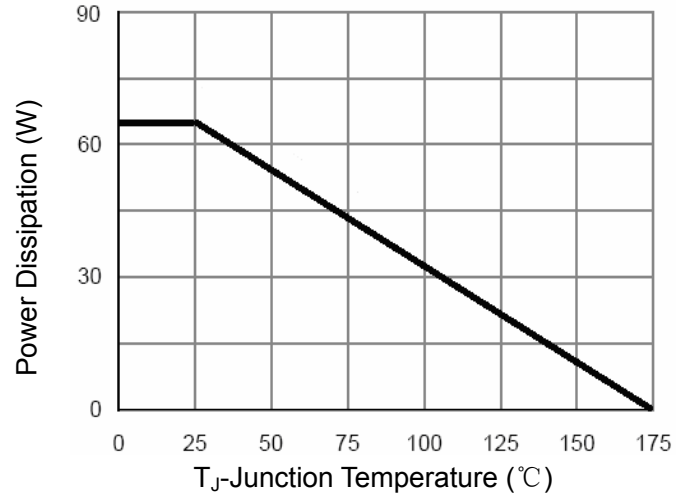

Figure 8 Power De-rating

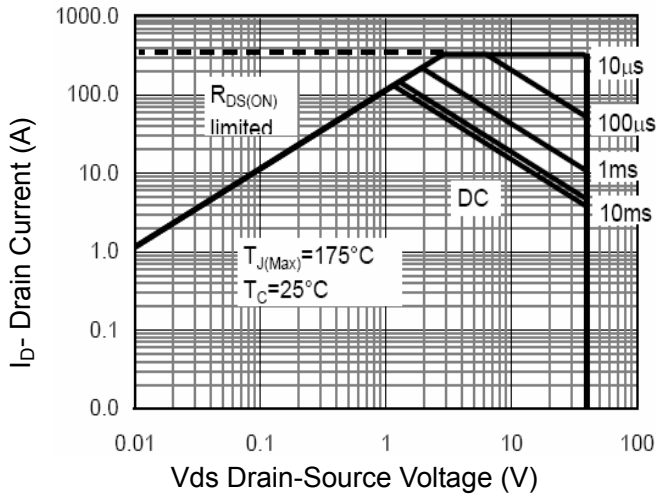

Figure 9 Safe Operation Area

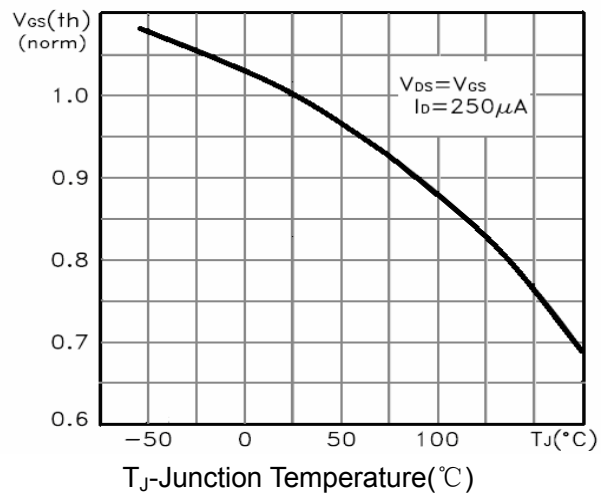

Figure 10 $V_{GS(th)}$ vs Junction Temperature

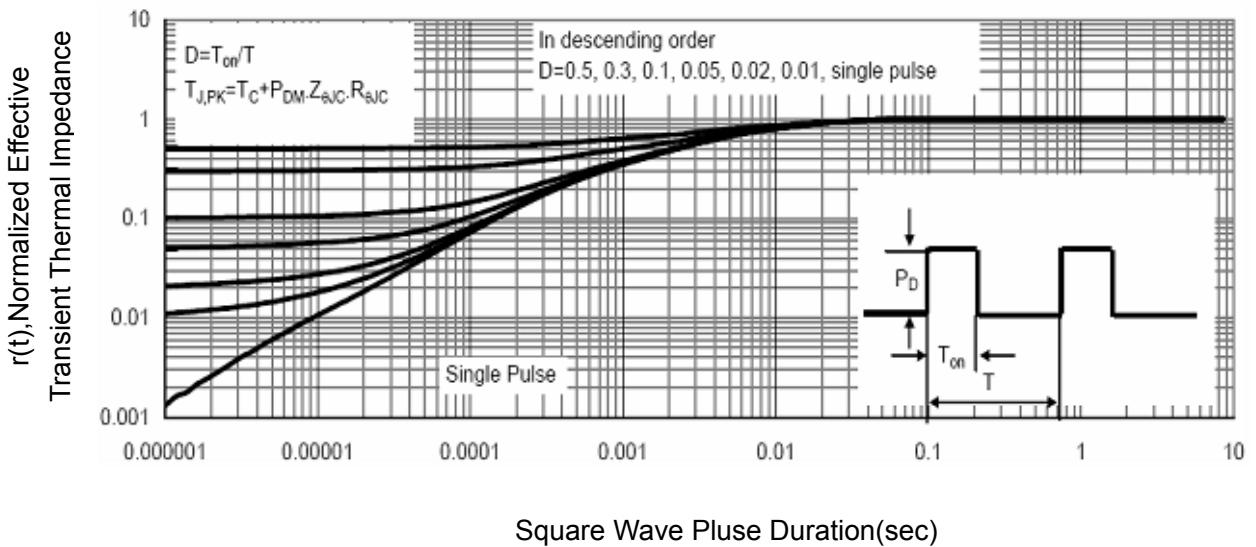
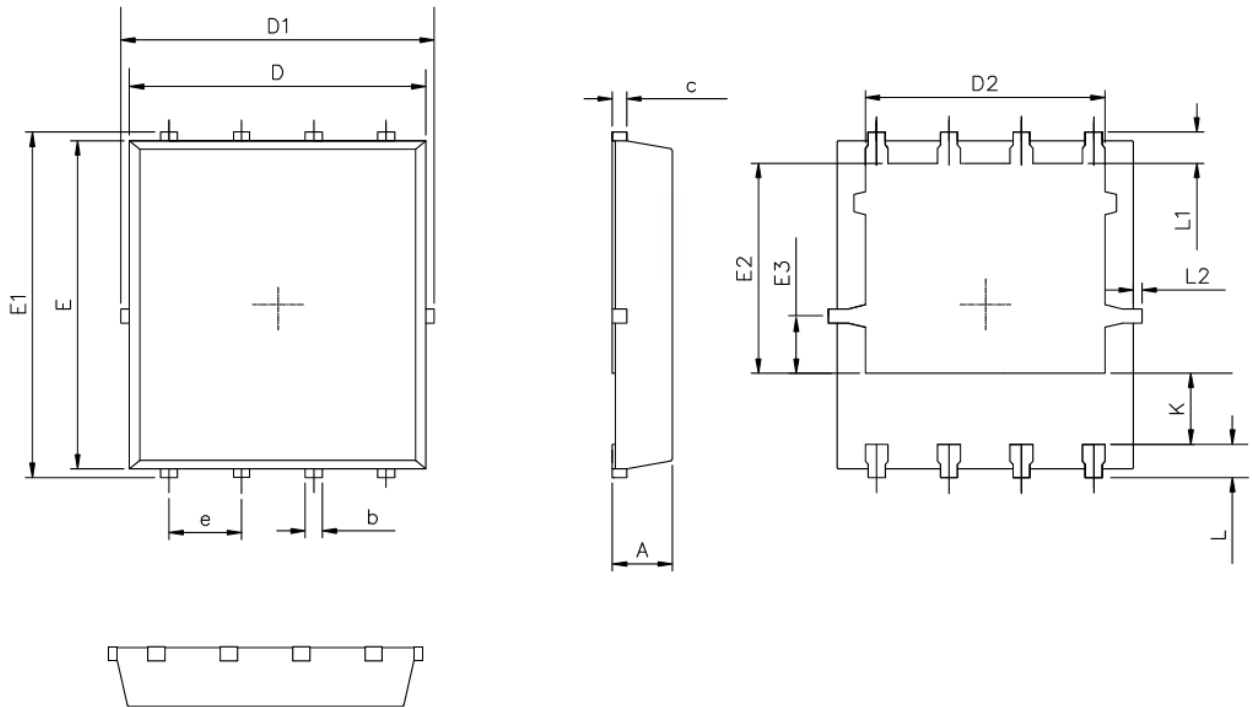
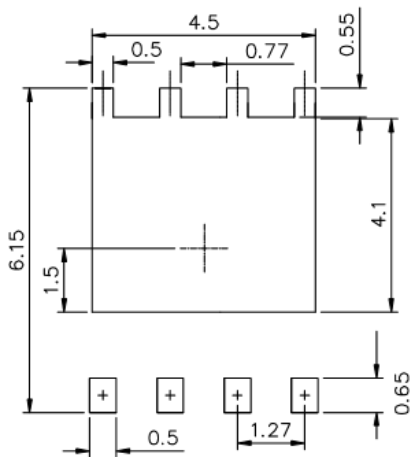

Figure 11 Normalized Maximum Transient Thermal Impedance

■ PDFN5X6-8L Package Mechanical Data



RECOMMENDED LAND PATTERN



UNIT:mm

	MIN	NOM	MAX
A	0.90	1.00	1.10
b	0.25	0.35	0.50
c	0.10	0.20	0.30
D	4.80	5.00	5.30
D1	4.90	5.10	5.50
D2	3.92	4.02	4.20
E	5.65	5.75	5.85
E1	5.90	6.05	6.20
E2	3.325	3.525	3.775
E3	0.80	0.90	1.00
e		1.27	
L	0.40	0.55	0.70
L1		0.65	
L2	0.00		0.15
K	1.00	1.30	1.50