

■ PRODUCT CHARACTERISTICS

VDSS	30V
$R_{DS(on)}$ typ(@ $V_{GS}=10V$ )	2.5m $\Omega$
$R_{DS(on)}$ typ(@ $V_{GS}=4.5V$ )	4.0m $\Omega$
ID	110A

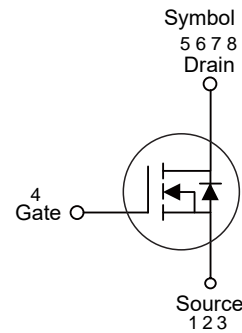

■ APPLICATIONS

- Portable Equipment and Battery Powered systems.
- Power Management in Notebook Computer

■ FEATURES

- Lower  $R_{DS(ON)}$  to Minimize Conduction Losses
- Reliable and Rugged
- ROHS Compliant & Halogen-Free
- 100% UIS and Rg Tested

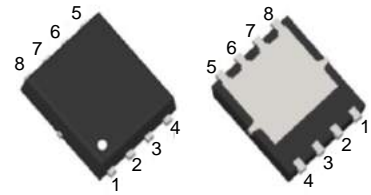

PDFN5X6-8L

■ ORDER INFORMATION

Order codes		Package	Packing
Halogen-Free	Halogen		
N/A	MOT3140G	PDFN5X6	5000Pieces/Reel

■ ABSOLUTE MAXIMUM RATINGS ( $T_J=25^{\circ}C$  Unless Otherwise Noted)

PARAMETER	SYMBOL	RATINGS	UNIT
Drain-Source Voltage	$V_{DSS}$	30	V
Gate-Source Voltage	$V_{GSS}$	$\pm 20$	V
Continuous Drain Current	$I_D$	110	A
Continuous Drain Current ( $T_C=100^{\circ}C$ )	$I_D$	77.8	A
Pulsed Drain Current	$I_{DM}$	440	A
Power Dissipation	$P_D$	68	W
Single pulse avalanche energy	$E_{AS}$	350	mJ
Operating Junction and Storage Temperature Range	$T_J, T_{STG}$	-55 ~ +150	$^{\circ}C$

■ THERMAL DATA

PARAMETER	SYMBOL	RATINGS	UNIT
Junction to Case	$\theta_{JC}$	1.83	$^{\circ}C/W$

■ ELECTRICAL CHARACTERISTICS ( $T_C=25^\circ\text{C}$  unless otherwise specified)

Parameter	Symbol	Test conditions	Min.	Typ.	Max.	Unit
Off characteristics						
Drain-Source Breakdown Voltage	$BV_{DSS}$	$V_{GS}=0V, I_D=250\mu A$	30	-	-	V
Zero Gate Voltage Drain Current	$I_{DSS}$	$V_{DS}=30V, V_{GS}=0V$	-	-	1	$\mu A$
Gate-Body Leakage Current	$I_{GSS}$	$V_{GS}=\pm 20V, V_{DS}=0V$	-	-	$\pm 100$	nA
On characteristics						
Gate Threshold Voltage	$V_{GS(th)}$	$V_{DS}=V_{GS}, I_D=250\mu A$	1	1.6	2.5	V
Drain-Source On-State Resistance	$R_{DS(on)}$	$V_{GS}=10V, I_D=20A$	-	2.5	4.0	m $\Omega$
		$V_{GS}=4.5V, I_D=20A$	-	4.5	7.0	m $\Omega$
Forward Transconductance	$g_{FS}$	$V_{DS}=5V, I_D=20A$	10	-	-	S
Dynamic characteristics						
Input Capacitance	$C_{iss}$	$V_{DS}=15V, V_{GS}=0V,$ $F=1.0MHz$	-	3009	-	PF
Output Capacitance	$C_{oss}$		-	451	-	PF
Reverse Transfer Capacitance	$C_{rss}$		-	403	-	PF
Switching characteristics						
Turn-on Delay Time	$t_{d(on)}$	$V_{DD}=15V, I_D=20A$ $V_{GS}=4.5V, R_{GEN}=1.8\Omega$	-	20	-	nS
Turn-on Rise Time	$t_r$		-	15	-	nS
Turn-Off Delay Time	$t_{d(off)}$		-	60	-	nS
Turn-Off Fall Time	$t_f$		-	10	-	nS
Total Gate Charge	$Q_g$	$V_{DS}=15V, I_D=20A,$ $V_{GS}=10V$	-	66.3	-	nC
Gate-Source Charge	$Q_{gs}$		-	7.0	-	nC
Gate-Drain Charge	$Q_{gd}$		-	17.2	-	nC
Drain-source diode characteristics						
Diode Forward Voltage	$V_{SD}$	$V_{GS}=0V, I_S=20A$	-	-	1.2	V
Diode Forward Current	$I_S$	-	-	-	110	A
Reverse Recovery Time	$t_{rr}$	$T_J = 25^\circ\text{C}, I_F = 20A$ $di/dt = 100A/\mu s$	-	29	-	nS
Reverse Recovery Charge	$Q_{rr}$		-	32	-	nC

■ TYPICAL CHARACTERISTICS

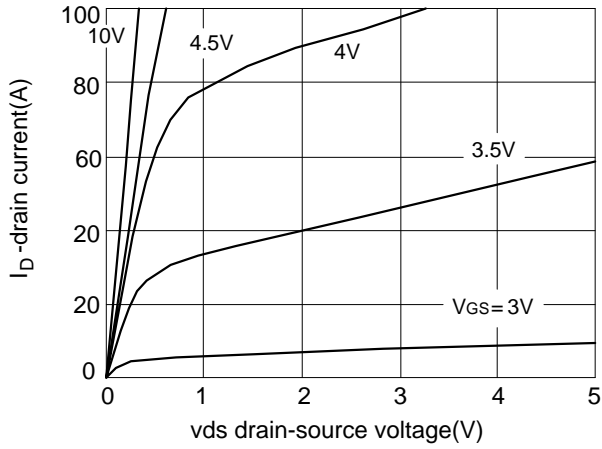

Fig.1 output characteristics

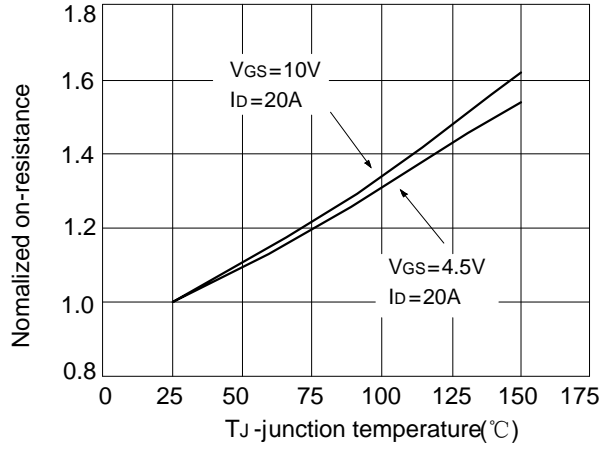

Fig.2 rdson-junction temperature

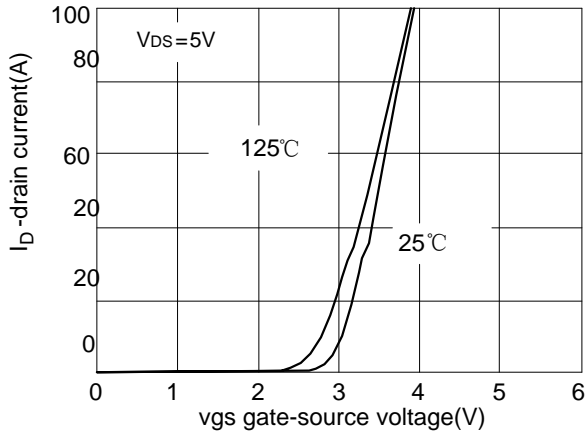

Fig.3 transfer characteristics

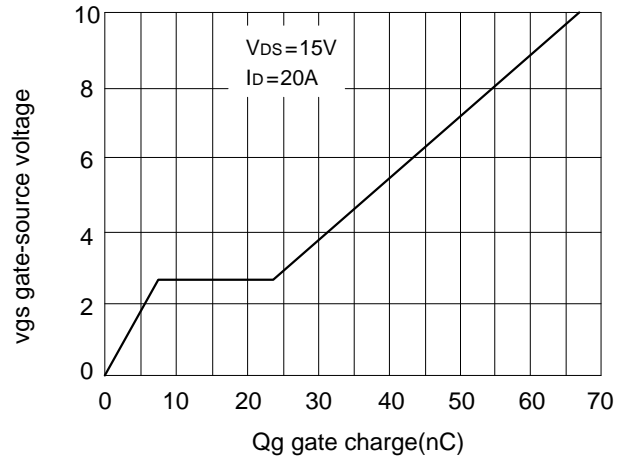

Fig.4 gate charge

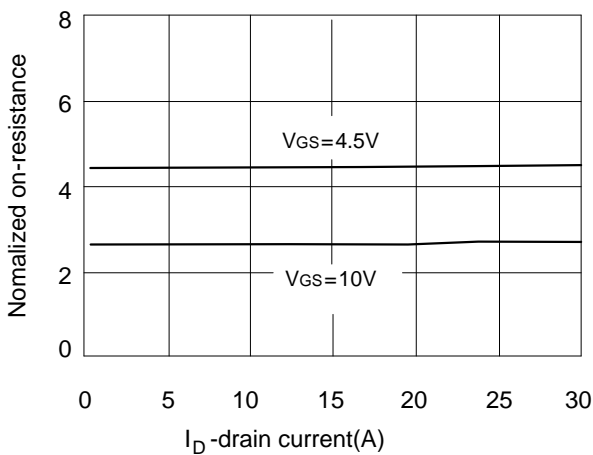

Fig.5 rdson-drain current

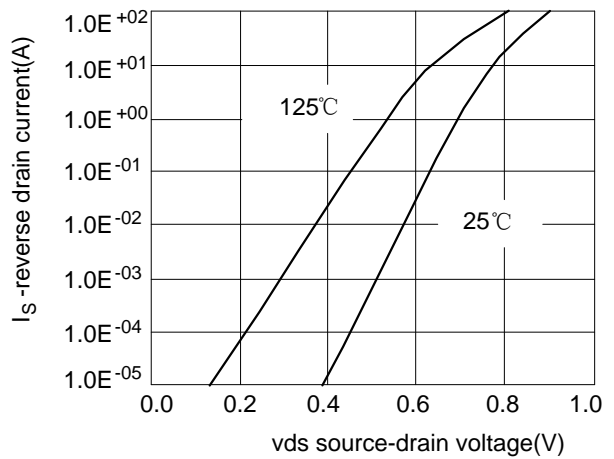
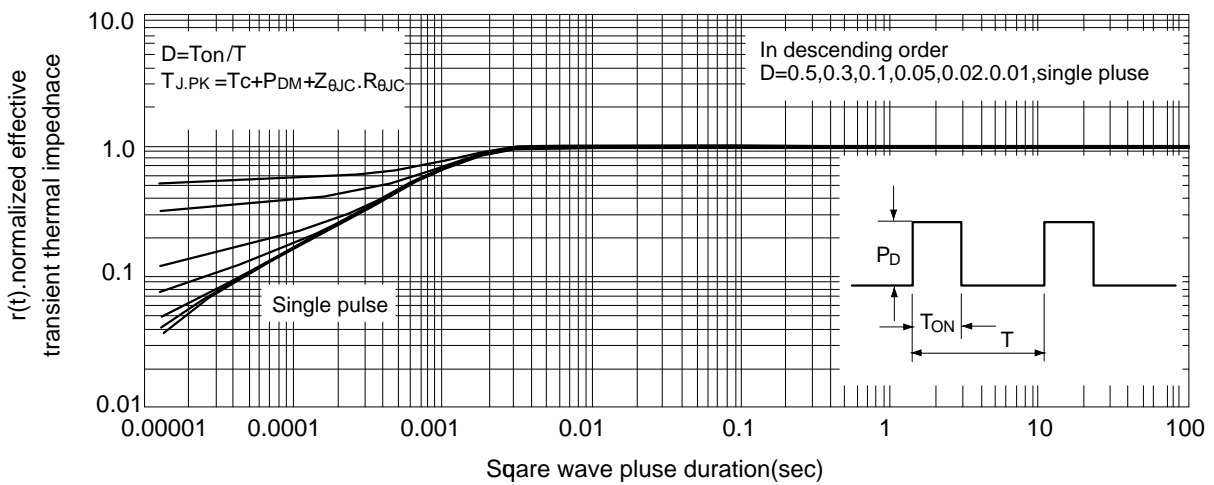
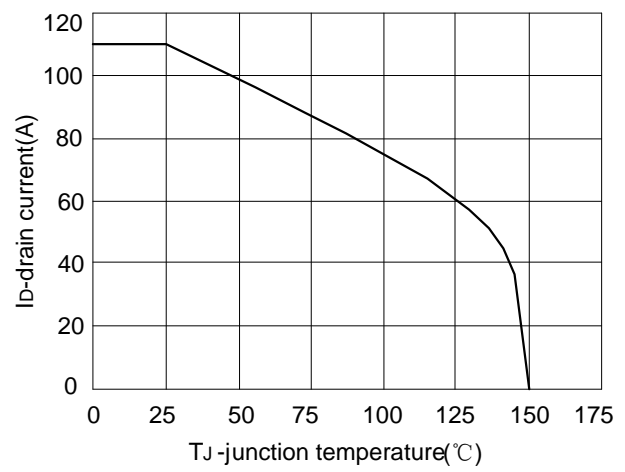
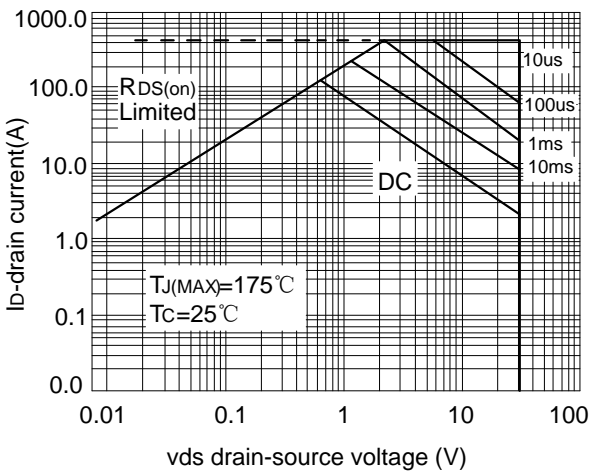
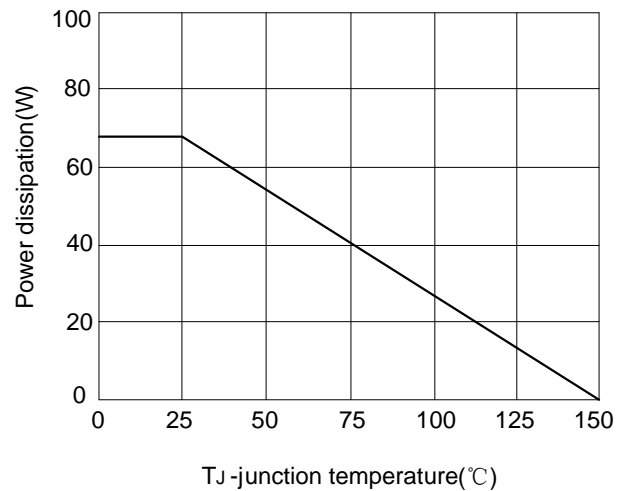
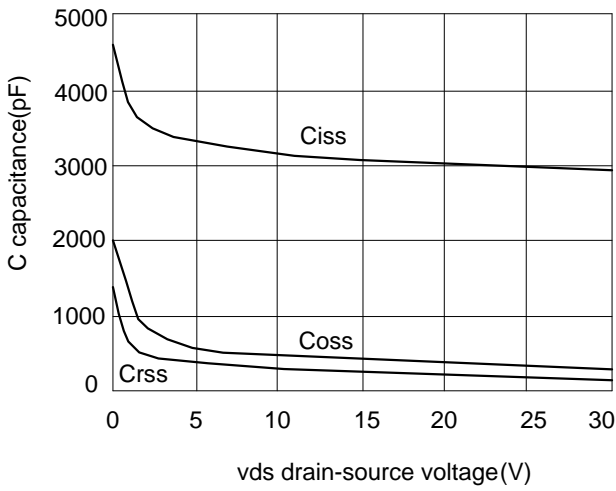
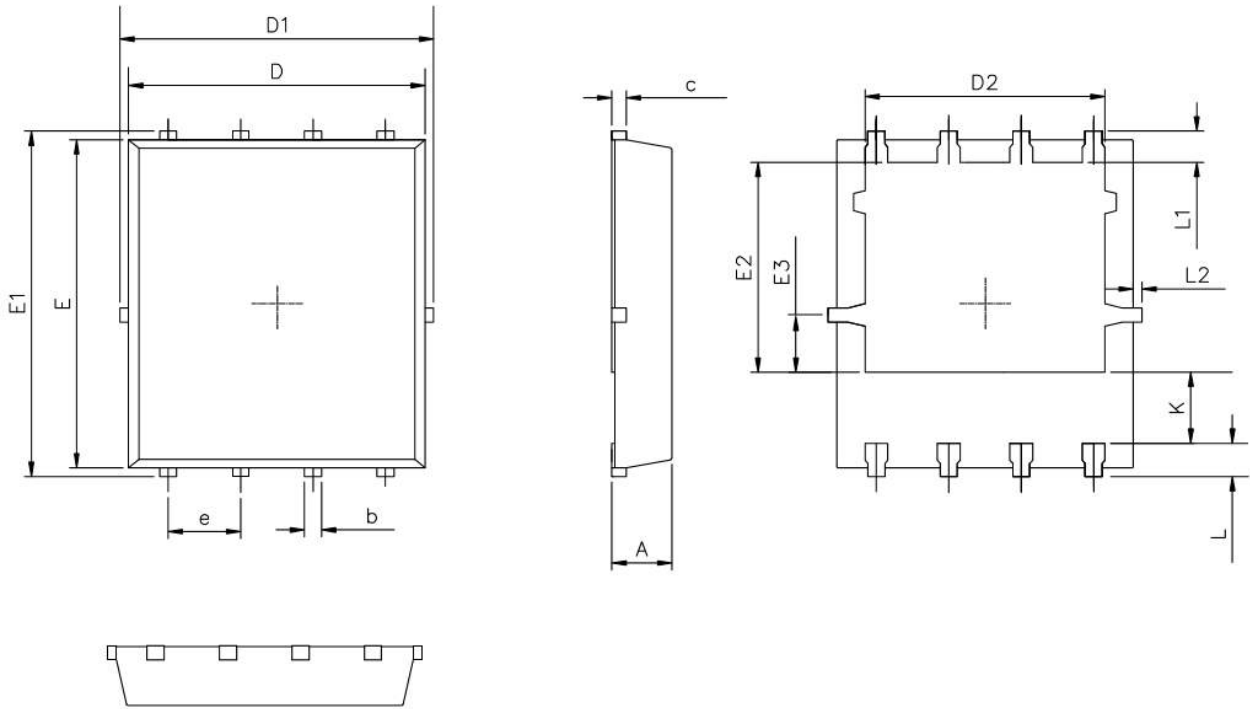

Fig.6 source-drain diode forward

■ TYPICAL CHARACTERISTICS(Cont.)



■ PDFN5X6-8L PACKAGE MECHANICAL DATA



RECOMMENDED LAND PATTERN

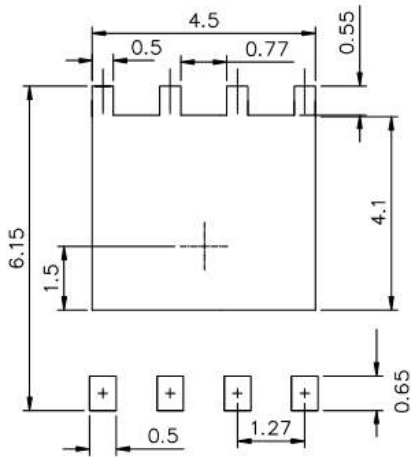

UNIT:mm

	MIN	NOM	MAX
A	0.90	1.00	1.10
b	0.25	0.35	0.50
c	0.10	0.20	0.30
D	4.80	5.00	5.30
D1	4.90	5.10	5.50
D2	3.92	4.02	4.20
E	5.65	5.75	5.85
E1	5.90	6.05	6.20
E2	3.325	3.525	3.775
E3	0.80	0.90	1.00
e		1.27	
L	0.40	0.55	0.70
L1		0.65	
L2	0.00		0.15
K	1.00	1.30	1.50