

■ PRODUCT CHARACTERISTICS

VDSS	650V
$R_{DS(on)Typ}(@V_{GS}=10V)$	0.53Ω
Qg@type	13nC
ID	7A

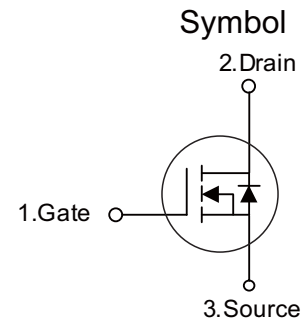

■ APPLICATIONS

- * Power factor correction
- * Switched mode power supplies
- * Uninterruptible power supply

■ FEATURES

- * low $R_{DS(on)}$
- * low gate charge
- * RoHS compliant

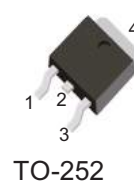

■ ORDER INFORMATION

Order codes		Package	Packing
Halogen-Free	Halogen		
N/A	MOT65R600C	TO-251	70 pieces/Tube
N/A	MOT65R600D	TO-252	2500 pieces/Reel

■ ABSOLUTE MAXIMUM RATINGS ($T_C=25^{\circ}C$ unless otherwise specified)

Parameter	Symbol	Value	Unit
Drain-Source Voltage ($V_{GS} = 0V$)	V_{DSS}	650	V
Continuous Drain Current	I_D	$T_C = 25^{\circ}C$	7
		$T_C = 100^{\circ}C$	4.2
Pulsed Drain Current (note1)	I_{DM}	21	A
Gate-Source Voltage	V_{GSS}	±30	V
Single Pulse Avalanche Energy (note2)	E_{AS}	142	mJ
Repetitive Avalanche Energy (note2)	E_{AR}	0.21	mJ
Avalanche Current	I_{AR}	1.3	A
MOSFET dv/dt ruggedness,	dv/dt	50	V/ns
Power Dissipation	P_D	63	W
Continuous Body Diode Current	I_S	6	A
Pulsed Diode Forward Current (note1)	I_{SM}	21	
Reverse diode dv/dt (note3)	dv/dt	15	V/ns
Maximum diode commutation speed (note3)	di/dt	500	A/us
Operating Junction and Storage Temperature Range	T_J, T_{stg}	-55~+150	°C

■ THERMAL CHARACTERISTICS

Parameter	Symbol	Value	Unit
Thermal resistance, junction-case max	R_{thjc}	2	°C/W
Thermal resistance, junction-ambient max	R_{thja}	62	°C/W

■ ELECTRICAL CHARACTERISTICS ($T_J = 25^\circ\text{C}$, unless otherwise specified)

Parameter	Symbol	Test conditions	Value			Unit
			Min.	Typ.	Max.	
Static						
Drain-Source Breakdown Voltage	$V_{(BR)DSS}$	$V_{GS} = 0V, I_D = 250\mu A$	650	--	--	V
Zero Gate Voltage Drain Current	I_{DSS}	$V_{DS} = 650V, V_{GS} = 0V, T_J = 25^\circ\text{C}$	--	--	1	μA
		$V_{DS} = 650V, V_{GS} = 0V, T_J = 150^\circ\text{C}$	--	--	100	
Gate-Source Leakage	I_{GSS}	$V_{GS} = \pm 30V$	--	--	± 100	nA
Gate-Source Threshold Voltage	$V_{GS(th)}$	$V_{DS} = V_{GS}, I_D = 250\mu A$	2.5	--	4.0	V
Drain-Source On-Resistance	$R_{DS(on)}$	$V_{GS} = 10V, I_D = 3.5A$	--	0.53	0.6	Ω
Gate resistance	R_G	$f = 1.0\text{MHz}$ open drain	--	19	--	Ω
Dynamic						
Input Capacitance	C_{iss}	$V_{GS} = 0V,$ $V_{DS} = 100V,$ $f = 1.0\text{MHz}$	--	509	--	pF
Output Capacitance	C_{oss}		--	23	--	
Reverse Transfer Capacitance	C_{riss}		--	1.5	--	
Total Gate Charge	Q_g	$V_{DD} = 520V, I_D = 7A,$ $V_{GS} = 10V$	--	13	--	nC
Gate-Source Charge	Q_{gs}		--	2.8	--	
Gate-Drain Charge	Q_{gd}		--	5.6	--	
Turn-on Delay Time	$t_{d(on)}$	$V_{DD} = 400V, I_D = 7A,$ $R_G = 25\Omega$	--	55	--	ns
Turn-on Rise Time	t_r		--	61	--	
Turn-off Delay Time	$t_{d(off)}$		--	117	--	
Turn-off Fall Time	t_f		--	42	--	
Drain-Source Body Diode Characteristics						
Body Diode Voltage	V_{SD}	$T_J = 25^\circ\text{C}, I_{SD} = 3.5A, V_{GS} = 0V$	--	0.9	1.2	V
Reverse Recovery Time	t_{rr}	$V_R = 400V, I_F = 7A,$ $di_F/dt = 100A/\mu s$	--	321	--	ns
Reverse Recovery Charge	Q_{rr}		--	3.4	--	μC
Peak Reverse Recovery Current	I_{rrm}		--	21.2	--	A

Notes

1. Repetitive Rating: Pulse width limited by maximum junction temperature
2. $I_{AS} = 2.4A, V_{DD} = 50V, R_G = 25\Omega$, Starting $T_J = 25^\circ\text{C}$
3. Identical low side and high side switch with identical R_G

■ TEST CIRCUITS AND WAVEFORMS

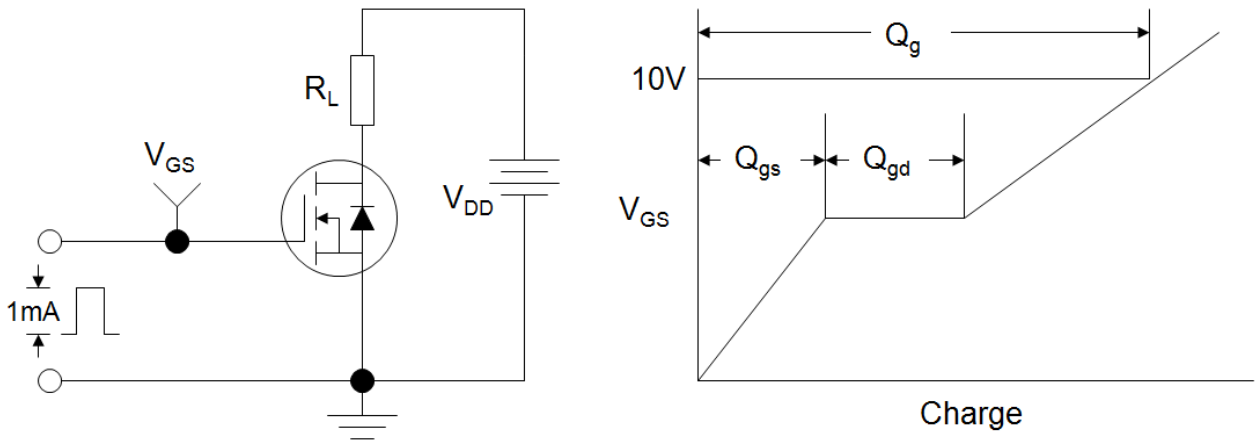

Figure A: Gate Charge Test Circuit and Waveform

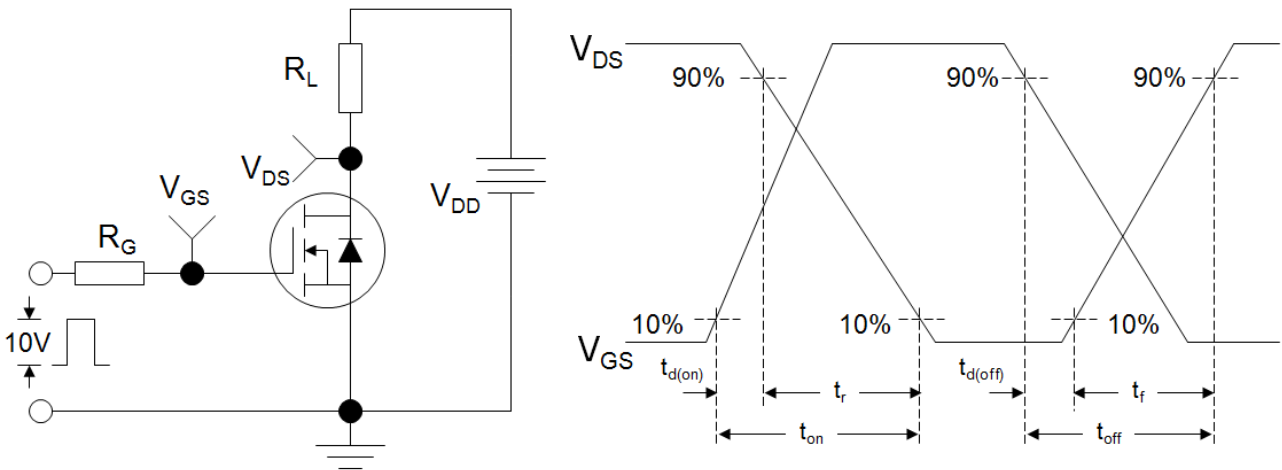

Figure B: Resistive Switching Test Circuit and Waveform

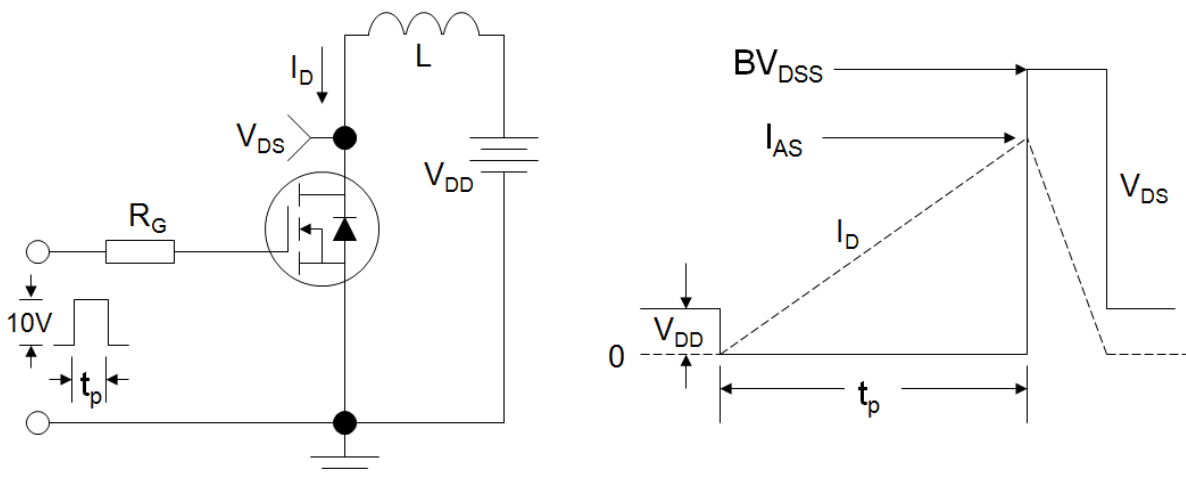

Figure C: Unclamped Inductive Switching Test Circuit and Waveform

■ TYPICAL CHARACTERISTICS

Figure 1. Output Characteristics

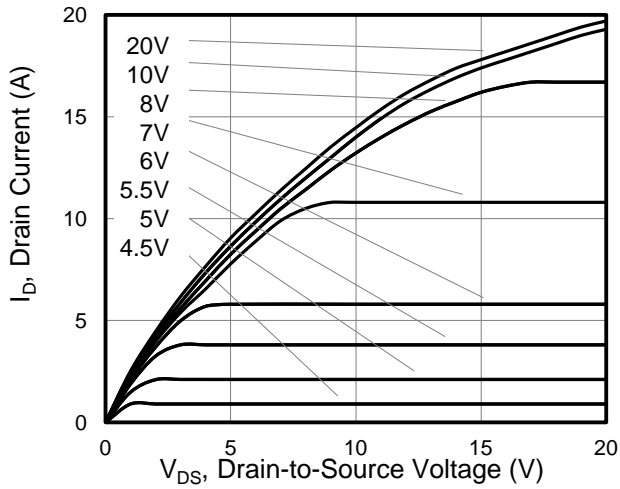

Figure 2. Transfer Characteristics

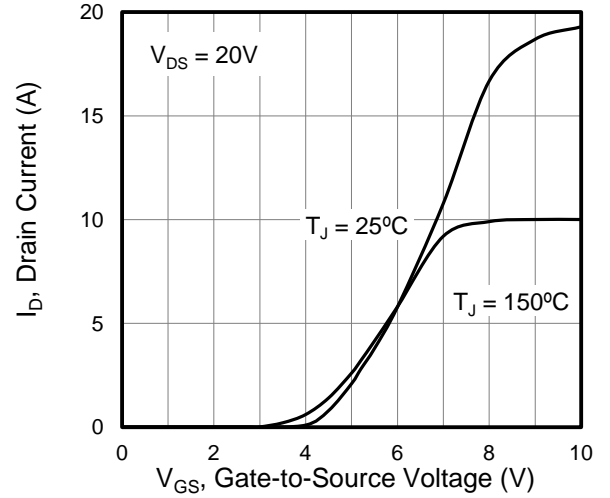

Figure 3. On-Resistance vs. Drain Current

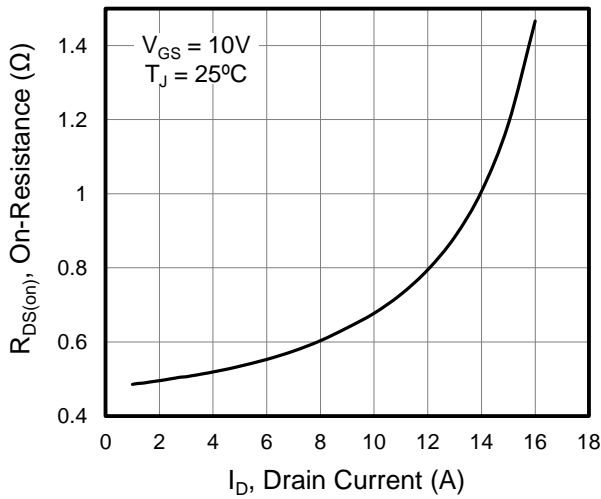

Figure 4. Capacitance

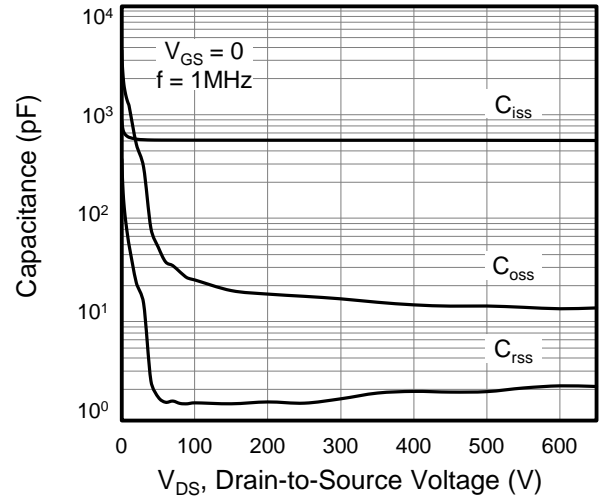

Figure 5. Gate Charge

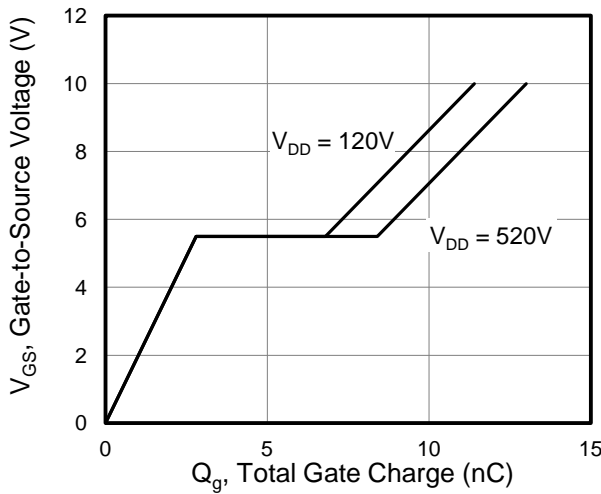
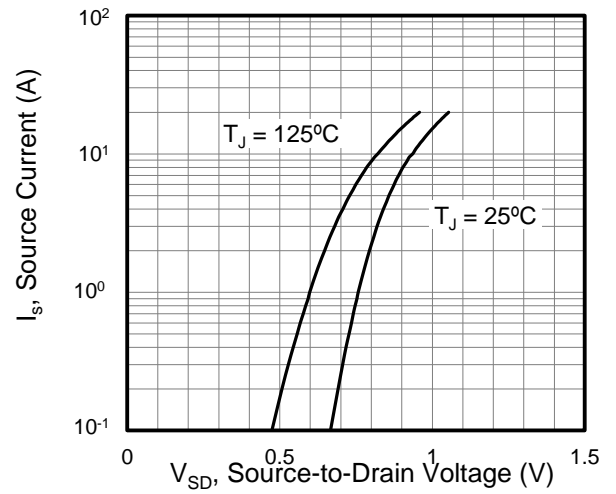

Figure 6. Body Diode Forward Voltage



■ TYPICAL CHARACTERISTICS(Cont.)

Figure 7. On-Resistance vs. Junction Temperature

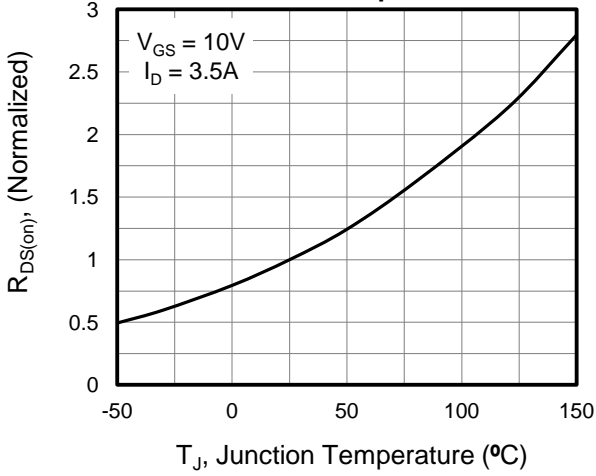

Figure 8. Breakdown voltage vs. Junction Temperature

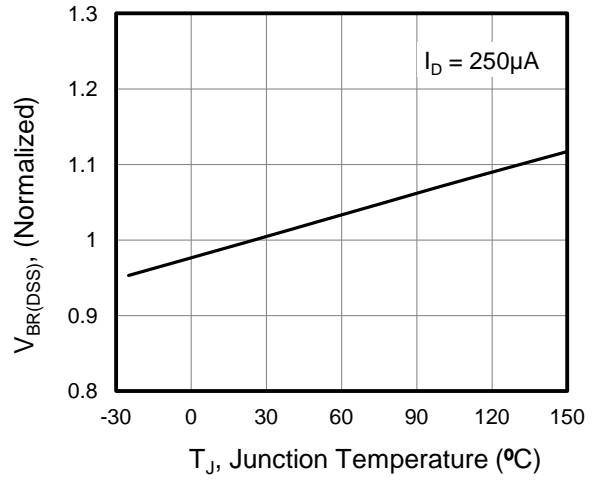

Figure 9. Transient Thermal Impedance TO-252

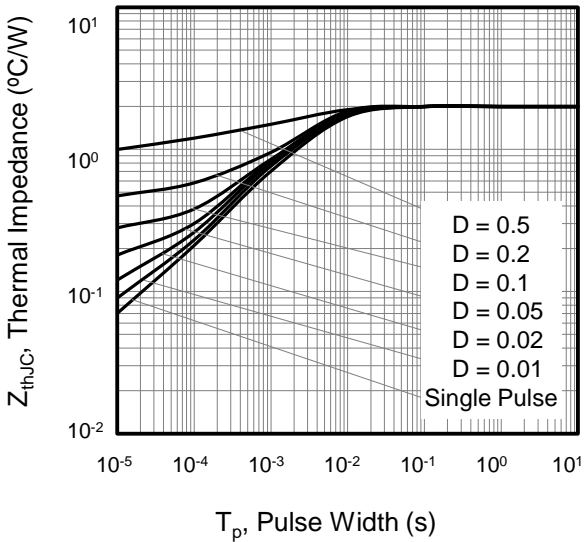
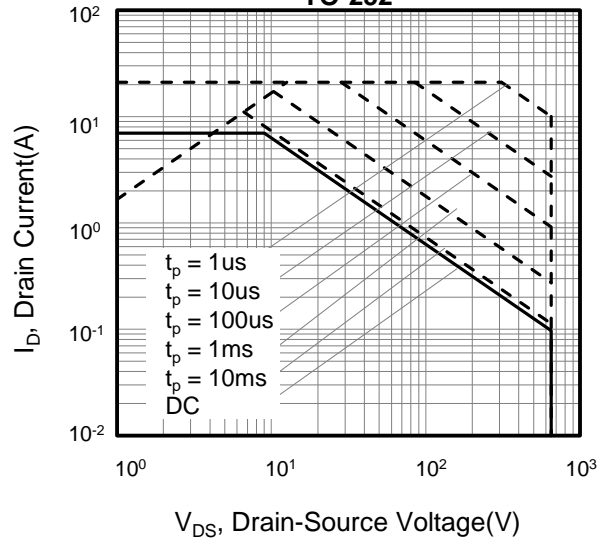
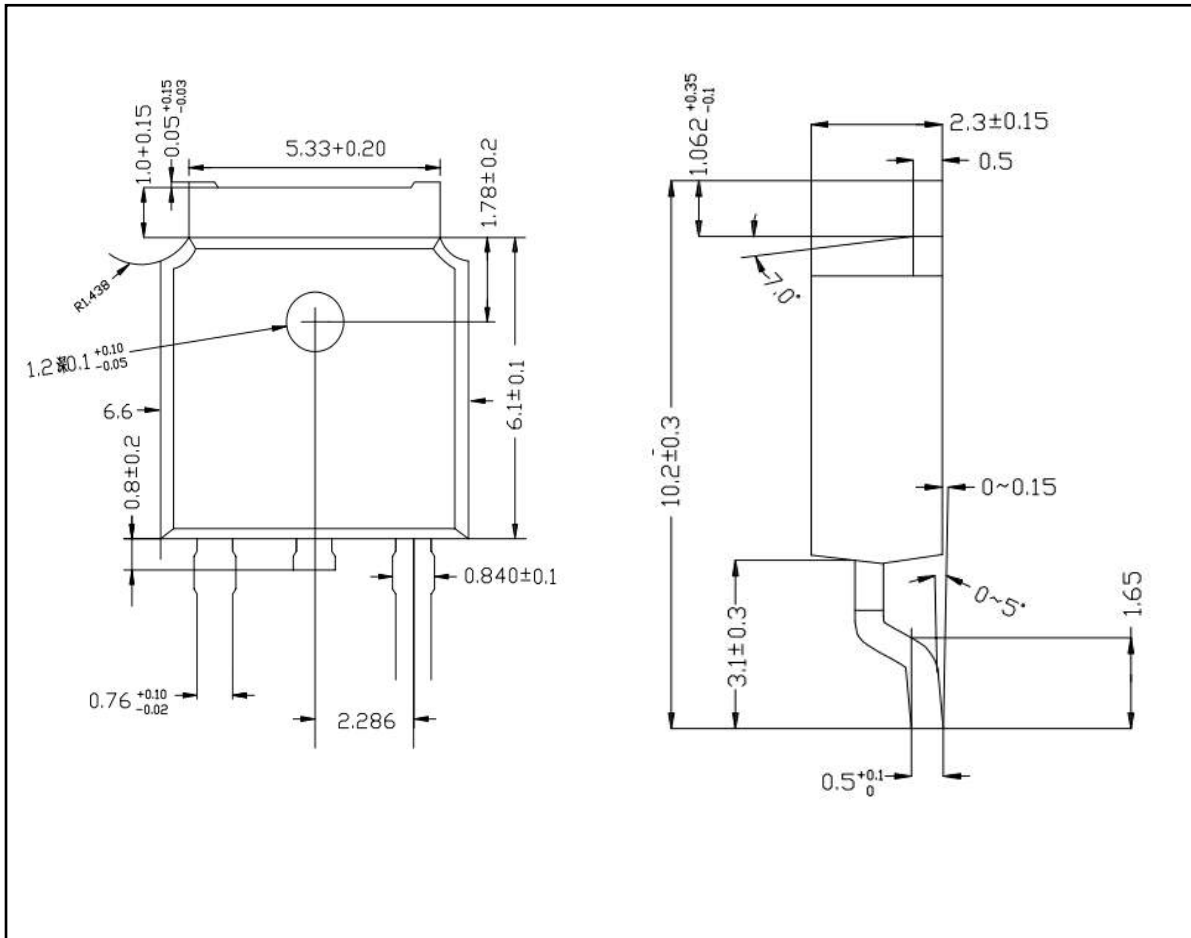

Figure 10. Safe operation area for TO-252



■ TO-252-2L PACKAGE OUTLINE DIMENSIONS



■ TO-251-3L PACKAGE OUTLINE DIMENSIONS

