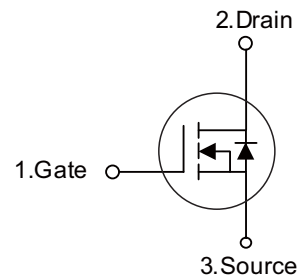

PRODUCT CHARACTERISTICS

VDSS	650V
$R_{DS(on)}$ Typ(@ $V_{GS}=10V$)	0.23 Ω
Qg@type	19nC
ID	15A

Symbol

FEATURES

- Ultra low $R_{DS(on)}$
- Ultra low gate charge (typ. $Q_g = 19$ nC)
- 100% UIS tested
- RoHS compliant

APPLICATIONS

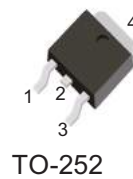
- Power facion correction
- Switched mode power supplies
- Uninterruptible power supply



TO-252

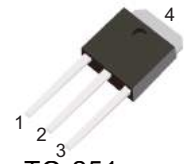

TO-251

ORDER INFORMATION

Order codes		Package	Packing
Halogen-Free	Halogen		
N/A	MOT65R280C	TO-251	70 pieces/Tube
N/A	MOT65R280D	TO-252	2500preces/reel

ABSOLUTE MAXIMUM RATINGS

Parameter	Symbol	Value	Unit
Drain-Source Voltage ($V_{GS} = 0V$)	V_{DSS}	650	V
Continuous Drain Current	I_D	15	A
Pulsed Drain Current	I_{DM}	45	A
Gate-Source Voltage	V_{GSS}	± 30	V
Single Pulse Avalanche Energy	E_{AS}	290	mJ
Avalanche Current	I_{AS}	2.4	A
MOSFET dv/dt ruggedness, $V_{DS} = 0 \dots 480V$	dv/dt	50	V/ns
Reverse diode dv/dt, $V_{DS} = 0 \dots 480V$, $I_{SD} \leq I_D$	dv/dt	15	V/ns
Power Dissipation ($T_C = 25^\circ C$)	P_D	104	W
Operating Junction and Storage Temperature Range	T_J, T_{stg}	-55~+150	$^\circ C$

THERMAL CHARACTERISTICS

Parameter	Symbol	Value	Unit
Thermal Resistance, Junction-to-Case	$R_{\theta JC}$	1.2	$^\circ C/W$
Thermal Resistance, Junction-to-Ambient	$R_{\theta JA}$	62	$^\circ C/W$

■ ELECTRICAL CHARACTERISTICS

Parameter	Symbol	Test conditions	Min.	Typ.	Max.	Unit
Drain-Source Breakdown Voltage	$V_{(BR)DSS}$	$V_{GS} = 0V, I_D = 250\mu A$	650	--	--	V
Zero Gate Voltage Drain Current	I_{DSS}	$V_{DS} = 650V, V_{GS} = 0V, T_J = 25^\circ C$	--	--	1	μA
		$V_{DS} = 650V, V_{GS} = 0V, T_J = 150^\circ C$	--	--	100	
Gate-Source Leakage	I_{GSS}	$V_{GS} = \pm 30V$	--	--	± 100	nA
Gate-Source Threshold Voltage	$V_{GS(th)}$	$V_{DS} = V_{GS}, I_D = 250\mu A$	2.5	--	4.0	V
Drain-Source On-Resistance (Note3)	$R_{DS(on)}$	$V_{GS} = 10V, I_D = 7.5A$	--	0.23	0.28	Ω
Forward Transconductance (Note3)	g_{fs}	$V_{DS} = 10V, I_D = 7.5A$	--	10	--	S
Dynamic						
Input Capacitance	C_{iss}	$V_{GS} = 0V,$ $V_{DS} = 50V,$ $f = 1.0MHz$	--	1250	--	μF
Output Capacitance	C_{oss}		--	81	--	
Reverse Transfer Capacitance	C_{rss}		--	7.1	--	
Total Gate Charge	Q_g	$V_{DD} = 520V, I_D = 15A,$ $V_{GS} = 10V$	--	30	--	nC
Gate-Source Charge	Q_{gs}		--	9	--	
Gate-Drain Charge	Q_{gd}		--	10	--	
Turn-on Delay Time	$t_{d(on)}$	$V_{DD} = 400V, I_D = 15A,$ $R_G = 25\Omega$	--	42	--	ns
Turn-on Rise Time	t_r		--	17	--	
Turn-off Delay Time	$t_{d(off)}$		--	135	--	
Turn-off Fall Time	t_f		--	6	--	
Drain-Source Body Diode Characteristics						
Continuous Body Diode Current	I_S	$T_C = 25^\circ C$	--	--	15	A
Pulsed Diode Forward Current	I_{SM}		--	--	45	
Body Diode Voltage	V_{SD}	$T_J = 25^\circ C, I_{SD} = 15A, V_{GS} = 0V$	--	0.9	1.2	V
Reverse Recovery Time	t_{rr}	$V_R = 480V, I_F = I_S,$ $di_F/dt = 100A/\mu s$	--	335	--	ns
Reverse Recovery Charge	Q_{rr}		--	3.4	--	μC
Peak Reverse Recovery Current	I_{rrm}		--	20	--	A

Notes

1. Repetitive Rating: Pulse Width limited by maximum junction temperature
2. $I_{AS} = 2.4A, V_{DD} = 50V, R_G = 25\Omega, \text{Starting } T_J = 25^\circ C$
3. Pulse Test: Pulse Width $\leq 300\mu s, \text{Duty Cycle } \leq 1\%$

■ ELECTRICAL CHARACTERISTICS

Figure 1. Output Characteristics

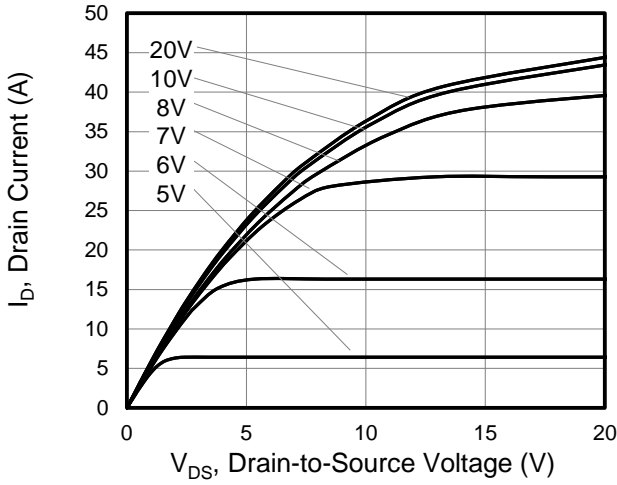

Figure 2. Transfer Characteristics

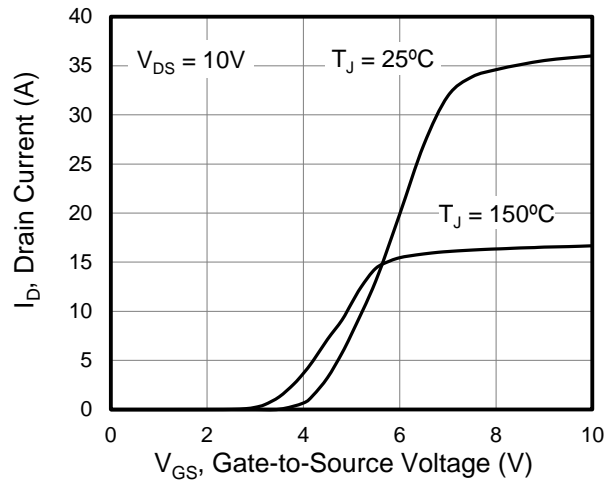

Figure 3. On-Resistance vs. Drain Current

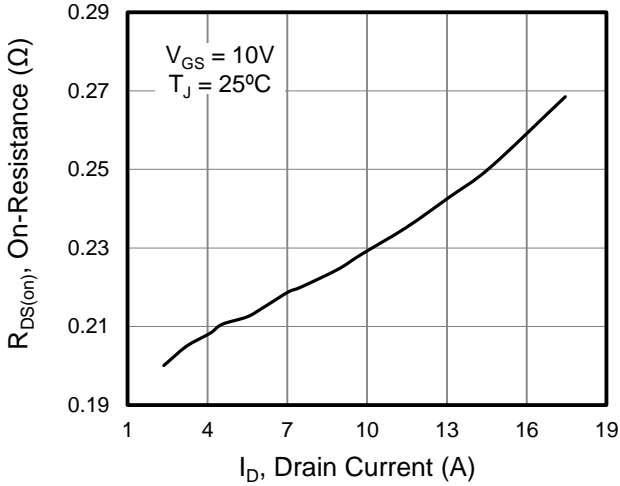

Figure 4. Capacitance

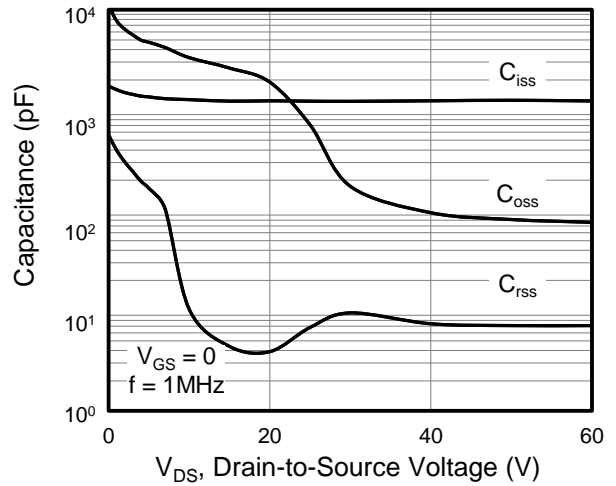

Figure 5. Gate Charge

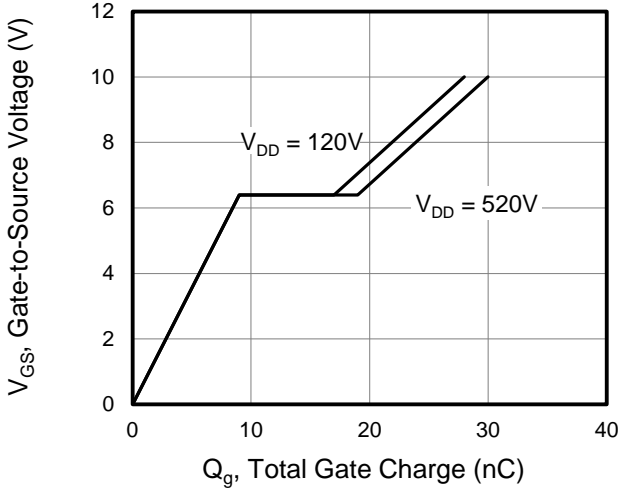
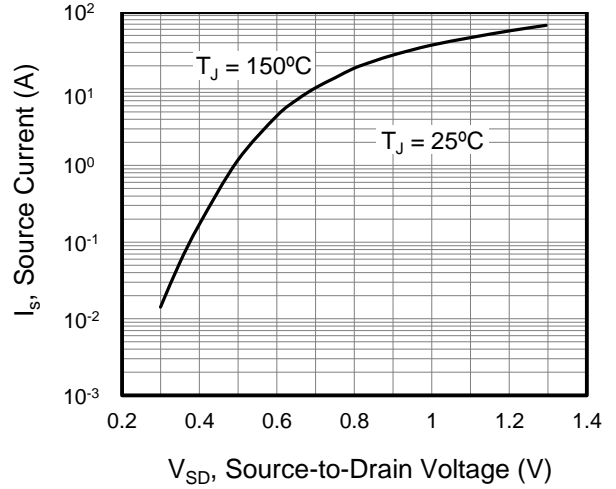

Figure 6. Body Diode Forward Voltage



■ ELECTRICAL CHARACTERISTICS(Cont.)

Figure 7. On-Resistance vs. Junction Temperature

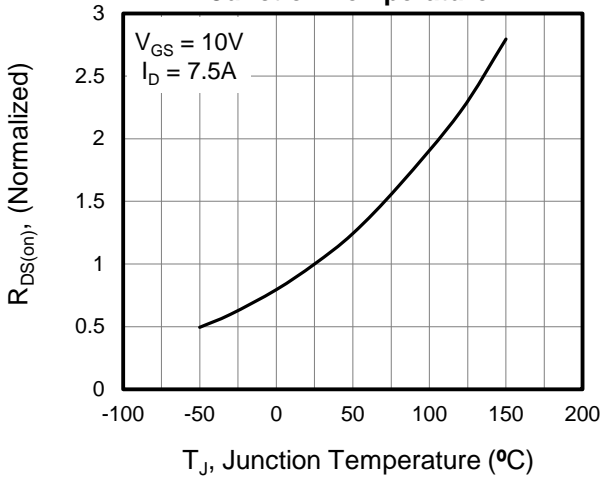

Figure 8. Threshold Voltage vs. Junction Temperature

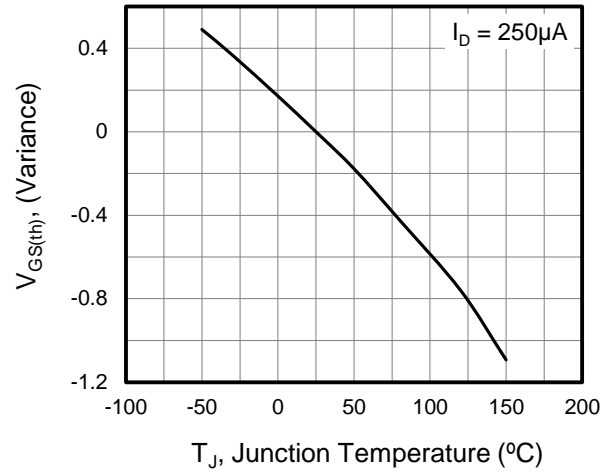

Figure 9. Transient Thermal Impedance TO-220,TO-251,TO-252,TO-262,TO-263

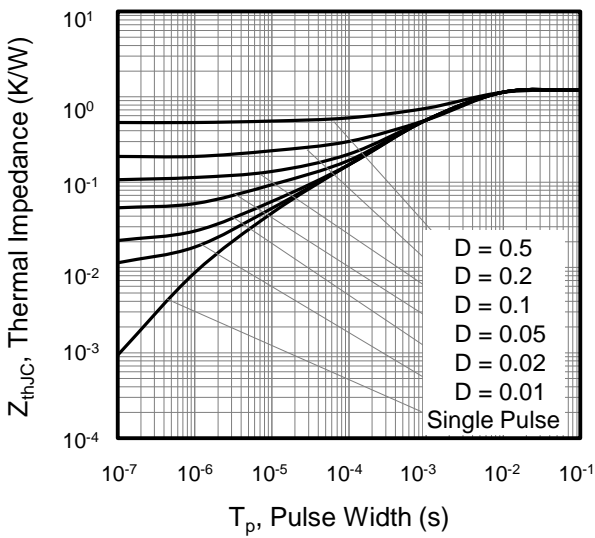

Figure 10. Transient Thermal Impedance TO-220F

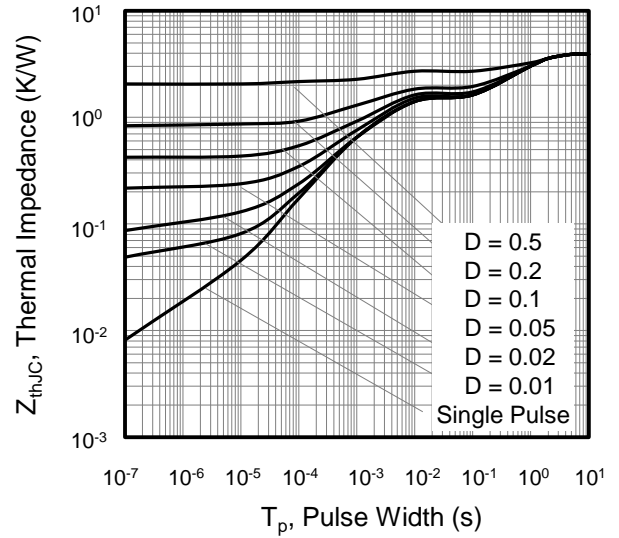

Figure 11. Safe operation area for TO-220,TO-251,TO-252,TO-262,TO-263

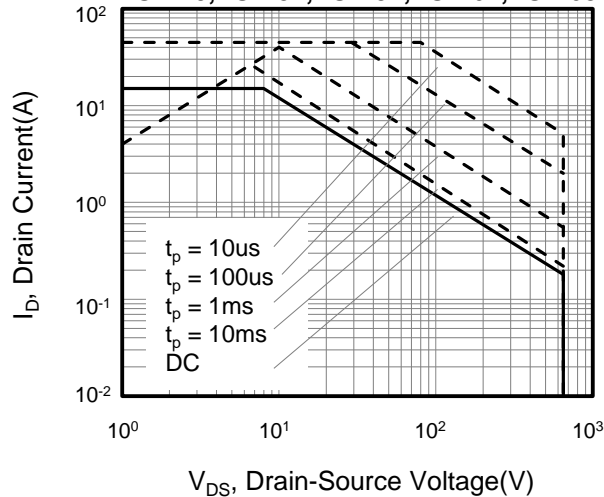
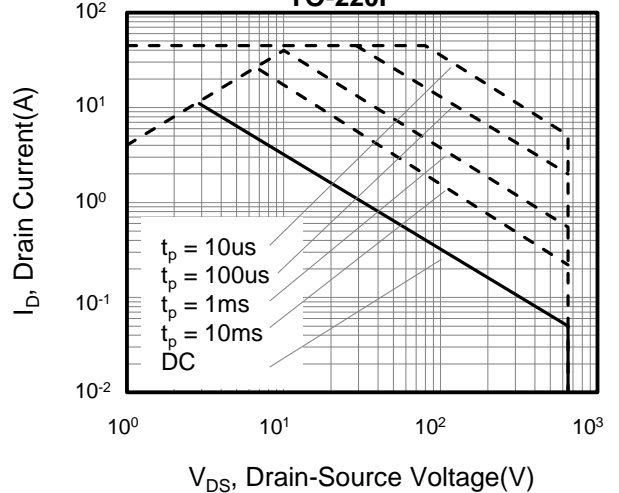

Figure 12. Safe operation area for TO-220F



■ GATE CHARGE TEST CIRCUIT WAVEFORM

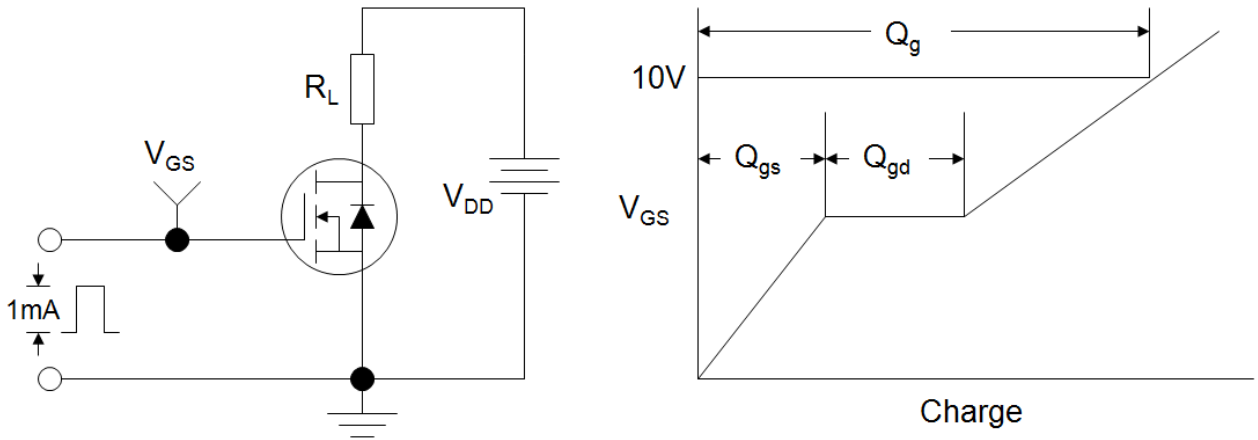

Figure B: Resistive Switching Test Circuit and Waveform

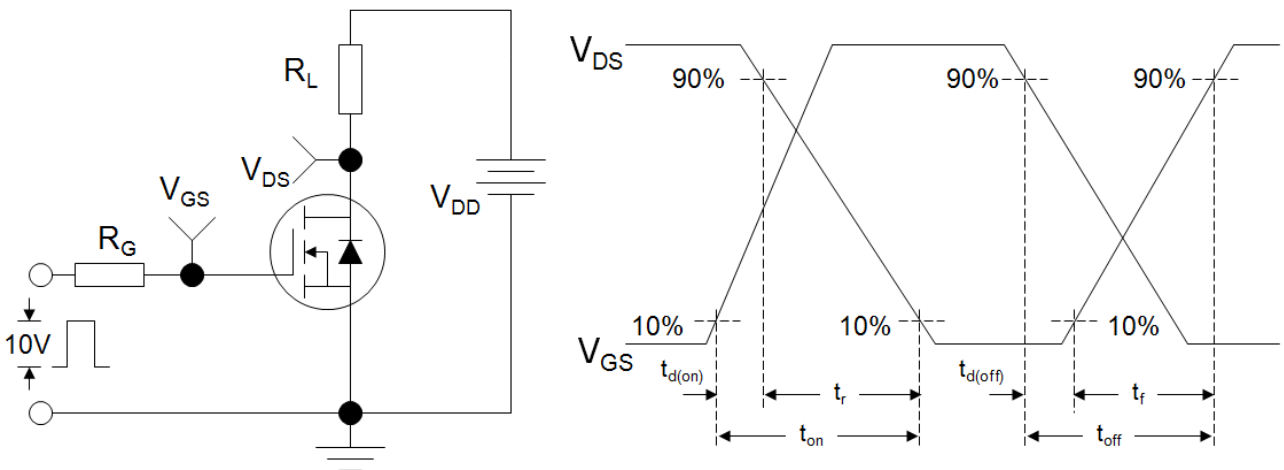
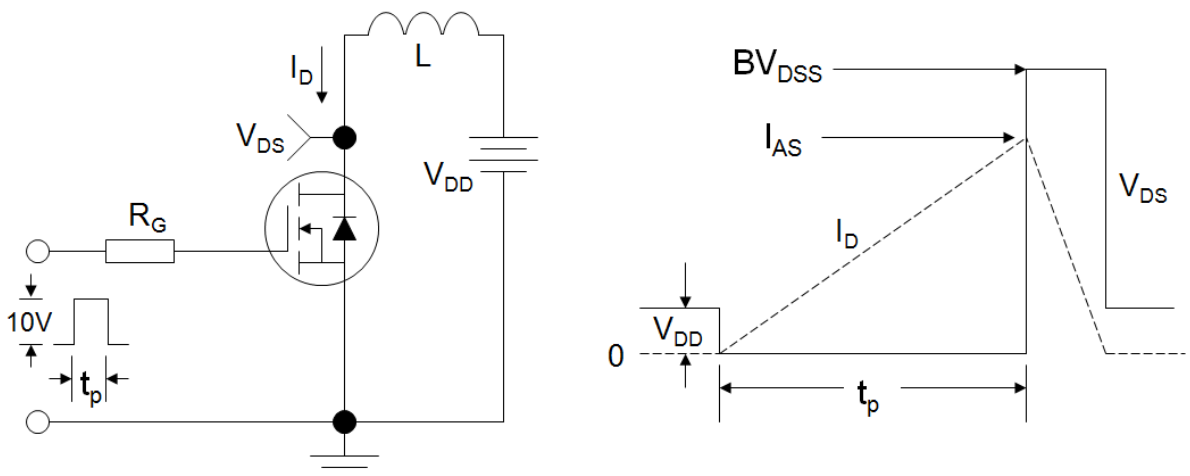
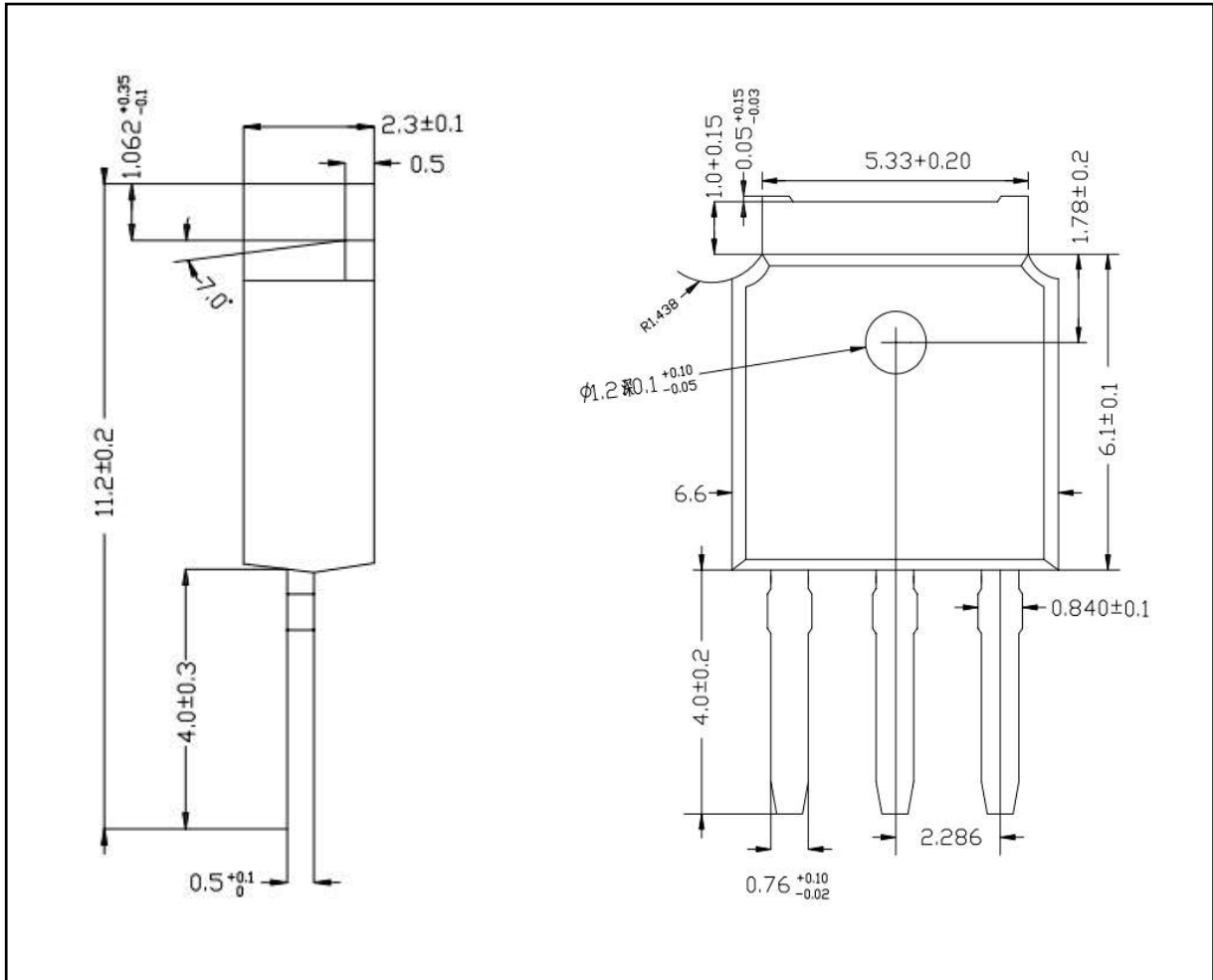

Figure C: Unclamped Inductive Switching Test Circuit and Waveform



■ TO-251-3L PACKAGE OUTLINE DIMENSIONS



■ TO-252-2L PACKAGE OUTLINE DIMENSIONS

